



Husqvarna[®]
READY WHEN YOU ARE

PROFESSIONAL PRODUCTS 2021





THE PROFESSIONALS REPRESENTING OUR BRAND. MEET THE H-TEAM AMBASSADORS

Andy Campbell – Forestry (left)

Andy has spent most of his working life in the forest. When not logging or running chainsaw training courses he may be found training for and competing in precision chainsaw competitions both here in the UK and abroad. He has represented the UK in all 5 of the European Logging Championships since they started in 2009. Andy is chairman of the UK Loggers, who send a team to represent the UK in the World Logging Championships where he has attended as team leader for numerous years. The UK Loggers also run our annual national precision chainsaw championship. Andy is also a Technical Standards Verifier for Lantra Awards and an assessor for City and Guilds certificates of competence.

Josephine Hedger – Arboriculture (centre)

Multiple World and European Tree Climbing Champion and former foot locking world record holder. As well as regularly competing globally, Josephine runs a successful arborist business with her husband, employing 10 people and also runs an Arboriculture training school. Josephine is extremely passionate about climbing and the Arboriculture industry.

Tim Bendle – Forestry & Arboriculture (right)

Tim has 34 years experience working as a professional contractor in the Forestry & Arboriculture Industry. Tim's extensive experience stretches to 25 years as a City & Guilds NPTC Assessor and Lantra Instructor in Forestry and Arboriculture. Tim is also one of the Principal Technical Standards Verifiers for City & Guilds NPTC and a long standing Lantra Technical Standards Verifier for Forestry and Arboriculture. Tim performs independent training and also is contracted to the Royal Agricultural University, Cirencester covering all chainsaw, climbing and forestry/arboriculture machinery activities. Tim has enjoyed a close working relationship with Husqvarna for the last 25 years and feels passionate about the brand and its continued support to the Forestry & Arboriculture Industry.





SHARE your stories and photos on your Facebook, Instagram and Twitter by tagging us.



HusqvarnaUK



UK_Husqvarna



HusqvarnaUK / HusqvarnaGardenUK



Husqvarna tools for forests, parks and gardens are born from a unique relationship between man, machine and nature – between our company and the people who use our equipment to shape nature every day. Dedicated people, who need the very best tools and machines to achieve the very best results.

When the going gets tough, Husqvarna tools are tougher. When work gets hard, they're lighter, more comfortable to handle and easier to use. Yet they always affect your surroundings as little as possible when it comes to noise and pollution. Our job is to make you better and make sure you get the job done – smarter, easier and more efficient and safe than ever.

Find more possibilities at www.husqvarna.com/uk

**READY
WHEN
YOU ARE**

NEW FOR 2021

129



**AUTOMOWER® 550
EPOS**

143



P 535HX

CONTENTS

| | |
|-------------------------------|-----|
| BATTERY SERIES | 10 |
| CHAINSAWS | 36 |
| BARS & CHAINS | 52 |
| FORESTRY AND ARBORIST TOOLS | 62 |
| TRIMMERS & BRUSHCUTTERS | 70 |
| COMBI MACHINES | 84 |
| CUTTING EQUIPMENT | 90 |
| HEDGE TRIMMERS | 96 |
| BLOWERS | 106 |
| POWER CUTTERS | 114 |
| COMMERCIAL ROBOTIC MOWERS | 118 |
| COMMERCIAL FRONT MOWERS | 134 |
| LAWN MOWERS | 148 |
| HUSQVARNA FLEET SERVICES™ | 158 |
| HUSQVARNA SERVICE | 162 |
| PERSONAL PROTECTIVE EQUIPMENT | 164 |
| FUEL, OILS & LUBRICANTS | 179 |
| XPLORER LEISUREWEAR | 184 |
| HUSQVARNA MERCHANDISE | 188 |



A large, gnarled tree branch dominates the right side of the frame, extending from the top right towards the center. The background is a soft, hazy sunset sky with warm orange and yellow tones. The overall mood is professional and rugged.

DEDICATED TO THE TRUE PROFESSIONALS

Husqvarna's 500 series of products have been designed to perform. To deliver impressive results and to withstand tough usage day in, day out. No matter if you choose a battery powered or petrol powered machine, every detail has been developed with professional use in mind, to maximise performance and productivity and make easy work of the toughest of jobs. Year in, year out.

ALL YOU NEED TO GET IT DONE

No matter if you're tasked with trimming hedges, mowing wide expanses of grass or taking down an entire grove of trees, we can supply you with all that you need to do your job, efficiently and conveniently. In our range you'll find everything from professional handheld machines and lawn mowers to powerful chainsaws with optimised manoeuvrability. We're world leaders in robotic mowers that will produce the perfect cut while you spend your time on other tasks. And, naturally, we offer service and support to keep you up and running.

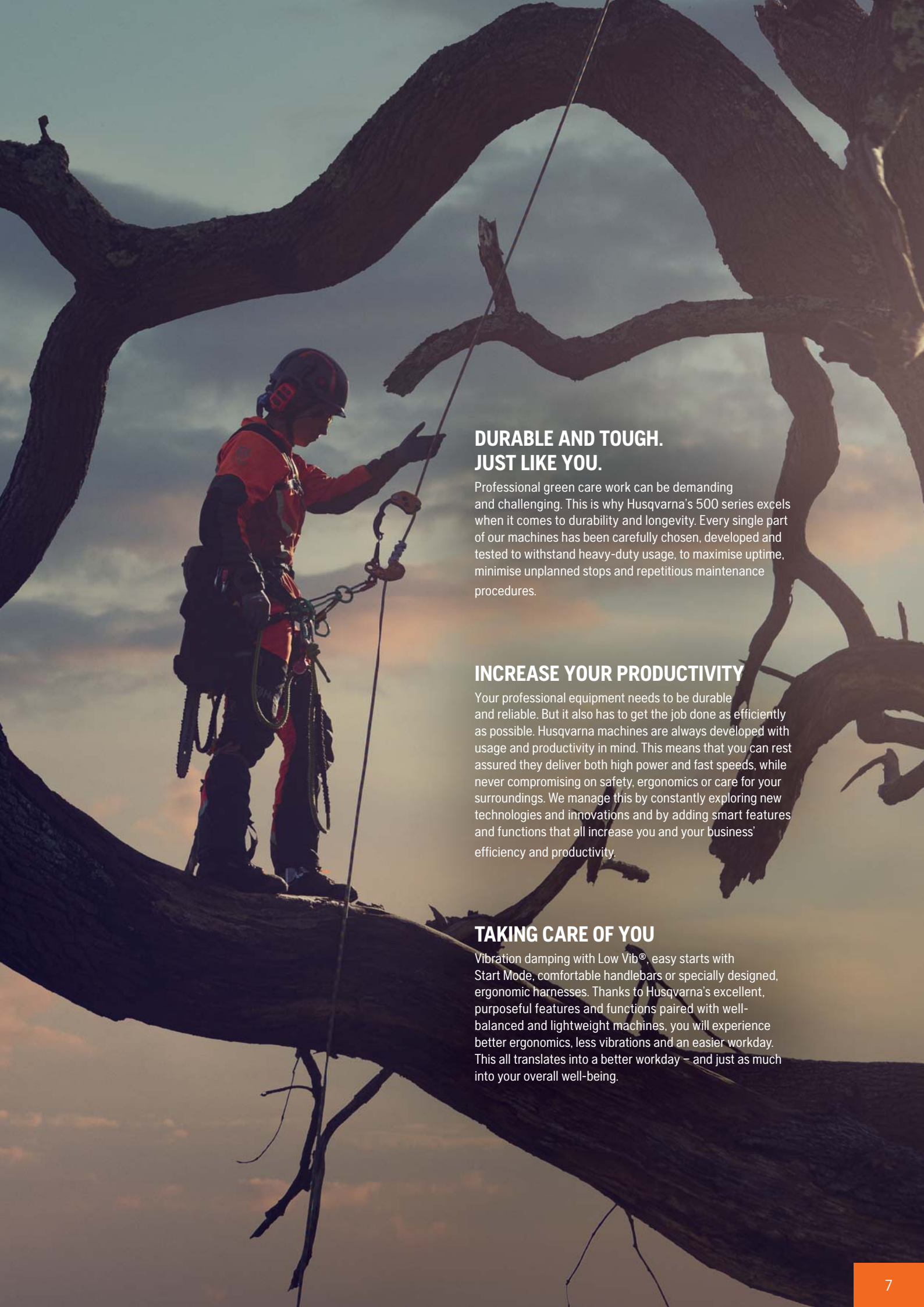

DURABLE AND TOUGH. JUST LIKE YOU.

Professional green care work can be demanding and challenging. This is why Husqvarna's 500 series excels when it comes to durability and longevity. Every single part of our machines has been carefully chosen, developed and tested to withstand heavy-duty usage, to maximise uptime, minimise unplanned stops and repetitious maintenance procedures.

INCREASE YOUR PRODUCTIVITY

Your professional equipment needs to be durable and reliable. But it also has to get the job done as efficiently as possible. Husqvarna machines are always developed with usage and productivity in mind. This means that you can rest assured they deliver both high power and fast speeds, while never compromising on safety, ergonomics or care for your surroundings. We manage this by constantly exploring new technologies and innovations and by adding smart features and functions that all increase you and your business' efficiency and productivity.

TAKING CARE OF YOU

Vibration damping with Low Vib[®], easy starts with Start Mode, comfortable handlebars or specially designed, ergonomic harnesses. Thanks to Husqvarna's excellent, purposeful features and functions paired with well-balanced and lightweight machines, you will experience better ergonomics, less vibrations and an easier workday. This all translates into a better workday – and just as much into your overall well-being.

THE POWER YOU NEED TO SUCCEED

No matter if you choose petrol or battery power, you can always rely on Husqvarna technology to deliver the required results. Characterised by our long and proud history of engineering, our 2-stroke engines and electric motors are all developed to maximise performance and durability. All to increase your productivity.

HUSQVARNA ELECTRICAL E-TORQ MOTORS

The unique Husqvarna E-TORQ motors are developed and produced by Husqvarna and are perfectly adapted for each application. The brushless design minimises the number of moving parts and the encapsulated motors are built to withstand tough, prolonged professional use, are completely maintenance-free and designed to last the entire product-life.

BRUSHLESS MOTORS – HIGH PERFORMANCE

The brushless motors deliver high constant torque from low rpms enough for the most demanding tasks. All to ensure uptime and productivity.

DESIGNED BY HUSQVARNA – MADE FOR A PERFECT FIT

Electric control units and batteries are all designed by Husqvarna. This means we can optimise the complete system, resulting in machines with low weight, slim design and excellent balance.

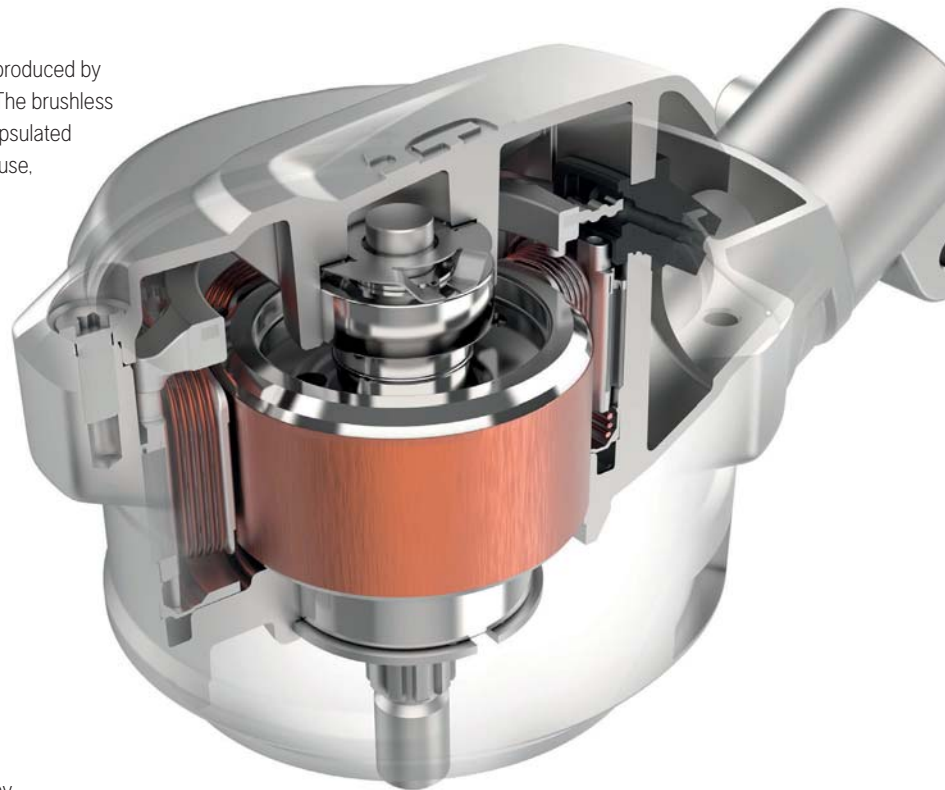

HIGH ENERGY – HIGH EFFICIENCY

To ensure a long runtime, efficient components with minimal energy losses are essential. All our motors, control units and batteries are developed with high efficiency in mind. This means that as much as possible of the energy within the battery is being utilised for real work.

HUSQVARNA 2-STROKE ENGINES

We've been refining the 2-stroke petrol engine ever since we started making motorcycles in 1903. This continuous strive for perfection has resulted in today's powerful, reliable and efficient engines. But we don't stop there. What really sets modern Husqvarna engines apart are their innovative features, features that make sure they deliver top performance in any conditions, while using every drop of fuel to the max.

X-TORQ® – BOOSTING ENERGY EFFICIENCY

X-Torq® engines deliver great combustion efficiency, with no compromise on power or torque. Every cycle, the cylinder is flushed with fresh air before the air/fuel mixture enters the cylinder, to prevent unburnt fuel from mixing with the exhausts. This translates into a daily user benefit, lowering emissions and saving on fuel, compared to previous models without X-Torq®.

QUICK, RELIABLE AND POWERFUL ACCELERATION

Husqvarna's professional 2-stroke engines are optimised to deliver maximum acceleration and high torque. When combined with a quick engine start, the acceleration will allow you to get the job done faster, never compromising on the output or reliability.



AUTOTUNE™

FULL ENGINE PERFORMANCE

With AutoTune™, you can always expect reliable starts and maximum performance from your Husqvarna. It's an automatic feature that constantly fine-tunes the air-fuel mixture, compensating for factors such as humidity, altitude, temperature, fuel quality and, not least, air filter clogging. Your engine runs perfectly – and you never have to tune the carburettor manually again.



**BATTERY
EXPERIENCE
SINCE 1973**
HUSQVARNA GROUP

DO ANY JOB WITHOUT NOISE OR EMISSIONS

The Husqvarna Battery Series offers all the power, performance and intuitive design you expect from Husqvarna. Our range of highly-efficient handheld products, driven by a powerful Li-ion battery pack, ensure that you get significantly less noise and vibrations, minimal maintenance – and no direct emissions at all. Also, you can switch batteries between machines, because Husqvarna batteries are interchangeable between all Husqvarna battery products.



WHAT YOU GET AND HOW WE DO IT



DON'T DISTURB

No petrol, no fumes, no exhausts and low noise – the silent motor provides a comfortable working environment and low disturbance for the surrounding areas.



MAXIMUM RUNTIME

Husqvarna battery handheld products feature savE™, a battery economy mode which you can choose when you want to maximise your operational time. Some models also feature 3 performance settings allowing you to match power performance to the job in hand.



PROTECTED CORE

Our batteries are all developed in-house and designed to withstand tough and frequent use. All sensitive components and cells are encapsulated and well protected against rain and dirt.



HIGH PERFORMANCE

Our brushless electric E-TORQ motors, developed in-house, deliver high, consistent torque from low revs – enough for the most demanding tasks. The E-TORQ motors are encapsulated and designed to be maintenance-free.



MADE TO FIT

Husqvarna's battery products and motors are developed directly together with the batteries. This means purpose-adapted application design that makes the machines both lighter and slimmer.





WHY CHOOSE BATTERY?

THE BENEFITS OF THE HUSQVARNA BATTERY SERIES



MAXIMUM FLEXIBILITY

Our battery system can be used on all Battery Series products making them extremely flexible. The batteries have features which prolong lifespan and allow them to be run and recharged continuously. Always ready to use.



HIGH PERFORMANCE

Powerful compact long-life Husqvarna developed motors with low weight offer instant and equal torque no matter what the operating speed. This results in performance which exceeds petrol equivalent machines. Our E-TORQ motors also offer 90% efficiency for maximum runtime.



SAVES YOU MONEY

Costing as little as 4p to recharge a battery, the machines have a much lower cost to operate compared to petrol equivalents. The benefits are even higher when used professionally or full time.



EASY TO USE

Low weight and excellent balance make the products extremely comfortable to handle. The machines are switched ON and OFF at the push of a button via the unique keypad making them effortless to start and also protected against accidental activation.



500 SERIES

PROFESSIONAL DURABILITY

Using our vast experience of what is required to meet the needs of professional use, all of our 500 series battery products are put through the same duration lab test procedures as our 500 Series 2-stroke petrol products.



HEALTHIER WORK

With no direct emissions our battery products are clean and pleasant to use. This is especially beneficial when working in confined spaces and allows safe use in covered and indoor areas.



LOW NOISE

Products are up to 18db(A) lower noise than petrol equivalents. A reduction of 3dB(A) is seen as half the noise level. This makes for a comfortable work environment and low disturbance for others, enabling the possibility to work in noise sensitive areas.



ALL WEATHER USE

Our 500 Series products are IPX4 rated and can be used in the most demanding weather conditions. The sealed motors, electronics and batteries protect against ingress of dirt and moisture allowing you to keep working.



COMFORTABLE USE

With less moving parts our products offer lower levels of vibration when compared to equivalent petrol machines. This allows the machines to be used for longer periods maximising work output whilst increasing comfort.



FLEET SERVICES

Husqvarna Fleet Services is fully compatible with the Husqvarna Battery Series. Fleet Services allows landscapers and contractors to take full control of their operations. Giving insights in to their daily business allowing a more profitable & efficient operation.

“Husqvarna's professional range of battery products have brought a new and refreshing aspect to a 34 year career in tree care for me. Apart from the physical and environmental benefits, Husqvarna's battery powered products have given me a faster, more efficient and far more enjoyable way of working.”

Tim Bendle, H-TEAM Ambassador





MAXIMUM FLEXIBILITY AND OPTIMUM PERFORMANCE

WHY WE USE 36V LI-ION

If we compare a 36V Li-ion (5.2Ah) battery versus a 72V Li-ion (2.6Ah) battery:

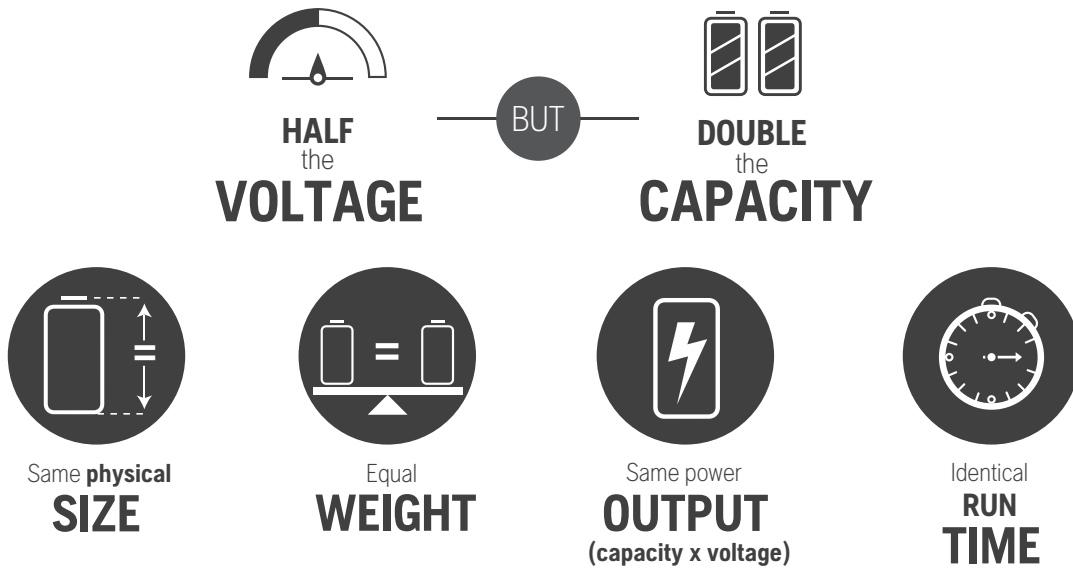

TO IMPROVE BATTERY PERFORMANCE IT REQUIRES:



| Number of cells a battery can be increased by | 10 (BLi100) | 20 (BLi200) | 30 (BLi300) | 40 |
|---|-------------|-------------|-------------|----|
| 36V BATTERY | ✓ | ✓ | ✓ | ✓ |
| 72V BATTERY | ✗ | ✓ | ✗ | ✓ |

OFFERS MAXIMUM FLEXIBILITY

FOR USE WITH HANDHELD MACHINES

- ✓ RANGE OF APPLICATIONS
- ✓ HIGH PERFORMANCE
- ✓ COMPACT SIZE
- ✓ LOW WEIGHT

Battery capacity used for illustrative purpose only



PRODUCT USE GUIDE





WORKING TIME ON ONE CHARGE

The working time available with a fully charged battery depends on three variables: the capacity of the battery, which machine the battery is used with and the type of work you are doing. The chart shows an estimate of the operating time you can expect from your Husqvarna battery equipment in different work situations.



| APPLICATION | PRODUCT NAME | BATTERY | | | | | | |
|--------------------------|--------------|--------------------|-------------|------------|------------|------------|------------|------------|
| | | BLi950X | BLi550X | BLi300 | BLi200X | BLi200 | BLi100 | |
| CHAINSAWS | | | | | | | | |
| Pruning | | 540i XP® | 7 h 30 min | 3 h 45 min | 2 h 15 min | 1 h 15 min | 1 h 15 min | 40 min |
| | | 535i XP® | 7 h 30 min | 3 h 45 min | 2 h 15 min | 1 h 15 min | 1 h 15 min | 40 min |
| Pruning (Arborists only) | | T540i XP® | 17 h 30 min | 9 h | 5 h 30 min | 3 h | 3 h | 1 h 30 min |
| | | T535i XP® | 17 h 30 min | 9 h | 5 h 30 min | 3 h | 3 h | 1 h 30 min |
| Carpentry | | 540i XP® | 18 h 45 min | 9 h 40 min | 5 h 40 min | 3 h | 3 h | 1 h 30 min |
| | | 535i XP® | 18 h 45 min | 9 h 40 min | 5 h 40 min | 3 h | 3 h | 1 h 30 min |
| Log cutting | | 540i XP® | 3 h 30 min | 1 h 45 min | 1 h | 30 min | 30 min | 15 min |
| | | 535i XP® | 3 h 30 min | 1 h 45 min | 1 h | 30 min | 30 min | 15 min |
| POLE SAWS | | | | | | | | |
| Pruning | | 530iPT5 | 11 h 30 min | 5 h 45 min | 3 h 30 min | 2 h | 2 h | 50 min |
| | | 530iP4 | | | | | | |
| BRUSHCUTTERS | | | | | | | | |
| Clearing | | 535iFR - Saw blade | 3 h 20 min | 1 h 35 min | 1 h | 30 min | 30 min | — |
| Tough grass cutting | | 535iRXT - Blade | 2 h 25 min | 1 h 5 min | 45 min | 25 min | 25 min | — |
| | | 535iRX - Blade | | | | | | |
| | | 535iFR - Blade | | | | | | |
| Tough grass cutting | | 535iRXT - Line | 1 h 50 min | 50 min | 30 min | 15 min | 15 min | — |
| | | 535iRX - Line | | | | | | |
| | | 535iFR - Line | | | | | | |
| TRIMMERS | | | | | | | | |
| Tough grass cutting | | 520iRX | 4 h 15 min | 2 h | 1 h 15 min | 40 min | 40 min | 20 min |
| | | 520iLX | | | | | | |
| Light grass trimming | | 520iRX | 8 h 15 min | 4 h 15 min | 2 h 15 min | 1 h 20 min | 1 h 20 min | 40 min |
| | | 520iLX | | | | | | |
| HEDGE TRIMMERS | | | | | | | | |
| Tough cutting | | 520iHT4 | 6 h | 3 h | 1 h 45 min | 1 h | 1 h | 30 min |
| | | 520iHE3 | | | | | | |
| | | 520iHD70 | | | | | | |
| | | 520iHD60 | | | | | | |
| Light trimming | | 520iHT4 | 12 h 30 min | 6 h 15 min | 3 h 45 min | 2 h | 2 h | 1 h |
| | | 520iHE3 | | | | | | |
| | | 520iHD70 | | | | | | |
| | | 520iHD60 | | | | | | |
| BLOWERS | | | | | | | | |
| Tough blowing | | 550iBTX | 1 h | 30 min | — | — | — | — |
| | | 530iBX* | 1 h 45 min | 45 min | 35 min | 15 min | 15 min | 10 min |
| | | 525iB | | | | | | |
| Light blowing | | 550iBTX | 1 h 45 min | 50 m | — | — | — | — |
| | | 530iBX* | 3 h 30 min | 1 h 45 min | 1 h | 35 min | 35 min | 15 min |
| | | 525iB | | | | | | |



| APPLICATION | PRODUCT NAME | BATTERY | | | | | |
|---------------------------------------|---|-------------------|------------|------------|---------|---------|--------|
| | | BLi950X | BLi550X | BLi300 | BLi200X | BLi200 | BLi100 |
| POWER CUTTER | | | | | | | |
| Cutting - 40 mm concrete paving slabs |  K 535i | | | 40 pcs | 20 pcs | 20 pcs | |
| Cutting - Roof tiles |  K 535i | — | — | 165 pcs | 85 pcs | 85 pcs | — |
| Cutting - 7 mm floor tiles |  K 535i | | | 240 pcs | 140 pcs | 140 pcs | |
| LAWN MOWERS | | | | | | | |
| Mowing |  | LC 551iV** | 1 h 35 min | 50 min | 30 min | | 15 min |
| | | LB 548i** | 2 h 20 min | 1 h 15 min | 45 min | | 25 min |
| | | LB 448i | — | — | 45 min | | 25 min |
| | | LB 442i | — | — | 55 min | | 35 min |

The runtimes are up-to times and correspond to work time using saveE™: actual work, basic maintenance and movement / climbing needed for generic operations. Given guidelines are indicative only and may not always be repeatable from one setting to another.
 *Requires backpack battery / battery belt FLEXI. **Requires bracket and adapter for use with backpack batteries *** Run time refers to the use of 2 BLi batteries
 Recommended battery — Battery does not fit machine shown

CHARGING TIME FOR BATTERIES AND CHARGERS

| TYPE OF USE | BATTERY | CHARGING CYCLES | QC500 | | QC330 | | QC250 | | C80 | | QC80F | |
|---|---|-----------------|----------------|------------|----------------|------------|----------------|------------|----------------|------------|----------------|------------|
| | | | CHARGING LEVEL | | CHARGING LEVEL | | CHARGING LEVEL | | CHARGING LEVEL | | CHARGING LEVEL | |
| | | | 80% | 100% | 80% | 100% | 80% | 100% | 80% | 100% | 80% | 100% |
| PART-TIME FULL-TIME PROFESSIONAL USE |  BLi100 | 1500 | 30 min | 50 min | 30 min | 50 min | 1 h 5 min | 1 h 25 min | 1 h 5 min | 1 h 25 min | 1 h 5 min | 1 h 25 min |
| |  BLi200 / X | 1500 | 30 min | 50 min | 30 min | 50 min | 2 h 25 min | 2 h 40 min | 2 h 25 min | 2 h 40 min | 2 h 25 min | 2 h 40 min |
| |  BLi300 | 1500 | 35 min | 1 h | 55 min | 1 h 20 min | 4 h | 4 h 20 min | 4 h | 4 h 20 min | 4 h | 4 h 20 min |
| |  BLi550X | 1500 | 1 h | 1 h 25 min | 1 h 40 min | 2 h 5 min | — | — | — | — | — | — |
| |  BLi950X | 1500 | 1 h 40 min | 2 h 55 min | 3 h | 4 h 5 min | — | — | — | — | — | — |

— Battery does not fit charger shown.  Recommended solution.

WHAT A TEAM COULD SAVE IN 2 YEARS

Petrol is expensive. Electricity less so. So when you invest in battery-powered equipment, it doesn't take long before you get your money back. In the long run, you can actually save a lot of money by switching to battery power. This example is based on a landscaping team of three people working for two years with a typical range of comparable equipment.

- EQUIPMENT***
2 handheld blowers, 3 trimmers/brushcutters, 2 hedge trimmers, 1 pole hedge trimmer with comparable capacity and performance
- INTEGRATED BATTERIES**
2 × BLi100, 5 × BLi200 and 3 × BLi300
- BACKPACK BATTERIES**
1 × BLi950X
- CHARGERS**
4 × QC500
- REFUELLING/RECHARGING***

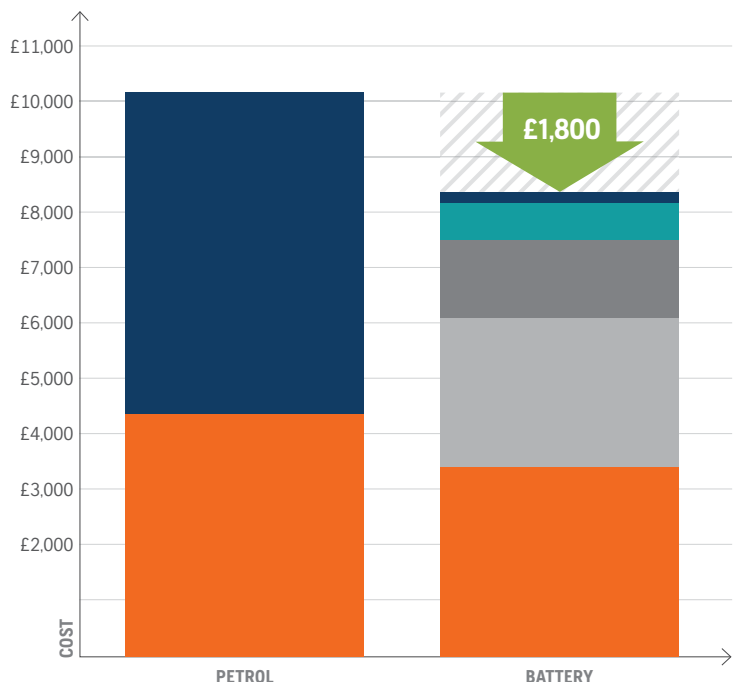

*The comparisons are based on daily and typical, professional use, with seasons ranging from 50 to 150 days. Fuel costs are based on alkylate petrol (£2.30 / L) or electricity (£0.10 / kWh). Other costs, such as service and repairs, are not included.



CHAINSaws



High performance battery chainsaws, pole saws and power cutter designed for professional use. The products feature compact high torque motors giving constant levels of torque no matter what the cutting speed. All models offer petrol performance with lower noise, running costs and no direct emissions.

Ideal for applications including:

- **Arboriculture**
- **Forestry**
- **Landscape maintenance**
- **Parks and public spaces**
- **Noise sensitive areas**
- **Building and light construction (535 / 540i XP® / K 535i)**
- **Hard landscaping (K 535i)**

T 540i XP®



High performance battery powered arborist chainsaw offering 40 cm³ equivalent performance and chain speed. Weatherproof (IPX4) and low noise, ideal for use in noise sensitive areas.

- X-CUT™ SP21G Chain
- Low noise
- Secondary eyelet
- LED keypad with savE™
- 40 cm³ petrol performance
- Captive bar nut

535i XP®

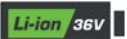

Professional battery powered chainsaw offering petrol performance with maximum ease of use. Low noise, ideal for use in noise sensitive areas.

- X-CUT™ SP21G chain
- Low noise
- Captive bar nut
- Keypad with savE™
- 20 m/s chain speed
- Weatherproof (IPX4)

| Voltage | Motor type | Vibration levels F/R | Weight |
|-------------------------------------|----------------|----------------------------|-----------------------|
| 36V Li-ion | BLDC Brushless | 2.5 / 2.8 m/s ² | 26 kg (excl. battery) |
| Model | Order PNC | RRP ex VAT | RRP inc VAT |
| Unit only - 35 cm / 14" | 967 89 38-14 | £332.50 | £399.00 |
| Unit + BLi200 & QC330 (recommended) | | £598.33 | £717.99 |

540i XP®

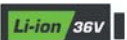

High performance professional battery powered chainsaw with high chain speed and maximum ease of use. Low noise, ideal for use in noise sensitive areas.

- X-CUT™ SP21G chain
- Low noise
- 40cm³ petrol performance
- LED keypad with savE™
- Slim body
- Weatherproof (IPX4)

| Voltage | Motor type | Vibration levels F/R | Weight |
|---|----------------|----------------------------|-----------------------|
| 36V Li-ion | BLDC Brushless | 3.6 / 3.7 m/s ² | 29 kg (excl. battery) |
| Model | Order PNC | RRP ex VAT | RRP inc VAT |
| Unit only - 35 cm / 14" | 967 86 40-14 | £499.17 | £599.00 |
| Unit only - 40 cm / 16" | 967 86 40-16 | £507.50 | £609.00 |
| Unit 16" + BLi300 & QC330 (recommended) | | £839.99 | £1,007.99 |



Li-ion 36V



Secondary eyelet allows quick connection to a tool carrier on the climbing harness improving climbing efficiency.



Intuitive keypad with easily accessible ON / OFF button which makes stopping and starting between cuts safe and effortless.

| Voltage | Motor Type | Vibration Levels F/R | Weight |
|--|----------------|---------------------------|-----------------------|
| 36V Li-ion | BLDC Brushless | 21 / 3.4 m/s ² | 25 kg (excl. battery) |
| Model | Order PNC | RRP Ex VAT | RRP Inc VAT |
| Unit only 30 cm / 12" | 967 86 37-12 | £490.83 | £589.00 |
| Unit only - 35 cm / 14" | 967 86 37-14 | £499.17 | £599.00 |
| Unit 12" + BLi200X and QC330 (recommended) | | £764.99 | £917.99 |

T535i XP®

Li-ion 36V



Battery powered arborist chainsaw offering petrol equivalent chainspeed. Low noise level and weatherproof (IPX4) make it ideal in noise sensitive areas.

- X-CUT™ SP21G chain
- Low noise
- 20 m/s chain speed
- Keypad with savE™
- Secondary eyelet
- Weatherproof (IPX4)

| Voltage | Motor type | Vibration levels F/R | Weight |
|-------------------------------------|----------------|----------------------------|------------------------|
| 36V Li-ion | BLDC Brushless | 2.0 / 2.4 m/s ² | 2.4 kg (excl. battery) |
| Model | Order PNC | RRP ex VAT | RRP inc VAT |
| Unit Only - 30 cm / 12" | 967 89 39-12 | £332.50 | £399.00 |
| Unit + BLi200 & QC330 (recommended) | | £598.33 | £717.99 |

K 535i

Li-ion 36V



Battery power cutter designed for lighter concrete jobs, ideal for landscapers, pavers and roofers. Weatherproof (IPX4)

- 230 mm / 9" blade diameter
- Cutting depth 76 mm / 3"
- Electric retarder
- Keypad with savE™
- Integrated dust suppression
- Rope eyelet

| Voltage | Power output | Vibration levels F/R | Weight |
|-------------------------------------|----------------|---------------------------|-----------------------|
| 36V Li-ion | BLDC Brushless | 21 / 2.5 m/s ² | 35 kg (excl. battery) |
| Model | Order PNC | RRP ex VAT | RRP inc VAT |
| K 535i unit only | 967 79 59-01 | £453.00 | £543.60 |
| Unit + BLi200 & QC330 (recommended) | | £718.83 | £862.59 |
| Tacti-Cut S35s 230mm | 596 52 03-01 | £51.00 | £61.20 |

BATTERIES



Powerful 36V Li-ion batteries designed for professional use. Maximum capacity for longer run times. Choose BLi backpack batteries for maximum run time.

- Ideal for 500 series
- All weather use
- 4 LED charge indicator
- Battery management system
- Up to 1500 charges
- Active cooling
- Integrated & backpack options
- Continuous use (charge / re-charge)

| Model | Order PNC | RRP ex VAT | RRP inc VAT |
|-----------------------|--------------|------------|------------------|
| BLi100 2.6Ah | 967 09 18-01 | £124.17 | £149.00 |
| BLi200 5.2Ah | 967 09 19-01 | £182.50 | £219.00 |
| BLi200X 5.2Ah | 970 44 89-01 | £190.83 | £229.00 |
| BLi300 9.4Ah | 967 07 19-01 | £249.17 | £299.00 |
| BLi550X 15.6Ah B/pack | 967 09 31-01 | £624.17 | £749.00 |
| BLi950X 31.1Ah B/pack | 967 09 32-01 | £999.17 | £1,199.00 |

CHARGERS



Chargers designed for professional use. QC500 is optimised for BLi300 and backpack batteries.

- 100 - 240V
- Active cooling
- LED status indicator

| Model | Order PNC | RRP ex VAT | RRP inc VAT |
|--------------|--------------|------------|----------------|
| QC330 - 330W | 967 09 14-02 | £83.33 | £99.99 |
| QC500 - 500W | 967 09 15-02 | £116.66 | £139.99 |

For the full range of battery accessories please see pages 28 – 31

HUSQVARNA RECOMMEND

Technical Extreme PPE for professional performance. Pages 170 - 171





TRIMMERS & BRUSHCUTTERS



High performance battery grass trimmers, brush cutters and clearing saw designed for professional use. The products feature compact high torque motors giving constant levels of torque no matter what the cutting speed. This makes them ideal for a range of applications.

All models offer petrol performance with lower noise, running costs and no direct emissions.

Ideal for applications including:

- **Landscape maintenance**
- **Parks and public spaces**
- **Noise sensitive areas**

535iRXT



High-performance battery bull horn brushcutter designed for professional use in medium applications. 35 cm³ petrol equivalent performance.

- Fleet Services™ ready
- ErgoFeed™ auto line feed
- Integrated or backpack batteries
- ErgoFeed™ head and grass blade
- Low Vib®
- Magnesium chassis
- Weatherproof (IPX4)
- Balance XB™ Harness

520iLX



Professional use battery loop handle trimmer with 2-way rotation trimmer head.

- Brushless motor
- Two way head rotation
- Blade capable
- Keypad with savE™
- T25B Tap'n Go head
- Weatherproof (IPX4)

| Voltage | Motor type | Vibration levels F/R | Weight |
|------------------------------------|----------------|----------------------------|-----------------------|
| 36V Li-ion | BLDC Brushless | 1.2 / 0.7 m/s ² | 30 kg (excl. battery) |
| Model | Order PNC | RRP ex VAT | RRP inc VAT |
| 520iLX Unit only | 967 91 61-11 | £274.17 | £329.00 |
| Unit + BLi200 & Q330 (recommended) | | £539.99 | £647.99 |
| J-Handle Kit | 587 37 50-01 | £20.83 | £24.99 |

520iRX



Professional use battery bullhorn trimmer with 2-way rotation trimmer head. Supplied with grass blade.

- Brushless motor
- Two way head rotation
- T25B head & grass blade
- Keypad with savE™
- Balance 35B harness
- Weatherproof (IPX4)

| Voltage | Motor type | Vibration levels F/R | Weight |
|-------------------------------------|----------------|----------------------------|------------------------|
| 36V Li-ion | BLDC Brushless | 1.2 / 0.7 m/s ² | 3.8 kg (excl. battery) |
| Model | Order PNC | RRP ex VAT | RRP inc VAT |
| 520iRX Unit only | 967 91 62-02 | £290.83 | £349.00 |
| Unit + BLi200 & QC330 (recommended) | | £556.66 | £667.99 |



Li-ion 36V



Intuitive key pad is equipped with power button, LED battery status indicator as well as 3 speed mode for the E-TORQ™ motor. ErgoFeed™ button is positioned close to the thumb for convenience.



ErgoFeed™ function feeds trimmer line with a simple push of a button. Reducing risk of unintentional feed, minimising trimmer line consumption. Trimmer head is designed with minimum moving parts for robust and durability.

| Voltage | Motor Type | Vibration Levels F/R | Weight |
|-------------------------------------|----------------|----------------------------|------------------------|
| 36V Li-ion | BLDC Brushless | 1.2 / 1.4 m/s ² | 4.9 kg (excl. battery) |
| Model | Order PNC | RRP Ex VAT | RRP Inc VAT |
| 535iRX Unit only | 967 85 06-01 | £499.17 | £599.00 |
| Unit + BLi300 & QC500 (recommended) | | £864.99 | £1,037.99 |

535iRX

Li-ion 36V



High-performance battery bull horn brushcutter designed for professional use in medium applications. 35 cm³ petrol equivalent performance.

- Low Vib®
- Balance 55 harness
- Weatherproof (IPX4)
- Intuitive keypad
- 45cm cutting swath

| Voltage | Motor type | Vibration levels F/R | Weight |
|-------------------------------------|----------------|----------------------------|------------------------|
| 36V Li-ion | BLDC Brushless | 1.3 / 1.4 m/s ² | 4.9 kg (excl. battery) |
| Model | Order PNC | RRP ex VAT | RRP inc VAT |
| 535iRX Unit only | 967 85 06-03 | £432.50 | £519.00 |
| Unit + BLi300 & QC500 (recommended) | | £798.33 | £957.99 |

535iFR

Li-ion 36V



High-performance battery clearing saw designed for lighter forestry clearing applications. 35 cm³ petrol equivalent performance.

- Fleet Services™ ready
- Saw & grass blades
- 45cm cutting swath
- Intuitive keypad
- Balance 55 harness
- Weatherproof (IPX4)

| Voltage | Motor type | Vibration levels F/R | Weight |
|-------------------------------------|----------------|----------------------------|------------------------|
| 36V Li-ion | BLDC Brushless | 1.4 / 1.7 m/s ² | 4.5 kg (excl. battery) |
| Model | Order PNC | RRP ex VAT | RRP inc VAT |
| 535iFR Unit only | 967 85 05-01 | £457.50 | £549.00 |
| Unit + BLi300 & QC500 (recommended) | | £823.33 | £987.99 |

BATTERIES



Powerful 36V Li-ion batteries designed for professional use. Maximum capacity for longer run times. Choose BLi backpack batteries for maximum run time.

- Ideal for 500 series
- All weather use
- 4 LED charge indicator
- Battery management system
- Up to 1500 charges
- Active cooling
- Integrated & backpack options
- Continuous use (charge / re-charge)

| Model | Order PNC | RRP ex VAT | RRP inc VAT |
|-----------------------|--------------|------------|------------------|
| BLi100 2.6Ah | 967 09 18-01 | £124.17 | £149.00 |
| BLi200 5.2Ah | 967 09 19-01 | £182.50 | £219.00 |
| BLi200X 5.2Ah | 970 44 89-01 | £190.83 | £229.00 |
| BLi300 9.4Ah | 967 07 19-01 | £249.17 | £299.00 |
| BLi550X 15.6Ah B/pack | 967 09 31-01 | £624.17 | £749.00 |
| BLi950X 31.1Ah B/pack | 967 09 32-01 | £999.17 | £1,199.00 |

CHARGERS



Chargers designed for professional use. QC500 is optimised for BLi300 and backpack batteries.

- 100 - 240V
- Active cooling
- LED status indicator

| Model | Order PNC | RRP ex VAT | RRP inc VAT |
|--------------|--------------|------------|----------------|
| QC330 - 330W | 967 09 14-02 | £83.33 | £99.99 |
| QC500 - 500W | 967 09 15-02 | £116.66 | £139.99 |

For the full range of battery accessories please see pages 28 – 31

HUSQVARNA RECOMMEND

Technical Brushcutter and Trimmer clothing. Page 172





HEDGE TRIMMERS & POLE SAWS



High performance battery hedge trimmers and pole saws designed for professional use. The products feature compact high torque motors giving constant levels of torque no matter what the cutting speed. This makes them ideal for a range of applications.

All models offer petrol performance with lower noise, running costs and no direct emissions.

Ideal for applications including:

- **Landscape maintenance**
- **Parks and public spaces**
- **Noise sensitive areas**

520iHD60



Very quiet but highly efficient professional battery hedge trimmer with excellent ergonomics. Weatherproof (IPX4) with low noise and vibrations.

- High torque motor
- Adjustable rear handle
- 4000 cuts/min blade speed
- Keypad with savE™
- Dual sided blade
- Weatherproof (IPX4)

| Voltage | Motor type | Vibration levels F/R | Weight |
|-------------------------------------|-------------------|----------------------------|------------------------|
| 36V Li-ion | High torque motor | 1.6 / 2.5 m/s ² | 3.8 kg (excl. battery) |
| Model | Order PNC | RRP ex VAT | RRP inc VAT |
| Unit Only - 60 cm | 967 91 56-02 | £374.17 | £449.00 |
| Unit + BLi200 & QC330 (recommended) | | £639.99 | £767.99 |

520iHD70



Very quiet but highly efficient professional battery hedge trimmer with excellent ergonomics. Weatherproof (IPX4) with low noise and vibrations.

- High torque motor
- Adjustable rear handle
- 4000 cuts/min blade speed
- Keypad with savE™
- Dual sided blade
- Weatherproof (IPX4)

| Voltage | Motor type | Vibration levels F/R | Weight |
|-------------------------------------|-------------------|----------------------------|------------------------|
| 36V Li-ion | High torque motor | 2.3 / 3.5 m/s ² | 3.9 kg (excl. battery) |
| Model | Order PNC | RRP ex VAT | RRP inc VAT |
| Unit Only - 70 cm | 967 91 57-02 | £415.83 | £499.00 |
| Unit + BLi200 & QC330 (recommended) | | £681.66 | £817.99 |

520iHE3



Highly efficient professional battery pole hedge trimmer with 3.5m reach, features adjustable cutter bar. Weatherproof (IPX4) with low noise and vibrations.

- Brushless motor
- Remote cutter adjustment
- 4000 cuts/min blade speed
- Keypad with savE™
- Transport position
- Head adjustment 120°

| Voltage | Motor type | Vibration levels F/R | Weight |
|-------------------------------------|----------------|----------------------------|-----------------------|
| 36V Li-ion | BLDC Brushless | 3.5 / 2.5 m/s ² | 41 kg (excl. battery) |
| Model | Order PNC | RRP ex VAT | RRP inc VAT |
| Unit only - 55 cm | 967 91 58-11 | £332.50 | £399.00 |
| Unit + BLi200 & QC330 (recommended) | | £598.33 | £717.99 |



520iHT4

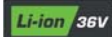

Telescopic professional battery pole hedge trimmer with 4.5m reach, features adjustable cutter bar. Weatherproof (IPX4) with low noise and vibrations.

- Brushless motor
- Extended length 3.5 m
- 4000 cuts/min blade speed
- Keypad with savE™
- Transport position
- Head adjustment 120°

| Voltage | Motor type | Vibration levels F/R | Weight |
|-------------------------------------|----------------|----------------------------|------------------------|
| 36V Li-ion | BLDC Brushless | 2.0 / 1.7 m/s ² | 5.3 kg (excl. battery) |
| Model | Order PNC | RRP ex VAT | RRP inc VAT |
| Unit only - 55 cm | 967 97 12-01 | £415.83 | £499.00 |
| Unit + BLi200 & QC330 (recommended) | | £681.66 | £817.99 |

530iP4



Robust fixed length battery pole saw designed for professional use. Lightweight and well balanced with petrol equivalent performance. Weatherproof (IPX4).

- 20 m/s chain speed
- Fixed length
- Low noise
- Keypad with savE™
- 250 cm length
- Slimline cutting head

| Voltage | Motor type | Vibration levels F/R | Weight |
|-------------------------------------|----------------|----------------------------|------------------------|
| 36V Li-ion | BLDC Brushless | 1.0 / 0.9 m/s ² | 3.4 kg (excl. battery) |
| Model | Order PNC | RRP ex VAT | RRP inc VAT |
| Unit only - 25 cm / 10" | 967 88 47-10 | £374.17 | £449.00 |
| Unit + BLi200 & QC330 (recommended) | | £639.99 | £767.99 |

530iPT5

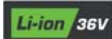

Robust telescopic pole saw designed for professional use. Lightweight and well balanced with petrol equivalent performance. Weatherproof (IPX4).

- 20 m/s chain speed
- Telescopic
- Low noise
- Keypad with savE™
- 293 - 400 cm length
- Slimline cutting head

| Voltage | Motor type | Vibration levels F/R | Weight |
|-------------------------------------|----------------|----------------------------|------------------------|
| 36V Li-ion | BLDC Brushless | 1.0 / 1.2 m/s ² | 5.0 kg (excl. battery) |
| Model | Order PNC | RRP ex VAT | RRP inc VAT |
| Unit only - 25 cm / 10" | 967 88 48-10 | £457.50 | £549.00 |
| Unit + BLi200 & QC330 (recommended) | | £723.33 | £867.99 |

BATTERIES



Powerful 36V Li-ion batteries designed for professional use. Maximum capacity for longer run times. Choose BLi backpack batteries for maximum run time.

- Ideal for 500 series
- All weather use
- 4 LED charge indicator
- Battery management system
- Up to 1500 charges
- Active cooling
- Integrated & backpack options
- Continuous use (charge / re-charge)

| Model | Order PNC | RRP ex VAT | RRP inc VAT |
|-----------------------|--------------|------------|------------------|
| BLi100 2.6Ah | 967 09 18-01 | £124.17 | £149.00 |
| BLi200 5.2Ah | 967 09 19-01 | £182.50 | £219.00 |
| BLi200X 5.2Ah | 970 44 89-01 | £190.83 | £229.00 |
| BLi300 9.4Ah | 967 07 19-01 | £249.17 | £299.00 |
| BLi550X 15.6Ah B/pack | 967 09 31-01 | £624.17 | £749.00 |
| BLi950X 31.1Ah B/pack | 967 09 32-01 | £999.17 | £1,199.00 |

CHARGERS



Chargers designed for professional use. QC500 is optimised for BLi300 and backpack batteries.

- 100 - 240V
- Active cooling
- LED status indicator

| Model | Order PNC | RRP ex VAT | RRP inc VAT |
|--------------|--------------|------------|----------------|
| QC330 - 330W | 967 09 14-02 | £83.33 | £99.99 |
| QC500 - 500W | 967 09 15-02 | £116.66 | £139.99 |

For the full range of battery accessories please see pages 28 – 31

HUSQVARNA RECOMMEND

Husqvarna protective glasses. Page 178





BLOWERS



High performance battery handheld blowers designed for full-time professional use. With unique fan design and brushless motors, the products produce petrol equivalent performance and powerful airflow. The blowers are ideal for use in noise sensitive or enclosed spaces.

Ideal for applications including:

- Landscape maintenance
- Parks and public spaces
- Inner city cleaning
- Noise sensitive areas
- Indoor and enclosed spaces

525iB

Li-ion 36V



Low weight, handheld battery blower designed for professional use. Weatherproof (IPX4) and low noise, ideal for use in noise sensitive areas.

- 13.3 m³/min, 56 m/s
- Brushless motor
- Cruise control & Boost
- In-line air outlet
- Keypad with savE™
- Weatherproof (IPX4)

| Voltage | Motor type | Vibration levels | Weight |
|-------------------------------------|----------------|----------------------|------------------------|
| 36V Li-ion | BLDC Brushless | 0.5 m/s ² | 2.4 kg (excl. battery) |
| Model | Order PNC | RRP ex VAT | RRP inc VAT |
| 525iB Unit only | 967 91 55-02 | £ 315.83 | £379.00 |
| Unit + BLi200 & QC330 (recommended) | | £581.66 | £697.99 |

530iBX

Li-ion 36V



High performance ultra low noise battery blower designed for professional use. Backpack battery only and weatherproof (IPX4) for maximum performance.

- 14.1 m³/min, 56.2 m/s
- Brushless motor
- Cruise control & Boost
- 77.6dB(A) noise level
- Keypad with savE™
- Backpack battery use only

| Voltage | Motor type | Vibration levels | Weight |
|--------------------------------------|----------------|----------------------|------------------------|
| 36V Li-ion | BLDC Brushless | 0.4 m/s ² | 2.9 kg (excl. battery) |
| Model | Order PNC | RRP ex VAT | RRP inc VAT |
| 530iBX Unit only | 967 94 14-02 | £ 357.50 | £429.00 |
| Unit + BLi950X & QC500 (recommended) | | £1,473.33 | £1,767.99 |

550iBTX

Li-ion 36V



Powerful and ergonomic backpack battery blower for professional use. Extremely low noise and vibration levels and weatherproof (IPX4) giving maximum flexibility and productivity.

- 12.8 m³/min, 54.6 m/s
- Brushless motor
- Cruise control & Boost
- 76.6dB(A) noise level
- Keypad with savE™
- Backpack battery use only

| Voltage | Motor type | Vibration levels | Weight |
|--------------------------------------|----------------|----------------------|-----------------------|
| 36V Li-ion | BLDC Brushless | 0.1 m/s ² | 6.3kg (excl. battery) |
| Model | Order PNC | RRP ex VAT | RRP inc VAT |
| 550iBTX Unit only | 967 68 11-02 | £ 499.17 | £599.00 |
| Unit + BLi950X & QC500 (recommended) | | £1,614.99 | £1,937.99 |



BALANCE 35



Ergonomically designed harness that distributes the load optimally between your shoulders, chest and back. Designed for use with smaller brush cutters.

| Order PNC | RRP ex VAT | RRP inc VAT |
|--------------|------------|---------------|
| 537 27 57-02 | £45.83 | £54.99 |

HANDLEBAR ATTACHMENT



Enables use of both hands for manoeuvring the blower improving ergonomics when using for prolonged periods.

| Fits to | Order PNC | RRP ex VAT | RRP inc VAT |
|-------------|--------------|------------|---------------|
| All blowers | 501 71 51-01 | £29.16 | £34.99 |

FLAT NOZZLE



Flat nozzle for more concentrated airflow spreading it wider and closer to the ground.

| Fits to | Order PNC | RRP ex VAT | RRP inc VAT |
|-------------|--------------|------------|--------------|
| All blowers | 579 79 75-01 | £8.33 | £9.99 |

BATTERIES



Powerful 36V Li-ion batteries designed for professional use. Maximum capacity for longer run times. Choose BLi backpack batteries for maximum run time.

- Ideal for 500 series
- All weather use
- 4 LED charge indicator
- Battery management system
- Up to 1500 charges
- Active cooling
- Integrated & backpack options
- Continuous use (charge / re-charge)

| Model | Order PNC | RRP ex VAT | RRP inc VAT |
|-----------------------|--------------|------------|------------------|
| BLi100 2.6Ah | 967 09 18-01 | £124.17 | £149.00 |
| BLi200 5.2Ah | 967 09 19-01 | £182.50 | £219.00 |
| BLi200X 5.2Ah | 970 44 89-01 | £190.83 | £229.00 |
| BLi300 9.4Ah | 967 07 19-01 | £249.17 | £299.00 |
| BLi550X 15.6Ah B/pack | 967 09 31-01 | £624.17 | £749.00 |
| BLi950X 31.1Ah B/pack | 967 09 32-01 | £999.17 | £1,199.00 |

CHARGERS



Chargers designed for professional use. QC500 is optimised for BLi300 and backpack batteries.

- 100 - 240V
- Active cooling
- LED status indicator

| Model | Order PNC | RRP ex VAT | RRP inc VAT |
|--------------|--------------|------------|----------------|
| QC330 - 330W | 967 09 14-02 | £83.33 | £99.99 |
| QC500 - 500W | 967 09 15-02 | £116.66 | £139.99 |

For the full range of battery accessories please see pages 28 – 31

SHARE your stories and photos on your Facebook, Instagram and Twitter by tagging us.

HusqvarnaUK

UK_Husqvarna

HusqvarnaUK / HusqvarnaGardenUK



LAWN MOWERS



Collection and mulch battery lawn mowers designed for full-time professional use on medium and larger areas in the most demanding conditions. Featuring commercial grade components and a range of commercial batteries that deliver outstanding performance, durability and reliability no matter what the application. The machines are simple to use and very easy to maintain.

Ideal for applications including:

- Municipalities
- Landscape and grounds maintenance
- Parks and public spaces
- Noise sensitive areas
- Sports turf

LC 551iV



High performance fully professional self-propelled battery lawn mower designed for full-time use. High performance cast aluminium deck giving excellent collection performance. Digital variable speed control, user interface and Fleet Services™ compatible.

- Collect / rear eject
- Adjustable, folding handles
- Integrated x2 or backpack battery
- 65 litre collector
- Cast aluminium deck / wheels
- Central height adjustment
- Vibration level 0.3 m/s²
- Weather proof (IPX4)

LB 442i

NEW SPRING



Compact battery mulch mower designed for semi-professional use, ideal in complex smaller areas. Features user interface with PowerBoost and save™ modes. Fleet Services™ compatible.

- BioClip® (mulch)
- Adjustable handle
- 2 integrated battery slots
- Cast aluminium deck
- Central height adjustment
- Vibration level 0.3 m/s²

| Voltage | Cutting Width | Cutting Height | Drive |
|-------------------------------------|---------------|----------------|----------------|
| 36V Li-ion | 42 cm | 34 - 55 mm | Push |
| Model | Order PNC | RRP ex VAT | RRP inc VAT |
| LB 442i Unit only | 970 48 23-01 | £457.50 | £549.00 |
| Unit + BLi300 & QC500 (recommended) | | £832.33 | £987.99 |

LB 448i

NEW SPRING



Battery mulch mower designed for semi-professional use, ideal in complex areas. Features user interface with PowerBoost and save™ modes. Fleet Services™ compatible.

- BioClip® (mulch)
- Adjustable handle
- 2 integrated battery slots
- Cast aluminium deck
- Central height adjustment
- Vibration level 0.3 m/s²

| Voltage | Cutting Width | Cutting Height | Drive |
|-------------------------------------|---------------|----------------|------------------|
| 36V Li-ion | 48 cm | 30 - 60 mm | Push |
| Model | Order PNC | RRP ex VAT | RRP inc VAT |
| LB 448i Unit only | 970 48 24-01 | £624.17 | £749.00 |
| Unit + BLi300 & QC500 (recommended) | | £989.99 | £1,187.99 |



Li-ion 36V



Intuitive keypad with SavE™ and status indicators. Control the ground speed of the mower at the push of a button to suit your walking speed.



Dual BLi integrated battery slots with automatic switch over for maximum convenience and run time. Backpack battery capable with BLi carrier accessory.

| Voltage | Cutting Width | Cutting Height | Drive |
|-------------------------------------|---------------|----------------|------------------|
| 36V Li-ion | 51 cm | 26 - 74 mm | Variable speed |
| Model | Order PNC | RRP Ex VAT | RRP Inc VAT |
| LC 55iV Unit only | 967 97 72-01 | £1,040.83 | £1,249.00 |
| Unit + BLi300 & QC500 (recommended) | | £1,406.66 | £1,687.99 |

LB 548i

Li-ion 36V



High capacity mulch mower designed for professional use, ideal in complex areas. Features user interface with PowerBoost and savE™ modes. Fleet Services™ compatible.

- BioClip® (mulch)
- Adjustable handle
- Integrated x2 or backpack battery
- Cast aluminium deck / wheels
- Central height adjustment
- Vibration level 0.3 m/s²

| Voltage | Cutting Width | Cutting Height | Drive |
|-------------------------------------|---------------|----------------|------------------|
| 36V Li-ion | 48 cm | 30 - 60 mm | Push |
| Model | Order PNC | RRP ex VAT | RRP inc VAT |
| LB 548i Unit only | 967 97 73-01 | £790.83 | £949.00 |
| Unit + BLi300 & QC500 (recommended) | | £1,156.66 | £1,387.99 |

BATTERIES



Powerful 36V Li-ion batteries designed for professional use. Maximum capacity for longer run times. Choose BLi backpack batteries for maximum run time.

- Ideal for 500 series
- All weather use
- 4 LED charge indicator
- Battery management system
- Up to 1500 charges
- Active cooling
- Integrated & backpack options
- Continuous use (charge / re-charge)

| Model | Order PNC | RRP ex VAT | RRP inc VAT |
|------------------------|--------------|------------|------------------|
| BLi100 2.6Ah | 967 09 18-01 | £124.17 | £149.00 |
| BLi200 5.2Ah | 967 09 19-01 | £182.50 | £219.00 |
| BLi200X 5.2Ah | 970 44 89-01 | £190.83 | £229.00 |
| BLi300 9.4Ah | 967 07 19-01 | £249.17 | £299.00 |
| BLi550X 15.6Ah Battery | 579 82 44-01 | £582.50 | £699.00 |
| BLi950X 31.1Ah Battery | 579 82 22-01 | £957.50 | £1,149.00 |

CHARGERS



Chargers designed for professional use. QC500 is optimised for BLi300 and backpack batteries.

- 100 - 240V
- Active cooling
- LED status indicator

| Model | Order PNC | RRP ex VAT | RRP inc VAT |
|--------------|--------------|------------|----------------|
| QC330 - 330W | 967 09 14-02 | £83.33 | £99.99 |
| QC500 - 500W | 967 09 15-02 | £116.66 | £139.99 |

For the full range of battery accessories please see pages 28 – 31

DID YOU KNOW?

The BLi carrier attachment allows the BLi backpack batteries to power the mowers for extended runtime.



| Model | Order PNC | RRP ex VAT | RRP inc VAT |
|----------------------|--------------|------------|---------------|
| BLi Backpack Carrier | 597 84 87-01 | £37.49 | £44.99 |



MAXIMUM FLEXIBILITY

OPTIMISED BATTERY SOLUTIONS

BATTERIES

Interchangeable Li-ion batteries with a capacity of 94, 187 or 338 Wh.



BACKPACK BATTERIES

Comfortable, heavy-duty backpacks with enough battery capacity for up to a full day's work. Choose between 562 or 1120 Wh.



BATTERY BELT FLEXI

Comfortable belt with room for up to three batteries as well as additional accessories. Available in three different versions.





CHARGERS

Quickly charge integrated batteries as well as backpack batteries with our chargers with active battery cooling.

THREE WAYS TO CONNECT. YOU CHOOSE.



Combination optimised for maximum agility.

1 MACHINE + BATTERY



Combination optimised for low weight.

2 MACHINE + BATTERY + BATTERY BELT FLEXI WITH ADAPTER KIT



ADAPTER

The adapter allows you to connect a backpack or battery belt FLEXI with connector kit to a handheld machine, to lighten the load on your arms and shoulders and to have more runtime.



Combination optimised for longest working time.

3 MACHINE + BACKPACK BATTERY + ADAPTER



ACCESSORIES

Our range of storage boxes, carrying bags and other accessories make your battery-powered workday even more convenient and productive.





ACCESSORIES



BLi100 BATTERY



Powerful integrated batteries designed for professional use. High power to weight ratio with maximum capacity for longer run times.

- Ideal for 500 series
- 4 LED charge indicator
- Up to 1500 charges
- Continuous use
- All weather use
- Battery management system
- Active cooling

| Type | Capacity | Energy | Weight |
|------------|--------------|------------|----------------|
| 36V Li-ion | 2.6 Ah | 94 Wh | 0.9 kg |
| Model | Order PNC | RRP ex VAT | RRP inc VAT |
| BLi100 | 967 09 18-01 | £124.17 | £149.00 |

BLi200 BATTERY



Powerful integrated batteries designed for professional use. High power to weight ratio with maximum capacity for longer run times.

- Ideal for 500 series
- 4 LED charge indicator
- Up to 1500 charges
- Continuous use
- All weather use
- Battery management system
- Active cooling

| Type | Capacity | Energy | Weight |
|------------|--------------|------------|----------------|
| 36V Li-ion | 5.2 Ah | 187 Wh | 1.3 kg |
| Model | Order PNC | RRP ex VAT | RRP inc VAT |
| BLi200 | 967 09 19-01 | £182.50 | £219.00 |

BLi200X BATTERY

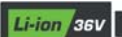

Powerful integrated battery designed specifically for use with the 540 / T540i XP® chainsaws. High power to weight ratio with maximum capacity for longer run times.

- For use with T540 / 540i XP®
- 4 LED charge indicator
- Up to 1500 charges
- Continuous use
- All weather use
- Battery management system
- Active cooling

| Type | Capacity | Energy | Weight |
|------------|--------------|------------|----------------|
| 36V Li-ion | 5.2 Ah | 187 Wh | 1.3 kg |
| Model | Order PNC | RRP ex VAT | RRP inc VAT |
| BLi200X | 970 44 89-01 | £190.83 | £229.00 |

BLi300 BATTERY



Our largest capacity integrated battery designed for intensive professional use. Market leading capacity, ideal for high energy use applications.

- Ideal for 500 series
- 4 LED charge indicator
- Up to 1500 charges
- Continuous use
- All weather use
- Battery management system
- Active cooling

| Type | Capacity | Energy | Weight |
|------------|--------------|------------|----------------|
| 36V Li-ion | 9.4 Ah | 338 Wh | 1.8 kg |
| Model | Order PNC | RRP ex VAT | RRP inc VAT |
| BLi300 | 967 07 19-01 | £249.17 | £299.00 |

BLi550X BACKPACK BATTERY



High performance backpack battery designed for intensive professional use. Ideal for low to medium energy use applications allowing up to a full days use on a single charge.

- Ideal for 500 series
- Percentage charge indicator
- Up to 1500 charges
- Continuous use
- IPX4 rated - All weather use
- Battery management system
- Active cooling
- Adjustable harness with cable routing

| Type | Capacity | Energy | Weight |
|------------------------|--------------|------------|----------------------|
| 36V Li-ion | 15.6 Ah | 562 Wh | 5.6 kg excl. harness |
| Model | Order PNC | RRP ex VAT | RRP inc VAT |
| BLi550X | 967 09 31-01 | £624.17 | £749.00 |
| BLi550X - Battery only | 579 82 44-01 | £582.50 | £699.00 |

BLi950X BACKPACK BATTERY



Large capacity high performance backpack battery designed for intensive professional use. Ideal for high energy use applications allowing up to a full days use on a single charge.

- Ideal for 500 series
- Percentage charge indicator
- Up to 1500 charges
- Continuous use
- IPX4 rated - All weather use
- Battery management system
- Active cooling
- Adjustable harness with cable routing

| Type | Capacity | Energy | Weight |
|------------------------|--------------|------------|----------------------|
| 36V Li-ion | 31.1 Ah | 1120 Wh | 6.9 kg excl. harness |
| Model | Order PNC | RRP ex VAT | RRP inc VAT |
| BLi950X | 967 09 32-01 | £999.17 | £1,199.00 |
| BLi950X - Battery only | 579 82 22-01 | £957.50 | £1,149.00 |

BATTERY BAG



Keeps batteries warm in winter and cool in summer. Effectively absorbs shocks. For BLi10 /20 /100 /200.

| Model | Order PNC | RRP ex VAT | RRP inc VAT |
|-------------|--------------|------------|---------------|
| Battery Bag | 585 37 18-01 | £23.33 | £27.99 |

BATTERY BOXES



Boxes for safe transport and storage of Husqvarna batteries, chargers and other accessories. Medium includes plastic inserts to hold 4 battery and charger or 6 batteries.

Small - 160x400x300mm
 Medium - 210x400x300mm With insert
 Large - 210x500x300mm

| Item | Order PNC | RRP ex VAT | RRP inc VAT |
|---------------------------------|--------------|------------|---------------|
| Small | 585 42 87-01 | £41.66 | £49.99 |
| NEW Medium - with insert | 597 16 85-01 | £49.17 | £59.00 |
| Large | 585 42 88-01 | £62.49 | £74.99 |



COMFORTABLE BATTERY SYSTEM BELT

Husqvarna Flexi battery belt allows you to carry your spare Husqvarna BLi batteries and accessories on your hips for added comfort during long, efficient workdays. By connecting your product to a battery in the belt, you can also reduce the carrying weight. Durable and comfortable design for tough work.



Robust design for carrying a number of batteries and accessories



Water-resistant material

Possible to add braces, available as option.

5 fixing points for batteries and application specific tools



Tool-less system for moving batteries and accessories

Universal carrying system for accessories

BATTERY BELT FLEXI - CARRYING KIT



For carrying up to 3 spare integrated BLi batteries as well as additional accessories. Ideal for when working remotely.

- 5 fixing points
- Carry up to 3 BLi batteries
- 2 BLi carriers included
- Accessory bag included

| Model | Order PNC | RRP ex VAT | RRP inc VAT |
|--------------------|--------------|------------|---------------|
| Flexi carrying kit | 590 77 67-01 | £74.99 | £89.99 |

BATTERY BELT FLEXI - ADAPTER KIT



Enables Husqvarna BLi integrated batteries to be connected to the product from the belt instead of in the product, reducing overall product weight.

- 5 fixing points
- Carry up to 3 BLi batteries
- 1 BLi carrier included
- 1 BLi carrier with adapter included
- Accessory bag included

| Model | Order PNC | RRP ex VAT | RRP inc VAT |
|-------------------|--------------|------------|----------------|
| Flexi adapter kit | 590 77 67-02 | £116.66 | £139.99 |

BATTERY BELT FLEXI - CONNECTOR KIT



Enables backpack battery only products to be powered using a BLi integrated battery whilst allowing additional batteries and accessories to be carried.

- 5 fixing points
- Carry up to 3 BLi batteries
- 1 BLi carrier included
- 1 BLi carrier with connector included
- Accessory bag included
- Connector for 536LiBX / 530iBX only

| Model | Order PNC | RRP ex VAT | RRP inc VAT |
|---------------------|--------------|------------|----------------|
| Flexi connector kit | 590 77 67-03 | £124.99 | £149.99 |

HARNESS FOR TOOL BELT FLEXI



Ergonomic design together with a chest strap evens the weight over the shoulders.

| Model | Order PNC | RRP ex VAT | RRP inc VAT |
|---------|--------------|------------|---------------|
| Harness | 593 83 76-01 | £27.49 | £32.99 |

BACKPACK ADAPTER



Enables battery belt Flexi - connector kit to be used with complete battery series handheld range (excludes 536LiBX / 530iBX).

| Model | Order PNC | RRP ex VAT | RRP inc VAT |
|-------------|--------------|------------|---------------|
| Adapter kit | 582 78 05-01 | £74.99 | £89.99 |

BLi CARRIER



BLi battery carrier for carrying additional batteries, clips on to Flexi battery belts. Maximum 3 BLi carriers per belt.

| Model | Order PNC | RRP ex VAT | RRP inc VAT |
|-------------|--------------|------------|---------------|
| BLi Carrier | 590 77 72-01 | £16.66 | £19.99 |

ACCESSORY BAG



Universal carrying system for accessories or refreshments.

| Model | Order PNC | RRP ex VAT | RRP inc VAT |
|---------------|--------------|------------|--------------|
| Accessory bag | 596 25 29-01 | £8.33 | £9.99 |



QC80F CHARGER



Field charger for charging from 12 V car/truck outlet during transport.

- Recommended use BLi10 - 300
- Voltage 12V
- Charge indicator LED

| Charging power | Order PNC | RRP ex VAT | RRP inc VAT |
|----------------|--------------|------------|---------------|
| 80W | 967 62 83-01 | £66.66 | £79.99 |

C80 CHARGER

NEW
SUMMER



Standard charger designed for domestic use.

- Recommended use BLi10 - 20
- Mains voltage 100 - 240V
- Charge indicator LED

| Charging power | Order PNC | RRP ex VAT | RRP inc VAT |
|----------------|--------------|------------|---------------|
| 80W | 970 48 78-02 | £33.33 | £39.99 |

QC250 CHARGER



Quick charger designed for occasional and part-time use. Features active cooling to prolong the life of the battery.

- Recommended use BLi10 - 30
- Mains voltage 100 - 240V
- Charge indicator LED
- Active cooling

| Charging power | Order PNC | RRP ex VAT | RRP inc VAT |
|----------------|--------------|------------|---------------|
| 250W | 967 97 01-02 | £58.33 | £69.99 |

QC330 CHARGER



Quick charger designed for professional use.

- Recommended use BLi10 - 200
- Mains voltage 100 - 240V
- Charge indicator LED
- Active cooling

| Charging power | Order PNC | RRP ex VAT | RRP inc VAT |
|----------------|--------------|------------|---------------|
| 330W | 967 09 14-02 | £83.33 | £99.99 |

QC500 CHARGER



High speed charger designed for efficient charging of high capacity batteries. Ideal for intensive professional applications.

- Recommended use BLi300 - 950X
- Mains voltage 100 - 240V
- Charge indicator LED
- Active cooling

| Charging power | Order PNC | RRP ex VAT | RRP inc VAT |
|----------------|--------------|------------|----------------|
| 500W | 967 09 15-02 | £116.66 | £139.99 |

V1600F VOLTAGE CONVERTOR



Enables quick charging in the field by converting 12V DC from any lead-acid battery to 220V AC.

- All QC Chargers
- Voltage 12V

| Charging power | Order PNC | RRP ex VAT | RRP inc VAT |
|----------------|--------------|------------|----------------|
| | 967 62 85-02 | £165.83 | £199.00 |

BACKPACK BATTERY HIP PAD



Fastens to the BLi backpack battery harness removing the need for two harnesses. Ideal with bullhorn brushcutter and blowers. Fits BLi520X - 950X

| Model | Order PNC | RRP ex VAT | RRP inc VAT |
|---------|--------------|------------|---------------|
| Hip pad | 587 83 40-01 | £19.16 | £22.99 |

Locate your nearest dealer
Visit: www.husqvarna.com/uk/dealer-locator





TECHNICAL SPECIFICATIONS



| BATTERY CHAINSAWS | 535i XP® | T535i XP® | 540i XP® | T540i XP® |
|--|------------------|------------------|------------------|------------------|
| TECHNICAL SPECIFICATIONS | | | | |
| Battery type | Li-Ion | Li-Ion | Li-Ion | Li-Ion |
| Voltage, V | 36 | 36 | 36 | 36 |
| Motor type | BLDC (brushless) | BLDC (brushless) | BLDC (brushless) | BLDC (brushless) |
| Chain speed max power m/s | 20 | 20 | 24 | 24 |
| Sound pressure level at operators ear, dB(A) | 93 | 93 | 95 | 92 |
| Sound power level guaranteed (LWA) dB(A) | 106 | 106 | 106 | 103 |
| Equivalent vibration level (ahv, eq) front/rear handle, m/s ² * | 2.5 / 2.8 | 2.0 / 2.4 | 3.6 / 3.7 | 2.1 / 3.4 |
| Chain pitch, inch | 0.325 / 1/4 | 0.325 / 1/4 | 0.325 | 0.325 |
| Recommended bar length, min-max, cm/inch | 25-35/10-14 | 25-35/10-14 | 30-35 / 12-14 | 30-35 / 12-14 |
| Weight (excl. battery and cutting equipment), kg | 2.6 | 2.4 | 2.9 | 2.5 |
| FEATURES | | | | |
| Belt eye let | — | ● | — | ● |
| Flip up tank cap | ● | ● | ● | ● |
| Inertia chain brake | ● | ● | ● | ● |
| Intuitive key pad | ● | ● | ● | ● |
| Retained bar nuts | ● | ● | ● | ● |
| savE™ | ● | ● | ● | ● |
| Tool-less chain tensioning | — | — | — | — |

● = Available (●) = Accessory — = Not available *Equivalent vibration level, according to EN 60745-2-13. Reported data for equivalent vibration level has a typical statistical dispersion (standard deviation) of 1 m/s². Declared vibration data from measurements when the machine is fitted with a bar length and recommended chain type. If the machine is fitted with a different bar length, the vibration level may vary by max ± 15 m/s².

| BATTERY POLE SAWS | 530iP4 | 530iPT5 | BATTERY POWER CUTTER | K 535i |
|--|------------------|------------------|---|----------------|
| TECHNICAL SPECIFICATIONS | | | TECHNICAL SPECIFICATIONS | |
| Battery type | Li-Ion | Li-Ion | Battery type | Li-Ion |
| Voltage, V | 36 | 36 | Battery voltage, V | 36 |
| Motor type | BLDC (brushless) | BLDC (brushless) | Motor type | BLDC Brushless |
| Chain speed max power m/s | 20 | 20 | Blade, mm | 230 |
| Sound pressure level at operators ear, dB(A) | 88 | 83 | Cutting depth, mm | 76 |
| Sound power level guaranteed (LWA) dB(A) | 98 | 98 | Sound pressure level at operators ear, dB(A) | 98,5 |
| Equivalent vibration level (ahv, eq) front/rear handle, m/s ² * | 1.0 / 0.9 | 1.0 / 1.2 | Sound power level guaranteed (LWA) dB(A) | 109,5 |
| Chain pitch, inch | 1/4 | 1/4 | Equivalent vibration level (ahv, eq) handle, m/s ² * 0 | 2.1/2.5 |
| Recommended bar length, min-max, cm/inch | 25-30/10-12 | 25-30/10-12 | Weight (excl. battery and cutting equipment), kg | 3,5 |
| Length, extended, with cutting equipment, cm | 250 | 400 | | |
| Weight (excl. battery and cutting equipment), kg | 3.4 | 5.0 | | |
| FEATURES | | | FEATURES | |
| Flip up tank cap | ● | ● | savE™ | ● |
| Harness eyelet | ● | ● | Electric retarder | ● |
| Intuitive key pad | ● | ● | Safety loop | ● |
| Rear impact guard | ● | ● | | |
| Retained bar nuts | — | — | | |
| savE™ | ● | ● | | |
| Telescopic tube | — | ● | | |
| HARNESS | | | | |
| Single harness | ● | ● | | |
| Flexible harness for backpack battery | — | — | | |

● = Available (●) = Accessory — = Not available *Equivalent vibration level, according to EN 60745-2-13. Reported data for equivalent vibration level has a typical statistical dispersion (standard deviation) of 1 m/s². Declared vibration data from measurements when the machine is fitted with a bar length and recommended chain type. If the machine is fitted with a different bar length, the vibration level may vary by max ± 15 m/s².



| BATTERY TRIMMERS | 520iLX | 520iRX | 535iRX | 535iRXT | 535iFR |
|---|------------------|------------------|------------------|------------------|------------------|
| TECHNICAL SPECIFICATIONS | | | | | |
| Battery type | Li-ion | Li-ion | Li-ion | Li-ion | Li-ion |
| Voltage, V | 36 | 36 | 36 | 36 | 36 |
| Motor type | BLDC (brushless) | BLDC (brushless) | BLDC (brushless) | BLDC (brushless) | BLDC (brushless) |
| Tube diameter, mm | 24 | 24 | 28 | 28 | 28 |
| Cutting diameter, cm | 40 | 40 | 45 | 45 | 45 |
| Sound pressure level at operators ear, dB(A) | 76 | 76 | 80 | 80 | 80 |
| Sound power level guaranteed (LWA) dB(A) | 96 | 96 | 96 | 96 | 96 |
| Equivalent vibration level (ahv, eq) left /right handle, m/s ² * | — | 1.2 / 0.7 | 1.3 / 1.4 | 1.2 / 1.4 | 1.4 / 1.7 |
| Equivalent vibration level (ahv, eq) front /rear handle, m/s ² * | 1.2 / 0.7 | — | — | — | — |
| Weight (excl. battery), kg | 3.0 | 3.8 | 4.9 | 4.9 | 4.5 |
| FEATURES | | | | | |
| High handlebar | — | ● | ● | ● | ● |
| Anti-vibration | — | — | ● | ● | — |
| Intuitive key pad | ● | ● | ● | ● | ● |
| savE™ | ● | ● | — | — | — |
| Tap-n-Go trimmer head | ● | ● | ● | — | ● |
| ErgoFeed™ trimmer head | — | — | — | ● | — |
| Two way rotation | ● | ● | — | — | — |
| 3-speed mode | — | — | ● | ● | ● |
| Click on attachments | — | — | — | — | — |
| HARNESS | | | | | |
| Balance 35B | — | ● | — | — | — |
| Balance 55 | — | — | ● | — | ● |
| Balance XB™ | — | — | — | ● | — |
| CUTTING EQUIPMENT | | | | | |
| | ● / (●) / — | ● / ● / — | ● / ● / — | ● / ● / — | ● / ● / ● |

● = Available (●) = Accessory — = Not available *Equivalent vibration level, according to EN 60745-2-13. Reported data for equivalent vibration level has a typical statistical dispersion (standard deviation) of 1 m/s².

| BATTERY HEDGE TRIMMERS | 520iHD60 | 520iHD70 | 520iHE3 | 520iHT4 |
|---|----------------|----------------|------------------|------------------|
| TECHNICAL SPECIFICATIONS | | | | |
| Battery type | Li-Ion | Li-Ion | Li-ion | Li-ion |
| Voltage, V | 36 | 36 | 36 | 36 |
| Motor type | PMDC (4-brush) | PMDC (4-brush) | BLDC (brushless) | BLDC (brushless) |
| Sound pressure level at operators ear dB(A) | 78 | 78 | 84 | 80 |
| Sound power level guaranteed (LWA), dB(A) | 94 | 94 | 95 | 94 |
| Equivalent vibration level (ahv, eq) front /rear handle, m/s ² * | 1.6 / 2.5 | 2.3 / 3.5 | 3.5 / 2.5 | 2.0 / 1.7 |
| Length cutting equipment, cm | 60 | 70 | 55 | 55 |
| Length, extended, with cutting equipment, cm | 117 | 127 | 226 | 350 |
| Teeth opening, mm | 32 | 32 | 32 | 32 |
| Cutting speed cuts /min | 4000 | 4000 | 4000 | 4000 |
| Weight (excl. battery), kg | 3.8 | 3.9 | 4.1 | 5.3 |
| FEATURES | | | | |
| Adjustable rear handle | ● | ● | — | — |
| Intuitive key pad | ● | ● | ● | ● |
| savE™ | ● | ● | ● | ● |
| Telescopic | — | — | — | ● |

● = Available (●) = Accessory — = Not available *Equivalent vibration level, according to EN 60745-2-13. Reported data for equivalent vibration level has a typical statistical dispersion (standard deviation) of 1 m/s².

A MINIMUM OF MAINTENANCE FOR MAXIMUM PERFORMANCE

Husqvarna battery-powered products need virtually no mechanical maintenance, however, sharp cutting equipment is always recommended and the electronics and software should be checked regularly to ensure problem-free operation. Let your battery product be serviced by qualified Husqvarna technicians using only Genuine Husqvarna or recommended spare parts. This will support the product's performance and lifetime. See your owner's manual or consult your Authorised Husqvarna dealer if any uncertainty occurs.



TECHNICAL SPECIFICATIONS



| BATTERY BLOWERS | 525iB | 530iBX | 550iBTX |
|---|------------------|-----------------------|-------------------|
| TECHNICAL SPECIFICATIONS | | | |
| Battery type | Li-Ion | Li-Ion | Li-Ion |
| Voltage, V | 36 | 36 | 36 |
| Motor type | BLDC (brushless) | BLDC (brushless) | BLDC (brushless) |
| Titled Blow Force | 14.5 | 16 | 21 |
| Sound pressure level at operators ear, dB(A) | 82 | 77.6 | 76.6 |
| Sound power level guaranteed (LWA), dB(A) | 98 | 91 | 94 |
| Equivalent vibration level (ahv, eq) handle, m/s ² * | 0.5 | 0.4 | 0.1 |
| Blow force boost, (N) | 14.5 | 16 | 21 |
| Air volume boost, m ³ /min | 13.3 | 14.1 | 15.6 |
| Air flow in pipe, m ³ /min | 11.6 | 12.4 | 12.8 |
| Air speed boost, m/s | 56 | 56.2 | 66 |
| Air speed, m/s | 48 | 49.6 | 54 |
| Weight (excl. battery), kg | 2.4 | 2.9 | 6.3 excl. battery |
| FEATURES | | | |
| Backpack battery | ● | ● | ● |
| Belt hook | ● | ● | — |
| Boost effect | ● | ● | ● |
| Cruise control | ● | ● | ● |
| Different tube lengths | (●) | (●) | (●) |
| Internal battery | ● | (●) Battery Belt Only | — |
| Intuitive key pad | ● | ● | ● |

● = Available (●) = Accessory — = Not available *Equivalent vibration level, according to EN 60745-2-13. Reported data for equivalent vibration level has a typical statistical dispersion (standard deviation) of 1 m/s².

| BATTERIES | BLi100 | BLi200 | BLi200X | BLi300 | BLi550X | BLi950X |
|------------------------------------|--------|--------|---------|--------|---------|---------|
| TECHNICAL SPECIFICATIONS | | | | | | |
| Battery type | Li-Ion | Li-Ion | Li-Ion | Li-Ion | Li-Ion | Li-Ion |
| Battery voltage, V | 36 | 36 | 36 | 36 | 36 | 36 |
| Capacity, Ah | 2.6 | 5.2 | 5.2 | 9.4 | 15.6 | 31.1 |
| Energy, Wh | 94 | 187 | 187 | 338 | 562 | 1120 |
| Weight, integrated, kg | 0.9 | 1.3 | 1.3 | 1.8 | — | — |
| Weight, backpack excl. harness, kg | — | — | — | — | 5.6 | 6.9 |
| Weight, backpack incl. harness, kg | — | — | — | — | 7.0 | 8.3 |
| State of charge indication | 4-Led | 4-Led | 4-Led | 4-Led | 5-Led | 5-Led |
| Charging cycles (up to) | 1500 | 1500 | 1500 | 1500 | 1500 | 1500 |

| CHARGERS | QC80F | C80 | QC250 | QC330 | QC500 |
|---------------------------------|-------|-----------|-----------|-----------|-----------|
| TECHNICAL SPECIFICATIONS | | | | | |
| Weight, kg | 0.6 | 0.6 | 0.7 | 1.4 | 1.4 |
| Charging power, W | 80 | 80 | 250 | 330 | 500 |
| Mains voltage, V | 12 | 100 - 240 | 100 - 240 | 100 - 240 | 100 - 240 |



| BATTERY LAWN MOWERS | LB 442i | LB 448i | LB 548i | LC 551iV |
|-----------------------------------|-----------|-----------|-----------|--------------------------------------|
| TECHNICAL SPECIFICATIONS | | | | |
| Battery type | Li-ion | Li-ion | Li-ion | Li-ion |
| Battery voltage, V | 36 | 36 | 36 | 36 |
| Drive system | Push | Push | Push | Self-propelled (variable) |
| Drive wheels | — | — | — | Rear |
| Rims, material | Aluminium | Aluminium | Aluminium | Aluminium |
| Wheel size, front/rear, mm | 180/180 | 208/208 | 208/208 | 210/210 |
| Speed, km/h | — | — | — | 3.0–5 |
| Cutting deck material | Aluminium | Aluminium | Aluminium | Aluminium |
| Cutting methods | BioClip® | BioClip® | BioClip® | Collection /Rear ejection / BioClip® |
| Cutting width, cm | 42 | 48 | 48 | 51 |
| Cutting height, min–max, mm | 34–55 | 30–60 | 30–60 | 26–74 |
| Cutting height steps | 4 | 6 | 6 | 6 |
| Collector type | — | — | — | Fabric with dust blocker |
| Collector volume, litres | — | — | — | 65 |
| Handle type | Ergonomic | Ergonomic | Ergonomic | Ergonomic |
| Weight, kg | 24.5 | 28.0 | 31.0 | 41.0 |
| FEATURES | | | | |
| Central cutting height adjustment | ● | ● | ● | ● |
| Double ball-bearing wheels | ● | ● | ● | ● |
| Foldable handle | — | — | — | ● |
| Handle height adjustment | ● | ● | ● | ● |
| savE™ | ● | ● | ● | ● |
| Double battery slots | ● | ● | ● | ● |
| PowerBoost | ● | ● | ● | ● |
| Husqvarna Connect enabled | ● | ● | ● | ● |
| BioClip kit as an accessory | — | — | — | ● |



PROFESSIONAL PERFORMANCE

Our product development never stops, and neither does our collaboration with the professional forestry workers who work with our machines. This is how we create chainsaws that help you work longer, producing less vibrations for less fatigue, and equipped with features that deliver high levels of safety. Every model gives you the power, performance and design excellence you expect from Husqvarna.



WHAT YOU GET AND HOW WE DO IT



EFFICIENCY AT ALL TIMES

User-centric design not only spares your body. It also enables you to stay alert and efficient. This is why our saws are packed with solutions that make your work convenient – and efficient.



RELIABLE CONSTRUCTION

For us, efficient chainsaw work is not synonymous with just power. A durable construction along with good safety is equally important when we design our saws, to keep you and the machine in good condition.



OPTIMAL PERFORMANCE

For fuel powered chainsaws, AutoTune™ automatically adjusts the engine for optimal operation based on temperature, fuel type, altitude, etc. The battery chainsaws all feature efficient motors with an impressive power-to-weight ratio.



RAW POWER

The patented X-Torq® engine technology in our petrol-powered chainsaws uses pure air instead of an air-fuel mixture to scavenge the exhaust fumes. This results in improved fuel efficiency and lower exhaust emissions compared to conventional 2-stroke engines.



LESS FILTER CLEANING

Air injection™ – is a centrifugal air cleaning system for reduced wear and longer operating time for our petrol-powered chainsaws. You will be able to work longer shifts without cleaning the air filter.











* Compared with equivalent models without this feature.



PRODUCT USE GUIDE









Use this guide to help you select the best product for your needs.

| TYPE OF USE | MODEL | POWER SOURCE | DISPLACEMENT / VOLTAGE | WEIGHT | SUPPLIED BAR LENGTH / S | | | |
|--|-----------------------|---|------------------------|--------------|-------------------------|---|---|--|
| | | | | | |  |  | |
| | | | | | | CARPENTRY | PRUNING | |
|  FULL-TIME USE (PROFESSIONAL) | 545 II | Petrol | 50.1 cm ³ | 5.3 kg | 37 cm / 15" | | | |
| | 555 | Petrol | 59.8 cm ³ | 5.9 kg | 45 cm / 18" | | | |
| | 565 | Petrol | 70.6 cm ³ | 6.5 kg | 45 - 50 cm / 18 - 20" | | | |
|  FULL-TIME USE (INTENSIVE PROFESSIONAL) | 535i XP® |  | 36V Li-ion | 2.6 kg* | 35 cm / 14" | ● | ● | |
| | 540i XP® |  | 36V Li-ion | 2.9 kg* | 35 - 40 cm / 14 - 16" | ● | ● | |
| | 550 XP® / G II | Petrol | 50.1 cm ³ | 5.3 / 5.4 kg | 33 - 45 cm / 13 - 18" | | | |
| | 560 XP® / G | Petrol | 59.8 cm ³ | 5.9 / 6.1 kg | 37 - 45 cm / 15 - 18" | | | |
| | 562 XP® / G | Petrol | 59.8 cm ³ | 6.1 / 6.3 kg | 45 cm / 18" | | | |
| | 572 XP® / G | Petrol | 70.6 cm ³ | 6.6 / 6.8 kg | 45 - 60 cm / 18 - 24" | | | |
|  FULL-TIME USE (QUALIFIED PERSONNEL ONLY) | T525 | Petrol | 27 cm ³ | 2.7 kg | 25 cm / 10" | | ● | |
| | T535i XP® |  | 36V Li-ion | 2.4 kg* | 30 cm / 12" | | ● | |
| | T540 XP® II | Petrol | 37.7 cm ³ | 3.9 kg | 30 - 35 cm / 12 - 14" | | ● | |
| | T540i XP® |  | 36V Li-ion | 2.5 kg* | 30 - 35 cm / 12 - 14" | | ● | |

The product selector is only to be used as a guide. Please visit your local Authorised Husqvarna dealer for more information.

* Excludes battery ● Optimised solution (guideline only) ○ Capable solution but not optimal (guideline only)



| |  |  |  |  |  |  |  |  | PAGE |
|--|---|---|---|---|---|--|---|---|---------|
| | FIREWOOD | SMALL TREES | LOGS | SMALL - MEDIUM TREES | MEDIUM TREES | MEDIUM - LARGE TREES | LARGE TREES | ARBORICULTURE | |
| | | ● | ● | ● | ● | | | | 40 |
| | | | ● | ● | ● | | | | 40 |
| | | | ● | ● | ● | ● | ○ | | 40 |
| | ● | ● | ○ | ○ | | | | | 42 |
| | ● | ● | ● | ● | | | | | 42 |
| | | ● | ● | ● | ● | | | | 43 |
| | | ○ | ● | ● | ● | ○ | | | 44 |
| | | ○ | ● | ● | ● | ○ | | | 44 / 45 |
| | | | ● | ○ | ● | ● | ● | | 45 |
| | | | | | | | | ● | 46 |
| | | | | | | | | ● | 46 |
| | | | | | | | | ● | 47 |
| | | | | | | | | ● | 47 |



CHAINSaws



Powerful chainsaws for frequent professional use. All saws feature magnesium crankcases and a 3 piece forged crankshaft for maximum durability. The 500 series models are packed with the latest technology optimising performance and productivity.

Ideal for applications including:

- Forestry
- Logging
- Horticulture
- Agriculture

545 II



New latest generation powerful, compact and fuel efficient chainsaw ideal for contractors and landscapers working with small to medium diameter timber.

- X-Torq®
- Low Vib®
- Smart Start®
- Air Injection™
- Autotune™ II
- Combined choke / stop control

| Displacement | Power output | Vibration levels F/R | Weight |
|----------------------|-----------------|----------------------------|----------------|
| 50.1 cm ³ | 2.7kW / 3.65 hp | 3.7 / 3.6 m/s ² | 5.3 kg |
| Bar length | Order PNC | RRP ex VAT | RRP inc VAT |
| 37 cm / 15" | 967 69 06-15 | £565.83 | £679.00 |

555



Powerful and fuel efficient chainsaw ideal for contractors and landscapers working with medium diameter timber.

- X-Torq®
- Low Vib®
- Smart Start®
- Air Injection™
- Autotune™
- Combined choke / stop control

| Displacement | Power output | Vibration levels F/R | Weight |
|----------------------|----------------|----------------------------|----------------|
| 59.8 cm ³ | 3.1kW / 4.2 hp | 3.2 / 5.0 m/s ² | 5.9 kg |
| Bar length | Order PNC | RRP ex VAT | RRP inc VAT |
| 45 cm / 18" | 970 50 12-18 | £707.50 | £849.00 |

565



Latest generation chainsaw, combining excellent ergonomics, durability, reliability with high power output, ideally suited for logging applications.

- X-Torq®
- Low Vib®
- Smart Start®
- Air Injection™
- Autotune™ II
- Combined choke / stop control

| Displacement | Power output | Vibration levels F/R | Weight |
|----------------------|----------------|----------------------------|----------------|
| 70.6 cm ³ | 3.7kW / 5.0 hp | 5.2 / 5.3 m/s ² | 6.5 kg |
| Bar length | Order PNC | RRP ex VAT | RRP inc VAT |
| 45 cm / 18" | 966 73 39-18 | £790.83 | £949.00 |
| 50 cm / 20" | 966 73 39-20 | £799.17 | £959.00 |



REPLACEMENT CUTTING EQUIPMENT

| Model | 545 | 555 |
|------------------|----------------|---------------|
| Bar | 37 cm / 15" | 45 cm / 18" |
| PNC | 582 08 69-64 | 582 08 69-72 |
| Ex VAT | £42.91 | £51.66 |
| Inc VAT | £51.49 | £61.99 |
| Chain | 37 cm / 15" | 45 cm / 18" |
| PNC | 501 84 04-64 | 501 84 04-72 |
| Ex VAT | £17.91 | £20.49 |
| Inc VAT | £21.49 | £24.49 |
| Technical | | |
| Drive Links | 64 | 72 |
| Pitch | 0.325" | |
| Gauge | 1.5 mm / 0.58" | |
| Type | H25 | |
| Cutter | Semi chisel | |
| File Size | 4.8 mm / 3/16" | |
| File Kit | | |
| PNC | 505 69 81-25 | |
| Ex VAT | £16.66 | |
| Inc VAT | £19.99 | |

| Model | 565 | |
|------------------|-------------------|---------------|
| Bar | 45 cm / 18" | 50 cm / 20" |
| PNC | 585 95 08-68 | 585 95 08-72 |
| Ex VAT | £51.66 | £57.49 |
| Inc VAT | £61.99 | £68.99 |
| Chain | 45 cm / 18" | 50 cm / 20" |
| PNC | 581 62 66-68 | 581 62 66-72 |
| Ex VAT | £24.16 | £25.41 |
| INC VAT | £28.99 | £30.49 |
| Technical | | |
| Drive Links | 68 | 72 |
| Pitch | 3/8" | |
| Gauge | 1.5 mm / 0.58" | |
| Type | X-CUT™ C85 | |
| Cutter | Chisel | |
| File Size | 5.5 mm / 7/32" | |
| File Kit | | |
| PNC | 586 93 85-01 | |
| Ex VAT | £16.66 | |
| Inc VAT | £19.99 | |

HUSQVARNA RECOMMEND

Technical Robust Trousers. Page 169





CHAINSaws



Our most technically advanced range of chainsaws designed for full-time intensive use in the most demanding conditions. The XP® range are developed solely to maximise your performance offering excellent power to weight ratio, class leading ergonomics and innovative solutions which optimise performance without compromise.

Ideal for applications including:

- Professional forestry
- Logging
- Arboriculture

535i XP®



Professional battery powered chainsaw offering petrol performance with maximum ease of use. Low noise, ideal for use in noise sensitive areas.

- X-CUT™ SP21G chain
- Low noise
- Captive bar nut
- Keypad with savE™
- 20 m/s chain speed
- Weatherproof (IPX4)

| Voltage | Motor type | Vibration levels F/R | Weight |
|-------------------------------------|----------------|----------------------------|-----------------------|
| 36V Li-ion | BLDC Brushless | 2.5 / 2.8 m/s ² | 26 kg (excl. battery) |
| Model | Order PNC | RRP ex VAT | RRP inc VAT |
| Unit only - 35 cm / 14" | 967 89 38-14 | £332.50 | £399.00 |
| Unit + BLi200 & QC330 (recommended) | | £598.33 | £717.99 |

540i XP®



High performance professional battery powered chainsaw with high chain speed and maximum ease of use. Low noise, ideal for use in noise sensitive areas.

- X-CUT™ SP21G chain
- Low noise
- 40cm³ petrol performance
- LED keypad with savE™
- Slim body
- Weatherproof (IPX4)

| Voltage | Motor type | Vibration levels F/R | Weight |
|---|----------------|----------------------------|-----------------------|
| 36V Li-ion | BLDC Brushless | 3.6 / 3.7 m/s ² | 29 kg (excl. battery) |
| Model | Order PNC | RRP ex VAT | RRP inc VAT |
| Unit only - 35 cm / 14" | 967 86 40-14 | £499.17 | £599.00 |
| Unit only - 40 cm / 16" | 967 86 40-16 | £507.50 | £609.00 |
| Unit 16" + BLi300 & QC330 (recommended) | | £839.99 | £1,007.99 |

| WORKING TIME ON ONE CHARGE | 535i XP® | | 540i XP® | |
|----------------------------|----------|---------|----------|---------|
| | PRUNING | LOG CUT | PRUNING | LOG CUT |



| | | | | | |
|--|--------------------|------------|--------|------------|--------|
| | BLi200 / X* | 1 h 15 min | 30 min | 1 h 15 min | 30 min |
| | BLi300 | 2 h 15 min | 1 h | 2 h 15 min | 1 h |

*BLi200X or BLi300 should be used with 540i XP®



550 XP® II



New latest generation high performance compact XP saw offering excellent ergonomics, ideal for forestry and arb applications.

- X-Torq®
- Air Injection™
- Low Vib®
- Autotune™ II

| Displacement | Power output | Vibration levels F/R | Weight |
|---------------------|----------------|----------------------------|----------------|
| 501 cm ³ | 3.0kW / 4.1 hp | 4.4 / 4.1 m/s ² | 5.3 kg |
| Bar length | Order PNC | RRP ex VAT | RRP inc VAT |
| 33 cm / 13" | 967 69 08-13 | £615.83 | £739.00 |
| 37 cm / 15" | 967 69 08-15 | £624.17 | £749.00 |
| 45 cm / 18" | 967 69 08-18 | £632.50 | £759.00 |

550 XP® G II



New latest generation high performance compact XP saw offering excellent ergonomics, ideal for forestry and arb applications.

- X-Torq®
- Air Injection™
- Low Vib®
- Autotune™ II
- Heated Handles

| Displacement | Power output | Vibration levels F/R | Weight |
|---------------------|----------------|----------------------------|----------------|
| 501 cm ³ | 3.0kW / 4.1 hp | 4.4 / 4.1 m/s ² | 5.5 kg |
| Bar length | Order PNC | RRP ex VAT | RRP inc VAT |
| 33 cm / 13" | 967 69 09-13 | £657.50 | £789.00 |
| 37 cm / 15" | 967 69 09-15 | £665.83 | £799.00 |
| 45 cm / 18" | 967 69 09-18 | £674.17 | £809.00 |

REPLACEMENT CUTTING EQUIPMENT

| Model | 535i XP® / 540i XP® | | |
|---------|---------------------|---------------|---------------|
| Bar | 30 cm / 12" | 35 cm / 14" | 40 cm / 16" |
| PNC | 593 91 43-51 | 593 91 43-59 | 593 91 43-64 |
| Ex VAT | £25.83 | £29.99 | £36.66 |
| Inc VAT | £30.99 | £35.99 | £43.99 |

| | | | |
|---------|---------------|---------------|---------------|
| Chain | 30 cm / 12" | 35 cm / 14" | 40 cm / 16" |
| PNC | 593 91 41-51 | 593 91 41-59 | 593 91 41-64 |
| Ex VAT | £20.42 | £23.33 | £25.41 |
| Inc VAT | £24.49 | £27.99 | £30.49 |

| Technical | | | |
|-------------|---------------------|----|----|
| Drive Links | 51 | 59 | 64 |
| Pitch | 0.325" Mini | | |
| Gauge | 1.1 mm / .043" | | |
| Type | X-CUT™ SP21G | | |
| Cutter | Semi chisel Mini | | |
| File Size | 4.0 mm / 5/32" | | |

| File Kit | |
|----------|---------------|
| PNC | 595 00 46-01 |
| Ex VAT | £16.66 |
| Inc VAT | £19.99 |

| Model | 550 XP® / XP® G | | |
|---------|-----------------|---------------|---------------|
| Bar | 33 cm / 13" | 37 cm / 15" | 45 cm / 18" |
| PNC | 582 08 69-56 | 582 08 69-64 | 582 08 69-72 |
| Ex VAT | £37.08 | £42.91 | £51.66 |
| Inc VAT | £44.49 | £51.49 | £61.99 |

| | | | |
|---------|---------------|---------------|---------------|
| Chain | 33 cm / 13" | 37 cm / 15" | 45 cm / 18" |
| PNC | 501 84 04-56 | 501 84 04-64 | 501 84 04-72 |
| Ex VAT | £15.83 | £17.91 | £20.41 |
| Inc VAT | £18.99 | £21.49 | £24.49 |

| Technical | | | |
|-------------|----------------|----|----|
| Drive Links | 56 | 64 | 72 |
| Pitch | 0.325" | | |
| Gauge | 1.5 mm / 0.58" | | |
| Type | H25 | | |
| Cutter | Semi chisel | | |
| File Size | 4.8 mm / 3/16" | | |

| File Kit | |
|----------|---------------|
| PNC | 505 69 81-25 |
| Ex VAT | £16.66 |
| Inc VAT | £19.99 |

HUSQVARNA RECOMMEND

XP® Power 2 Fuel



There is no better fuel for your Husqvarna product than our alkylate fuel manufactured to unique Husqvarna specifications. XP® Power 2 is mixed with exactly 2% of our XP® 2-stroke oil giving you a cleaner, cooler and healthier engine. Read more on pages 180 - 181.



CHAINSaws



Our most technically advanced range of chainsaws designed for full-time intensive use in the most demanding conditions. The XP® range are developed solely to maximise your performance offering excellent power to weight ratio, class leading ergonomics and innovative solutions which optimise performance without compromise.

Ideal for applications including:

- Professional forestry
- Logging
- Arboriculture

560 XP®



Advanced high performance mid range XP saw offering excellent ergonomics and a number of innovative features for maximising output. Ideal for forestry applications.

- X-Torq®
- Low Vib®
- RevBoost™
- Air Injection™
- Autotune™
- Smart Start®

| Displacement | Power output | Vibration levels F/R | Weight |
|----------------------|----------------|----------------------------|----------------|
| 59.8 cm ³ | 3.5kW / 4.8 hp | 4.4 / 5.3 m/s ² | 5.9 kg |
| Bar length | Order PNC | RRP ex VAT | RRP inc VAT |
| 37 cm / 15" | 970 50 17-15 | £707.50 | £849.00 |
| 45 cm / 18" | 970 50 17-18 | £715.83 | £859.00 |

560 XP® G



Advanced high performance mid range XP saw offering excellent ergonomics and a number of innovative features for maximising output. Ideal for forestry applications.

- X-Torq®
- Low Vib®
- RevBoost™
- Air Injection™
- Autotune™
- Heated Handles

| Displacement | Power output | Vibration levels F/R | Weight |
|----------------------|----------------|----------------------------|----------------|
| 59.8 cm ³ | 3.5kW / 4.8 hp | 4.4 / 5.3 m/s ² | 6.1 kg |
| Bar length | Order PNC | RRP ex VAT | RRP inc VAT |
| 37 cm / 15" | 970 50 19-15 | £749.17 | £899.00 |
| 45 cm / 18" | 970 50 19-18 | £757.50 | £909.00 |

562 XP®



Advanced high performance mid range XP saw offering excellent ergonomics, features high capacity air filter and 3/8" large barge mount. Ideal for forestry & arb applications.

- X-Torq®
- Low Vib®
- 3/8" large bar mount
- Air Injection™
- Autotune™

| Displacement | Power output | Vibration levels F/R | Weight |
|----------------------|----------------|----------------------------|----------------|
| 59.8 cm ³ | 3.5kW / 4.8 hp | 3.2 / 5.0 m/s ² | 6.1 kg |
| Bar length | Order PNC | RRP ex VAT | RRP inc VAT |
| 45 cm / 18" | 970 50 20-18 | £749.17 | £899.00 |



562 XP® G



Advanced high performance mid range XP saw offering excellent ergonomics, features high capacity air filter and 3/8" large barge mount. Ideal for forestry & arb applications.

- X-Torq®
- Low Vib®
- 3/8" large bar mount
- Air Injection™
- Autotune™
- Heated Handles

| Displacement | Power output | Vibration levels F/R | Weight |
|----------------------|----------------|----------------------------|----------------|
| 59.8 cm ³ | 3.5kW / 4.8 hp | 3.2 / 5.0 m/s ² | 6.3 kg |
| Bar length | Order PNC | RRP ex VAT | RRP inc VAT |
| 45 cm / 18" | 970 50 22-18 | £790.83 | £949.00 |

572 XP®



Latest generation chainsaw, combining excellent ergonomics, durability, reliability with high power output, ideally suited for professional forestry and Arboriculture.

- X-Torq®
- Low Vib®
- Soft cut out system
- Air Injection™
- Autotune™ II

| Displacement | Power output | Vibration levels F/R | Weight |
|----------------------|-----------------|----------------------------|------------------|
| 70.6 cm ³ | 4.3kW / 5.85 hp | 5.0 / 4.1 m/s ² | 6.6 kg |
| Bar length | Order PNC | RRP ex VAT | RRP inc VAT |
| 45 cm / 18" | 966 73 31-18 | £907.50 | £1,089.00 |
| 50 cm / 20" | 966 73 31-20 | £915.83 | £1,099.00 |
| 60 cm / 24" | 966 73 31-44 | £940.83 | £1,129.00 |
| 71 cm / 28" | 966 73 31-48 | 957.5 | 1149 |

572 XP® G



Latest generation chainsaw, combining excellent ergonomics, durability, reliability with high power output, ideally suited for professional forestry and Arboriculture.

- X-Torq®
- Low Vib®
- Soft cut out system
- Air Injection™
- Autotune™ II
- Heated Handles

| Displacement | Power output | Vibration levels F/R | Weight |
|----------------------|-----------------|----------------------------|------------------|
| 70.6 cm ³ | 4.3kW / 5.85 hp | 5.0 / 4.1 m/s ² | 6.8 kg |
| Bar length | Order PNC | RRP ex VAT | RRP inc VAT |
| 45 cm / 18" | 966 73 34-18 | £949.17 | £1,139.00 |
| 50 cm / 20" | 966 73 34-20 | £957.50 | £1,149.00 |
| 60 cm / 24" | 966 73 34-44 | £974.17 | £1,169.00 |

REPLACEMENT CUTTING EQUIPMENT

| Model | 560 XP® / XP® G | | |
|------------------|-----------------|---------------|---------------|
| Bar | 33 cm / 13" | 37 cm / 15" | 45 cm / 18" |
| PNC | 582 08 69-56 | 582 08 69-64 | 582 08 69-72 |
| Ex VAT | £370.8 | £42.91 | £51.66 |
| Inc VAT | £44.49 | £51.49 | £61.99 |
| Chain | 33 cm / 13" | 37 cm / 15" | 45 cm / 18" |
| PNC | 501 84 04-56 | 501 84 04-64 | 501 84 04-72 |
| Ex VAT | £15.83 | £17.91 | £20.41 |
| Inc VAT | £18.99 | £21.49 | £24.49 |
| Technical | | | |
| Drive Links | 56 | 64 | 72 |
| Pitch | 0.325" | | |
| Gauge | 1.5 mm / 0.58" | | |
| Type | H25 | | |
| Cutter | Semi chisel | | |
| File Size | 4.8 mm / 3/16" | | |
| File Kit | | | |
| PNC | 505 69 81-25 | | |
| Ex VAT | £16.66 | | |
| Inc VAT | £19.99 | | |

| Model | 562 / 572 XP® / XP® G | | |
|------------------|-----------------------|---------------|-----------------|
| Bar | 45 cm / 18" | 50 cm / 20" | 60 cm / 24" RSN |
| PNC | 585 95 08-68 | 585 95 08-72 | 596 69 11-84 |
| Ex VAT | £51.66 | £57.49 | £86.66 |
| Inc VAT | £61.99 | £68.99 | £103.99 |
| Chain | 45 cm / 18" | 50 cm / 20" | 60 cm / 24" |
| PNC | 581 62 66-68 | 581 62 66-72 | 581 62 66-84 |
| Ex VAT | £24.16 | £25.41 | £29.58 |
| Inc VAT | £28.99 | £30.49 | £35.49 |
| Technical | | | |
| Drive Links | 68 | 72 | 84 |
| Pitch | 3/8" | | |
| Gauge | 1.5 mm / 0.58" | | |
| Type | X-CUT™ C85 | | |
| Cutter | Chisel | | |
| File Size | 5.5 mm / 7/32" | | |
| File Kit | | | |
| PNC | 586 93 85-01 | | |
| Ex VAT | £16.66 | | |
| Inc VAT | £19.99 | | |

HUSQVARNA RECOMMEND

XP® Power 2 Fuel



There is no better fuel for your Husqvarna product than our alkylate fuel manufactured to unique Husqvarna specifications. XP® Power 2 is mixed with exactly 2% of our XP® 2-stroke oil giving you a cleaner, cooler and healthier engine. Read more on pages 180 - 181.



ARBORIST CHAINSaws

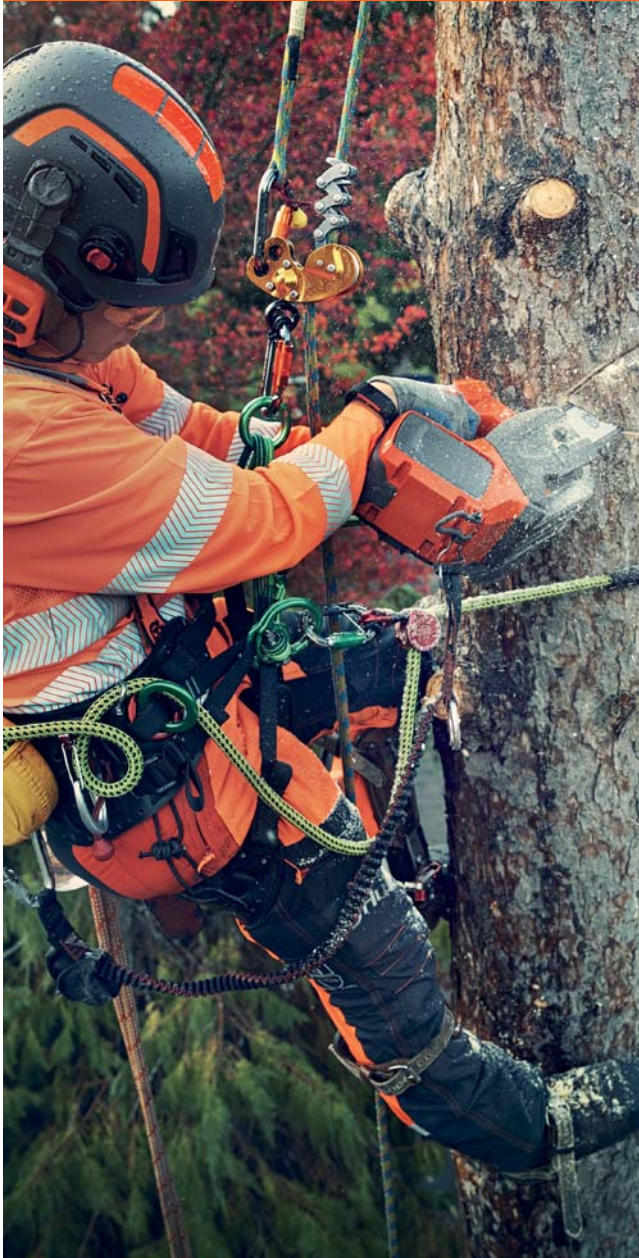

Specialist arborist chainsaws designed for professional use only. The XP® range are developed solely to maximise your performance offering excellent power to weight ratio, class leading ergonomics and innovative solutions which optimise performance without compromise.

Ideal for applications including:

- **Arboriculture**
- **Utilities maintenance**

T525



Powerful, low weight and compact petrol arborist chainsaw ideal for lighter arboriculture tasks including pruning.

- X-Torc®
- Low Vib®
- Flip-up filler cap
- Air Injection™
- Secondary eyelet
- 1/4" carving bar

| Displacement | Power output | Vibration levels F/R | Weight |
|--------------------|----------------|----------------------------|----------------|
| 27 cm ³ | 1.1kW / 1.5 hp | 4.9 / 5.2 m/s ² | 2.7 kg |
| Bar length | Order PNC | RRP ex VAT | RRP inc VAT |
| 25cm / 10" | 967 63 33-11 | £415.83 | £499.00 |

T535i XP®



Battery powered arborist chainsaw offering petrol equivalent chainspeed. Low noise level and weatherproof (IPX4) make it ideal in noise sensitive areas.

- X-CUT™ SP21G chain
- Low noise
- 20 m/s chain speed
- Keypad with savE™
- Secondary eyelet
- Weatherproof (IPX4)

| Voltage | Motor type | Vibration levels F/R | Weight |
|-------------------------------------|----------------|----------------------------|------------------------|
| 36V Li-ion | BLDC Brushless | 2.0 / 2.4 m/s ² | 2.4 kg (excl. battery) |
| Model | Order PNC | RRP ex VAT | RRP inc VAT |
| Unit Only - 30 cm / 12" | 967 89 39-12 | £332.50 | £399.00 |
| Unit + BLi200 & QC330 (recommended) | | £598.33 | £717.99 |

WORKING TIME ON ONE CHARGE

| T535i XP® | T540i XP® |
|----------------|-----------|
| PRUNING | |



| | | | |
|--|--------------------|------------|------------|
| | BLi100 | 1 h 30 min | 1 h 30 min |
| | BLi200 / X* | 3 h | 3 h |
| | BLi300 | 5 h 30 min | 5 h 30 min |

* BLi200X or BLi300 should be used with T540i XP®

T540 XP® II



Ultimate arborist chainsaw with excellent power to weight ratio designed for full time use by arboriculture and utility professionals.

- X-Torq®
- Low Vib®
- Customisable top handle
- Air Injection™
- Autotune™
- Secondary eyelet

| Displacement | Power output | Vibration levels F/R | Weight |
|---------------------|----------------|----------------------------|----------------|
| 377 cm ³ | 1.8kW / 2.4 hp | 3.5 / 4.2 m/s ² | 3.9 kg |
| Bar length | Order PNC | RRP ex VAT | RRP inc VAT |
| 30 cm / 12" | 967 28 75-12 | £574.17 | £689.00 |
| 35 cm / 14" | 967 28 75-14 | £582.50 | £699.00 |

T540i XP®



High performance battery powered arborist chainsaw offering high chainspeed. Low noise level and weatherproof (IPX4) make it ideal in noise sensitive areas.

- X-CUT™ SP21G chain
- Low noise
- 40cm³ petrol performance
- LED keypad with saveE™
- Secondary eyelet
- Weatherproof (IPX4)

| Voltage | Motor type | Vibration levels F/R | Weight |
|--|----------------|----------------------------|------------------------|
| 36V Li-ion | BLDC Brushless | 2.1 / 3.4 m/s ² | 2.5 kg (excl. battery) |
| Model | Order PNC | RRP ex VAT | RRP inc VAT |
| Unit Only - 30 cm / 12" | 967 86 37-12 | £490.83 | £589.00 |
| Unit Only - 35 cm / 14" | 967 86 37-14 | £499.17 | £599.00 |
| Unit 14" + BLi200X & QC330 (recommended) | | £764.99 | £917.99 |

REPLACEMENT CUTTING EQUIPMENT

| Model | T525 | T535i XP® | T 540 XP® II |
|------------------|----------------|---------------------|---------------------------|
| Bar | 25 cm / 10" | 30 cm / 12" | 30 cm / 12" |
| PNC | 587 39 44-60 | 593 91 43-51 | 582 20 76-45 |
| Ex VAT | £58.33 | £25.83 | £30.83 |
| Inc VAT | £69.99 | £30.99 | £36.99 |
| Chain | 25 cm / 10" | 30 cm / 12" | 30 cm / 12" |
| PNC | 501 84 40-60 | 593 91 41-51 | 585 40 42-45 |
| Ex VAT | £14.99 | £20.41 | £14.58 |
| Inc VAT | £17.99 | £24.49 | £17.49 |
| Technical | | | |
| Drive Links | 60 | 51 | 45 |
| Pitch | 1/4" | 0.325" Mini | 3/8" |
| Gauge | 1.3 mm / 0.50" | 1.1 mm / .043" | 1.3 mm / 0.50" |
| Type | H00 | X-CUT™ SP21G | X-CUT™ SP93G |
| Cutter | Micro chisel | Semi chisel Mini | Semi chisel low kick back |
| File Size | 4.0 mm / 5/32" | 4.0 mm / 5/32" | 4.0 mm / 5/32" |
| File Kit | | | |
| PNC | 580 68 75-01 | 595 00 46-01 | 587 80 67-01 |
| Ex VAT | £16.66 | £16.66 | £16.66 |
| Inc VAT | £19.99 | £19.99 | £19.99 |

| Model | T540 XP® II | T 540i XP® | |
|------------------|---------------------------|---------------------|---------------|
| Bar | 35 cm / 14" | 30 cm / 12" | 35 cm / 14" |
| PNC | 582 20 76-52 | 593 91 43-51 | 593 91 43-59 |
| Ex VAT | £33.74 | £25.83 | £29.99 |
| Inc VAT | £40.49 | £30.99 | £35.99 |
| Chain | 35 cm / 14" | 30 cm / 12" | 35 cm / 14" |
| PNC | 585 40 42-52 | 593 91 41-51 | 593 91 41-59 |
| Ex VAT | £17.08 | £20.42 | £23.33 |
| Inc VAT | £20.49 | £24.49 | £27.99 |
| Technical | | | |
| Drive Links | 52 | 51 | 59 |
| Pitch | 3/8" | 0.325" Mini | |
| Gauge | 1.3 mm / 0.50" | 1.1 mm / 0.43" | |
| Type | X-CUT™ S93G | X-CUT™ SP21G | |
| Cutter | Semi chisel low kick back | Semi chisel mini | |
| File Size | 4.0 mm / 5/32" | 4.0 mm / 5/32" | |
| File Kit | | | |
| PNC | 587 80 67-01 | 595 00 46-01 | |
| Ex VAT | £16.66 | £16.66 | |
| Inc VAT | £19.99 | £19.99 | |

“The T540i XP® has meant I get all the benefits of using battery products but with the added bonus of more power and cutting capacity to deal with larger diameter timber. I have been very impressed with this chainsaw and believe this is a game changer for the Arb industry.”

Josephine Hedger - H-TEAM Ambassador





POLE SAWS



Specialist professional polesaws designed for the pruning and thinning of trees or cutting back thick tall hedges from the ground. Fixed length versions designed for applications where a shorter length is required and telescopic versions for maximum reach.

Ideal for applications including:

- Forestry
- Arboriculture
- Horticulture
- Utilities maintenance
- Agriculture

530iP4



Robust fixed length battery pole saw designed for professional use. Lightweight and well balanced with petrol equivalent performance. Weatherproof (IPX4).

- 20 m/s chain speed
- Fixed length
- Low noise
- Keypad with savE™
- 250 cm length
- Slimline cutting head

| Voltage | Motor type | Vibration levels F/R | Weight |
|-------------------------------------|----------------|----------------------------|------------------------|
| 36V Li-ion | BLDC Brushless | 1.0 / 0.9 m/s ² | 3.4 kg (excl. battery) |
| Model | Order PNC | RRP ex VAT | RRP inc VAT |
| Unit only - 25 cm / 10" | 967 88 47-10 | £374.17 | £449.00 |
| Unit + BLi200 & QC330 (recommended) | | £639.99 | £767.99 |

530iPT5



Robust telescopic pole saw designed for professional use. Lightweight and well balanced with petrol equivalent performance. Weatherproof (IPX4).

- 20 m/s chain speed
- Telescopic
- Low noise
- Keypad with savE™
- 293 - 400 cm length
- Slimline cutting head

| Voltage | Motor type | Vibration levels F/R | Weight |
|-------------------------------------|----------------|----------------------------|-----------------------|
| 36V Li-ion | BLDC Brushless | 1.0 / 1.2 m/s ² | 50 kg (excl. battery) |
| Model | Order PNC | RRP ex VAT | RRP inc VAT |
| Unit only - 25 cm / 10" | 967 88 48-10 | £457.50 | £549.00 |
| Unit + BLi200 & QC330 (recommended) | | £723.33 | £867.99 |

WORKING TIME ON ONE CHARGE

530iP4 / 530iPT5

PRUNING

| | BLi100 | 50 min |
|--|-------------------|-------------|
| | BLi200 / X | 2 h |
| | BLi300 | 3 h 30 min |
| | BLi550X | 5 h 45 min |
| | BLi950X | 11 h 30 min |

525P4S



Robust fixed length petrol pole saw designed for professional use. Lightweight and well balanced.

- X-Torq®
- Smart Start®
- 240 cm length
- Low Vib®
- Fixed length

| Displacement | Power output | Vibration levels F/R | Weight |
|----------------------|----------------|----------------------------|----------------|
| 25.4 cm ³ | 1.0kW / 1.3 hp | 2.9 / 3.2 m/s ² | 5.3 kg |
| Bar length | Order PNC | RRP ex VAT | RRP inc VAT |
| 30 cm / 12" | 967 32 94-01 | £582.50 | £699.00 |

525PT5S



Robust telescopic petrol pole saw designed for professional use. Lightweight and well balanced.

- X-Torq®
- Smart Start®
- 280 - 397 cm length
- Low Vib®
- Telescopic
- Slimline cutting head

| Displacement | Power output | Vibration levels F/R | Weight |
|----------------------|----------------|----------------------------|----------------|
| 25.4 cm ³ | 1.0kW / 1.3 hp | 6.3 / 5.3 m/s ² | 7.0 kg |
| Bar length | Order PNC | RRP ex VAT | RRP inc VAT |
| 25 cm / 10" | 967 32 96-01 | £665.83 | £799.00 |

REPLACEMENT CUTTING EQUIPMENT

| Model | 525P4S | 530iP4 / 530iPT5 / 525PT5S |
|------------------|--------------------|----------------------------|
| Bar | 30 cm / 12" | 25 cm / 10" |
| PNC | 501 95 92-45 | 575 84 22-58 |
| Ex VAT | £21.66 | £19.16 |
| Inc VAT | £25.99 | £22.99 |
| Chain | 30 cm / 12" | 25 cm / 10" |
| PNC | 585 40 42-45 | 501 84 40-58 |
| Ex VAT | £14.58 | £14.58 |
| Inc VAT | £17.49 | £17.49 |
| Technical | | |
| Drive Links | 45 | 58 |
| Pitch | 3/8" | 1/4" |
| Gauge | 1.3 mm / 0.50" | 1.3 mm / 0.50" |
| Type | X-CUT™ S93G | H00 |
| Cutter | Semi chisel | Micro chisel |
| File Size | 4.0 mm / 5/32" | 4.0 mm / 5/32" |
| File Kit | | |
| PNC | 587 80 67-01 | 580 68 75-01 |
| Ex VAT | £16.66 | £16.66 |
| Inc VAT | £19.99 | £19.99 |

HUSQVARNA RECOMMEND

Working in wet conditions. Husqvarna rain clothing. Page 173



HUSQVARNA RECOMMEND

XP® Power 2 Fuel



There is no better fuel for your Husqvarna product than our alkylate fuel manufactured to unique Husqvarna specifications. XP® Power 2 is mixed with exactly 2% of our XP® 2-stroke oil giving you a cleaner, cooler and healthier engine. Read more on pages 180 - 181.



TECHNICAL SPECIFICATIONS

| | 545 II | 555 | 565 | 550 XP® II | 550 XP® G II | 560 XP® | 560 XP®G |
|--|---------------|---------------|---------------|---------------|---------------|---------------|---------------|
| TECHNICAL SPECIFICATIONS | | | | | | | |
| Cylinder displacement, cm ³ | 50.1 | 59.8 | 70.6 | 50.1 | 50.1 | 59.8 | 59.8 |
| Power output, kW | 2.7 | 3.1 | 3.7 | 3.0 | 3.0 | 3.5 | 3.5 |
| Sound pressure level at operators ear, dB(A)* | 106 | 106 | 105 | 107 | 107 | 106 | 106 |
| Sound power level guaranteed (LWA) dB(A)** | 116 | 118 | 119 | 117 | 117 | 118 | 118 |
| Equivalent vibration level (ahv, eq) front/rear handle, m/s ² *** | 3.7/3.6 | 3.2/5.0 | 5.2/5.3 | 4.4/4.1 | 4.4/4.1 | 4.4/5.3 | 4.4/5.3 |
| Chain pitch, inch | .325 | .325 / 3/8 | 3/8 | .325 | .325 | .325 / 3/8 | .325 / 3/8 |
| Recommended bar length, min-max, cm/inch | 33-45 / 13-18 | 33-45 / 13-18 | 45-70 / 18-28 | 33-45 / 13-18 | 33-45 / 13-18 | 33-50 / 13-20 | 33-50 / 13-20 |
| Weight (excl. cutting equipment), kg | 5.3 | 5.9 | 6.5 | 5.3 | 5.5 | 5.9 | 6.1 |
| FEATURES | | | | | | | |
| Adjustable oil pump | ● | ● | ● | ● | ● | ● | ● |
| Air Injection™ | ● | ● | ● | ● | ● | ● | ● |
| AutoTune™ | ● | ● | ● | ● | ● | ● | ● |
| Combined choke/stop control | ● | ● | ● | ● | ● | ● | ● |
| Fuel pump | ● | ● | ● | ● | ● | ● | ● |
| Heated carburettor | — | — | — | — | ● | — | ● |
| Heated handles | — | — | — | — | ● | — | ● |
| Inertia chain brake | ● | ● | ● | ● | ● | ● | ● |
| Low Vib® | ● | ● | ● | ● | ● | ● | ● |
| Magnesium crankcase | ● | ● | ● | ● | ● | ● | ● |
| Quick release air filter cover | ● | ● | ● | ● | ● | ● | ● |
| Quick-release air filter | ● | ● | ● | ● | ● | ● | ● |
| Retained bar nuts | ● | ● | ● | ● | ● | ● | ● |
| RevBoost™ | — | — | — | — | — | ● | ● |
| Side-mounted chain tensioner | ● | ● | ● | ● | ● | ● | ● |
| Smart Start® | ● | ● | ● | — | — | ● | ● |
| Snap-lock cylinder cover | ● | ● | ● | ● | ● | ● | ● |
| Tool-less chain tensioning | — | — | — | — | — | — | — |
| TrioBrake™ | — | — | — | — | — | — | — |
| Visible fuel level | ● | ● | ● | ● | ● | ● | ● |
| X-Torq® engine | ● | ● | ● | ● | ● | ● | ● |

● = Available (●) = Accessory — = Not available *Equivalent sound pressure level, according to ISO 22868, is calculated as the time-weighted energy total for different sound pressure levels under various working conditions. Typical statistical dispersion for equivalent sound pressure level is a standard deviation of 1 dB (A). **Noise emissions in the environment measured as sound power (LWA) in conformity with EC directive 2000/14/EC. The guaranteed sound power level includes variation in production as well as variation from the test code with 1-3 dB(A). ***Equivalent vibration level, according to ISO 22867, is calculated as the time-weighted energy total for vibration levels under various working conditions. Reported data for equivalent vibration level has a typical statistical dispersion (standard deviation) of 1 m/s².

! ALWAYS USE GENUINE HUSQVARNA LUBRICANTS AND SPARE PARTS FOR YOUR CHAINSAW

These high quality spare parts and lubricants are developed to facilitate the care and maintenance of your Husqvarna equipment and enable trouble-free operation and storage. Husqvarna recommend regular service done by qualified technicians using only Genuine Husqvarna original or recommended spare parts. This will support the product's performance and lifetime. See your owner's manual or consult your Authorised Husqvarna dealer if any uncertainty occurs.

NOMINAL POWER A new machinery directive (2006/42/EC) came into force on January 1, 2010, requiring manufacturers to declare the nominal power of engines, in kilowatts (kW). The power rating of the engines indicated is the average net power output during a normal working situations and meets applicable noise regulations (at specified rpm, see owner manual) of a typical production engine for the engine model measured to SAE standard J 1349/ISO 1585. Mass production engines may differ from this value. Actual power output for the engine installed in the final machine will depend on the operating speed, environmental conditions and other variables.



| | 562 XP® / XP G® | 572 XP® | 572 XP G® |
|--|-----------------|-------------|-------------|
| TECHNICAL SPECIFICATIONS | | | |
| Cylinder displacement, cm ³ | 59.8 | 70.6 | 70.6 |
| Power output, kW | 3.5 | 4.3 | 4.3 |
| Sound pressure level at operators ear, dB(A)* | 106 | 107 | 107 |
| Sound power level guaranteed (LWA) dB(A)** | 118 | 120 | 120 |
| Equivalent vibration level (ahv, eq) front/rear handle, m/s ² *** | 3.2/5.0 | 5.0/4.1 | 5.0/4.1 |
| Chain pitch, inch | 3/8 | 3/8 | 3/8 |
| Recommended bar length, min-max, cm/inch | 37-70/15-28 | 37-70/15-28 | 37-70/15-28 |
| Weight (excl. cutting equipment), kg | 6.1/6.3 | 6.6 | 6.8 |
| FEATURES | | | |
| Adjustable oil pump | ● | ● | ● |
| Air Injection™ | ● | ● | ● |
| AutoTune™ | ● | ● | ● |
| Combined choke/stop control | ● | ● | ● |
| Fuel pump | ● | ● | ● |
| Heated carburettor | - / ● | - | ● |
| Heated handles | - / ● | - | ● |
| Inertia chain brake | ● | ● | ● |
| Low Vib® | ● | ● | ● |
| Magnesium crankcase | ● | ● | ● |
| Quick release air filter cover | ● | ● | ● |
| Quick-release air filter | ● | ● | ● |
| Retained bar nuts | ● | ● | ● |
| RevBoost™ | ● | - | - |
| Side-mounted chain tensioner | ● | ● | ● |
| Smart Start® | ● | ● | ● |
| Snap-lock cylinder cover | ● | ● | ● |
| Tool-less chain tensioning | - | - | - |
| TrioBrake™ | - | - | - |
| Visible fuel level | ● | ● | ● |
| X-Torq® engine | ● | ● | ● |



| TOP HANDLE CHAINSAW | T525 | T540 XP II |
|--|---------|-------------|
| TECHNICAL SPECIFICATIONS | | |
| Cylinder displacement, cm ³ | 27.0 | 37.7 |
| Power output, kW | 1.1 | 1.8 |
| Sound pressure level at operators ear, dB(A)* | 98 | 104.0 |
| Sound power level guaranteed (LWA) dB(A)** | 111 | 116 |
| Equivalent vibration level (ahv, eq) front/rear handle, m/s ² *** | 4.9/5.2 | 3.5 / 4.2 |
| Chain pitch, inch | 1/4 | 3/8 |
| Recommended bar length, min-max, cm/inch | 25/10 | 30-35/12-14 |
| Weight (excl. cutting equipment), kg | 2.7 | 3.9 |
| FEATURES | | |
| Adjustable oil pump | ● | ● |
| Air Injection™ | ● | ● |
| AutoTune™ | - | ● |
| Fuel pump | ● | ● |
| Horizontal rope eye let | ● | ● |
| Inertia chain brake | ● | ● |
| Low Vib® | ● | ● |
| Magnesium crankcase | - | ● |
| Quick release air filter cover | ● | ● |
| Quick-release air filter | ● | ● |
| Visible fuel level | ● | ● |
| X-Torq® engine | ● | ● |

| POLE SAWS | 525P4S | 525PT5S |
|--|-------------|-------------|
| TECHNICAL SPECIFICATIONS | | |
| Cylinder displacement, cm ³ | 25.4 | 25.4 |
| Power output, kW | 1.0 | 1.0 |
| Sound pressure level at operators ear, dB(A)* | 91 | 89 |
| Sound power level guaranteed (LWA) dB(A) | 107 | 107 |
| Equivalent vibration level (ahv, eq) front/rear handle, m/s ² *** | 2.9/3.2 | 6.3/5.3 |
| Chain pitch, inch | 3/8 LP | 1/4 |
| Recommended bar length, min-max, cm/inch | 25-30/10-12 | 25-30/10-12 |
| Max. length with cutting equipment, cm | 240 | 397 |
| Weight (excl. cutting equipment), kg | 5.3 | 7.0 |
| FEATURES | | |
| Auto-return stop switch | ● | ● |
| Chain lubrication | ● | ● |
| Chain tensioner | ● | ● |
| Fuel pump | ● | ● |
| Rear impact guard | ● | ● |
| Stand alone starter | ● | ● |
| Telescopic tube | - | ● |



GIVE YOUR CHAINSAW EXTRA PERFORMANCE



Husqvarna bars and chains are built to the same high standard as our saws. By combining high quality materials with product development based on the demands of forestry professionals, we can specify the bar and chain combinations that deliver maximum efficiency and cutting performance with your Husqvarna chainsaw. Our **X-CUT™** chains and **X-FORCE™** bars are developed with our saws, giving you the optimal total performance you need to get the most out of your chainsaw.



WHAT YOU GET AND HOW WE DO IT

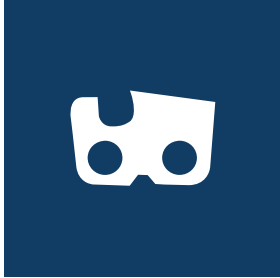

HUSQVARNA FOR YOUR HUSQVARNA
Husqvarna manufactured bars and chains have been developed to work optimally with our chainsaws, increasing your output and cutting efficiency.



EASY MAINTENANCE
Our bars and chains offer you a product with easier maintenance and a design that gives longer product lifetime with minimal downtime.



TOUGHER AND MORE DURABLE
Improved durability across our new bars and chains give an extended product lifetime and minimal down time which reduces overall cost of ownership and increases productivity.



10% MORE EFFICIENT
After rigorous testing, our **X-CUT™ SP33G** chain has been found to give 10% more cutting efficiency* increasing your output and productivity.



MADE IN SWEDEN
Our **X-CUT™** chains have been researched, designed and manufactured in our state-of-the-art factory in Huskvarna, Sweden** to give optimal output with our chainsaws.



* Compared to our H30 chain

**SP21G not manufactured in Sweden



MINIMUM DOWNTIME, MAXIMUM RESULTS

Our **X-CUT™** chains are the first ever saw chain to be developed, designed and manufactured by Husqvarna, in Sweden where our chainsaws are developed and tested. Husqvarna **X-CUT™** is designed to maximise your output, allowing you to work harder for longer without interruptions.

MORE RUN TIME AND LESS MAINTENANCE

Cutters, materials and manufacturing processes are refined to the extreme, giving the **X-CUT™** chain outstanding sharpness out of the box, and even more importantly — sharpness that lasts considerably longer before filing is needed.

GOLDEN TIE STRAP

Thanks to the intuitive golden tie strap function, you easily locate the starting point, simplifying the filing of the chain.

BETTER RESULTS, EASIER WORK

X-CUT™ is made for making faster cuts, and it's ready to be used straight out of the box. This improves your efficiency — and your results. The smooth cutting reduces the feed force needed, making the work easier on your body.



LESS ADJUSTMENTS AND LESS RISK OF DAMAGE

The **X-CUT™** chain is pre-stretched at the factory so you can work longer before re-tensioning is needed. No unnecessary chain tension required. The risk of damaging the cutting system with a slack chain is also decreased.

LESS COST AND LESS SERVICE

A carefully balanced combination of construction, materials and processes mean excellent, dynamic durability. Wear on the cutting system is reduced — and so is the need for service.

X-CUT™ CHAIN



HUSQVARNA X-CUT™ SP33G

Semi-chisel pixel .325" 1.3 mm chain developed and manufactured by Husqvarna. Low kick guard, narrow kerf, low stretch and bumper drive link. Developed for demanding professional use on mid-size chainsaws, up to 55 cm³. Original equipment on most Husqvarna 400 series chainsaws.



HUSQVARNA X-CUT™ S93G

The semi chisel 3/8" mini 1.3 mm S93G chain is developed to fit smaller chainsaws like the 100 Series or arborist top-handle saws. Optimised geometry and grinding provides high cutting speed. High cutting efficiency balanced against the available power from the chainsaw will enable a smooth and precise cut.



HUSQVARNA X-CUT™ SP21G

SP21G is a semi chisel .325" mini 1.1 mm chain especially developed to increase the cutting speed and efficiency for full-time professional use battery chainsaws. The chain is energy efficient and the optimised geometry delivers a consistently smooth cut, excellent bore cut as well as improved handling and manoeuvrability.



HUSQVARNA X-CUT™ C85

An advanced, full chisel, high performance 3/8" 1.5 mm chain for full-time professional forestry saws. With its outstanding durability and cutting efficiency, a sharpness that lasts and low stretch, it gives you better results, less need for maintenance and lower costs.

GET THE PERFORMANCE PACKAGE FOR YOUR HUSQVARNA CHAINSAW

All of our **X-CUT™** chains are tested and developed with our chainsaws, ensuring they give you maximum performance and the best cutting efficiency when used with our saws.

Read more about our bars and chains on our website:
www.husqvarna.com/uk





“The **X-CUT™ C85** is the sharpest and most durable low stretch chain I have ever used. The quality and quantity of wood chips on the ground speak for themselves!”

Andy Campbell - H-TEAM Ambassador



USING DIFFERENT CHAINS

Husqvarna offers a wide range of chains for different needs. Use the chart below to find the recommended chain for your chainsaw:

| PITCH | RECOMMENDED cm ³ | HUSQVARNA REF | CUTTER TYPE |
|-----------------|--------------------------------------|---------------------|-----------------------------|
| 1/4" | Polesaws, carving, battery chainsaws | H00 | Micro chisel |
| 3/8" Mini Pixel | Battery chainsaws | H38 | Chamfer chisel low kickback |
| .325" Mini | Battery chainsaws | X-CUT™ SP21G | Mini - semi chisel |
| 3/8" Mini | up to 40cc / Arborist chainsaws | X-CUT™ S93G | Semi chisel low kickback |
| Pixel .325" | 40cc - 50 cm ³ | X-CUT™ SP33G | Pixel - semi chisel |
| .325" | 50cc - 60 cm ³ | H25 | Semi chisel |
| 3/8" | 60cc - 95 cm ³ | X-CUT™ C85 | Chisel |
| .404" | 95cc - 120 cm ³ | H64 | Chisel |

CHAIN REELS

| ITEM | PNC | RRP EX VAT | RRP INC VAT |
|--|--------------|------------|----------------|
| 100' H21 Chisel 0.325" 1.5 mm | 503 30 57-01 | £407.50 | £489.00 |
| 100' H25 Semi Chisel 0.325" 1.5 mm | 503 30 55-01 | £374.17 | £449.00 |
| 100' H28 Micro Chisel 0.325" 1.6 mm | 503 30 03-22 | £374.17 | £449.00 |
| 100' X-CUT™ SP33G Pixel - Semi Chisel 0.325" 1.3 mm | 581 64 31-01 | £532.50 | £639.00 |
| 100' X-CUT™ S93G Semi Chisel Low Kickback 3/8" 1.3 mm | 585 40 42-01 | £474.17 | £569.00 |
| 100' H38 Chamfer Chisel 3/8" 1.1 mm | 581 80 79-01 | £475.00 | £570.00 |
| 100' X-CUT™ C85 Chisel 3/8" 1.5 mm | 581 62 66-01 | £499.17 | £599.00 |
| 100' H45 Chisel 3/8" 1.6 mm | 503 30 88-01 | £470.83 | £565.00 |
| 100' H64 Micro Chisel 0.404" 1.6 mm | 503 30 64-01 | £495.83 | £595.00 |



DESIGNED BY HUSQVARNA FOR YOUR HUSQVARNA



X-FORCE™ is Husqvarna's answer to the challenge for the perfect guide bar – that is both lightweight and low-maintenance to minimise your burden, yet durable enough to withstand tough work over long time. Husqvarna **X-FORCE™** guide bars are developed alongside Husqvarna **X-CUT™** chains, optimised for Husqvarna chainsaws. The result is a cutting system that makes your chainsaw perform on an entirely new level – delivering a fast, precise kerf with minimal friction loss.



PROLONG YOUR BAR AND CHAIN LIFE

Always use Husqvarna chain oil. Incorrect use of chain oil is a common source of damage to saws and tends to lead to rapid wear of the bar, or the chain jamming or derailing. Our full range of chain oils can be found on page 183.

KEEPING STANDARDS

Testing and fulfilling ISO, EN and ANSI standards and internal standards is a priority in the development of new Husqvarna accessories. Regular testing during production ensures lasting quality.



HUSQVARNA XP® POWER 2

FUEL DEVELOPED SPECIFICALLY FOR HUSQVARNA TWO-STROKE ENGINES

There is no better fuel for your Husqvarna chainsaw than our XP® Power 2 manufactured to unique Husqvarna specifications. Conveniently pre-mixed with exactly 2% of Husqvarna XP® synthetic two-stroke oil, it provides efficient combustion leaving a cleaner, cooler, healthier engine with a minimum of harmful substances in the emissions. It also prevents inner corrosion, makes starting easier, reduces the need for service and minimises downtime. VEF approved.

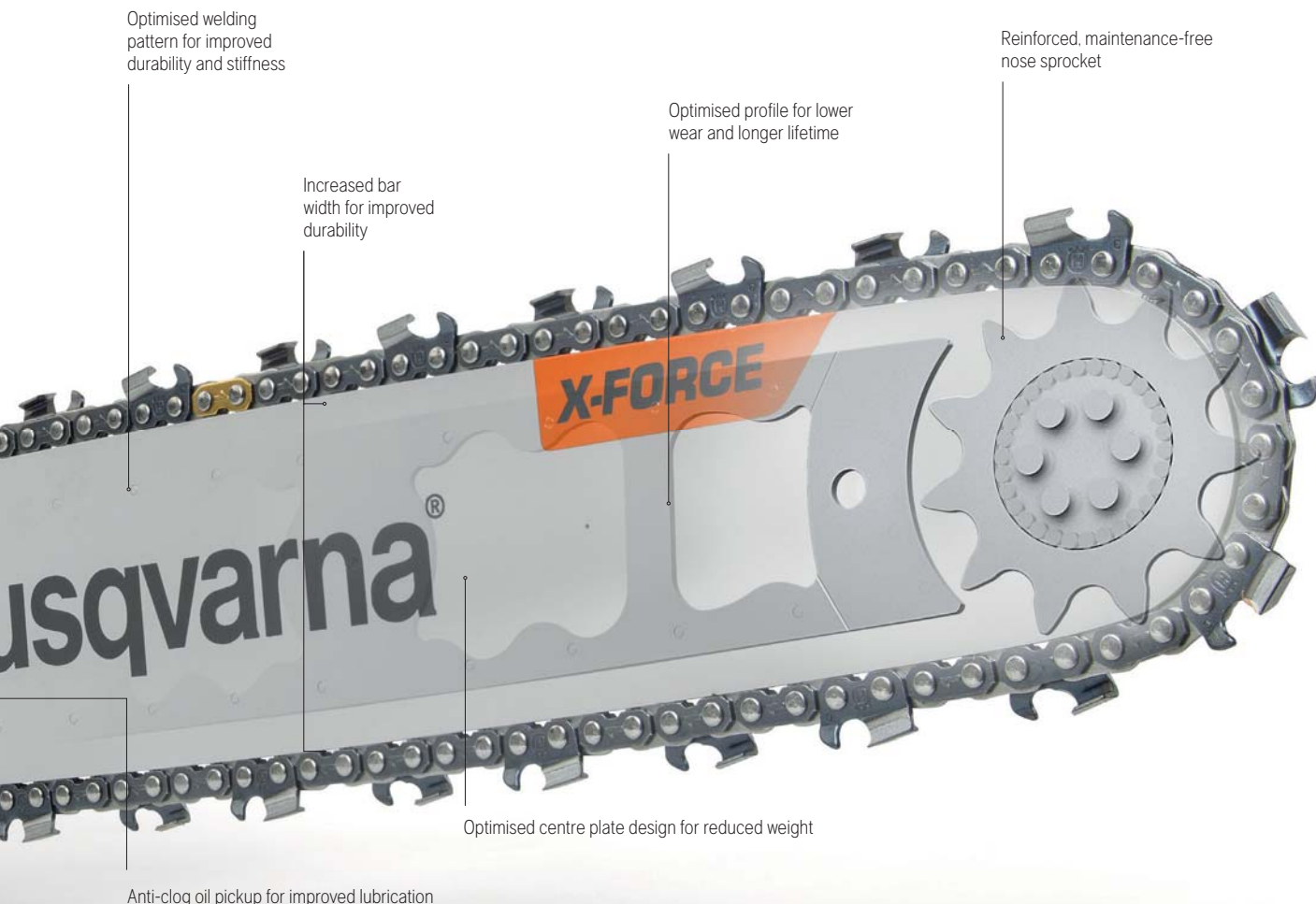

Anti-clog oil pickup for improved lubrication

USING DIFFERENT BARS



X-FORCE™ BARS

The **X-FORCE™** laminated bars offer easier maintenance and increased productivity. Depending on the model, these benefits come from features such as updated profiles, larger nose sprocket, cutouts in the centre plate, additional bearings, supported shields, and the removal of the grease hole. Available in 3/8" (15–20"), 3/8" Mini (12–14") and .325" (13–20").



HUSQVARNA X-TOUGH™ BARS WITH REPLACEABLE SPROCKET NOSE

Solid RSN bar with great durability and robustness. The load is transferred to the high-quality roller bearing. The bars are coated to protect against scratches and corrosion. Replaceable tip is available as a spare part. Available in 3/8" (18–28").



HUSQVARNA X-TOUGH™ BARS WITH HARD NOSE

Recommended for use with long bars to reduce load on the bar tip. The load is transferred to the high-quality roller bearing. The bars are coated to protect against scratches and corrosion. Replaceable tip is available as a spare part. Available with 3/8" chain pitch in lengths 18–28"



LAMINATED BARS WITH NOSE SPROCKET

The gentle curve and small nose radius reduce the risk of kickback and facilitates good cutting control. Coated bars to protect against scratches and corrosion. Available in 3/8" Mini (10–16").



CARVING BAR - SMALL MOUNT

Carving bars have a smaller nose radius and are suitable for sculpting and other precision work. Available in 1/4" (10–12").

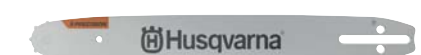

HUSQVARNA X-PRECISION™ BARS

The X-Precision™ bars are designed specifically for use with the X-Cut™ SP21G chain on battery-powered professional chainsaws. The optimised overall geometry and small nose radius provide efficient cutting with precise control, excellent bore cutting properties and reduced risk of kickback. Available in .325" mini (10–16").





BAR & CHAIN GUIDE

Use this guide to help you select the best bar, chain and filing kit for your Husqvarna chainsaw.

| SMALL BAR MOUNTING POINT | | | | | | | | | | | | | | | LARGE BAR MOUNTING POINT | BARS | | | | | | | | | | | | | | | | | | | | | | | | |
|--|------|------|----------|-------------------------|-------------------|---------------|--------------|-------------------|---------------------|------------|-----------------------|-------------------------------------|-------------------------------|-----------------------|--------------------------|------|------------------|-------------------------------|---------|-----|---------------|---------|-----------------------------|---------------|---------------|-------------------------|-------------------|---------|----------|----------------------|------------------|-----------------|--|---------|---------|------------|------------|------------|------------|------------|
| 115IPT4 / 120ITK4-P / 530IP4 & PT5 | T525 | T435 | T540 XP® | 327P4 / 327P5X / 525P4S | 327PT5S / 525PT5S | 420EL / 321EL | 136LI / 120i | 436LI / 536LI XP® | 535i XP® / 540i XP® | T536LI XP® | T535i XP® / T540i XP® | 136 / 141 / 137 / 142 / 137e / 142e | 235 / 236 / 240 / 236e / 240e | 120 / 130 / 135 / 140 | 435 / 435e / 440 / 440e | 340i | 445 / 445e / 450 | 545 / 550 XP® / 353 / 346 XP® | 357 XP® | 455 | 555 / 560 XP® | 562 XP® | 281 XP® / 288 XP® / 394 XP® | 365 / 372 XP® | 565 / 572 XP® | 576 XP® / 575 XP® / 570 | 385 XP® / 390 XP® | 395 XP® | 3120 XP® | BAR LENGTH INCH / cm | CHAIN PITCH INCH | GAUGE INCH / mm | | | | | | | | |
| LAMINATED BAR WITH NOSE WHEEL | | | | | | | | | | | | | | | | | | | | | | | | | | | | | | | | | | | | | | | | |
| ● | | | | ● | | | | | | | | | | | | | | | | | | | | | | | | | | | | | | 10 / 25 | 1 / 4 | .050 / 1.3 | | | | |
| | | | | | | | | | | | | | | | | | | | | | | | | | | | | | | | | | | | 10 / 25 | 3 / 8 | .050 / 1.3 | | | |
| | ● | | ● | | | | | | | | | | | | | | | | | | | | | | | | | | | | | | | | 12 / 30 | 3 / 8 | .050 / 1.3 | | | |
| | | | | | | | | | | | | ● | ● | | | ● | | | | | | | | | | | | | | | | | | | | 14 / 35 | 3 / 8 | .050 / 1.3 | | |
| | | | | | | | | | | | | | | | | | | | | | | | | | | | | | | | | | | | | 16 / 40 | 3 / 8 | .050 / 1.3 | | |
| | | | | | | | | ● | | | | | | | | | | | | | | | | | | | | | | | | | | | | 12 / 30 | 3 / 8 | .043 / 1.1 | | |
| | | | | | | | | ● | ● | ● | | | | | | | | | | | | | | | | | | | | | | | | | | 14 / 35 | 3 / 8 | .043 / 1.1 | | |
| 0.325" LAMINATED BAR | | | | | | | | | | | | | | | | | | | | | | | | | | | | | | | | | | | | | | | | |
| | | | | | | | | ● | | ● | | | | | | | | | | | | | | | | | | | | | | | | | | 10 / 25 | 0.325 | .043 / 1.1 | | |
| | | | | | | | | ● | | ● | | | | | | | | | | | | | | | | | | | | | | | | | | | 12 / 30 | 0.325 | .043 / 1.1 | |
| | | | | | | | | ● | | ● | | | | | | | | | | | | | | | | | | | | | | | | | | | 14 / 35 | 0.325 | .043 / 1.1 | |
| | | | | | | | | ● | | ● | | | | | | | | | | | | | | | | | | | | | | | | | | | 16 / 40 | 0.325 | .043 / 1.1 | |
| 0.325" X-FORCE™ LAMINATED BAR | | | | | | | | | | | | | | | | | | | | | | | | | | | | | | | | | | | | | | | | |
| | | | | | | | | | | | | | | | ● | ● | ○ | | | | | | | | | | | | | | | | | | | 13 / 33 | 0.325 | .050 / 1.3 | | |
| | | | | | | | | | | | | ● | | ● | ● | ○ | | | | | | | | | | | | | | | | | | | | | 15 / 38 | 0.325 | .050 / 1.3 | |
| | | | | | | | | | | | | | | | ● | ● | ○ | | | | | | | | | | | | | | | | | | | | 18 / 45 | 0.325 | .050 / 1.3 | |
| | | | | | | | | | | | | | | | | | ● | ● | ● | ● | | | | | | | | | | | | | | | | | 13 / 33 | 0.325 | .058 / 1.5 | |
| | | | | | | | | | | | | | | | | | ● | ● | ● | ● | | | | | | | | | | | | | | | | | 15 / 38 | 0.325 | .058 / 1.5 | |
| | | | | | | | | | | | | | | | | | ● | ● | ● | ● | | | | | | | | | | | | | | | | | 18 / 45 | 0.325 | .058 / 1.5 | |
| | | | | | | | | | | | | | | | | | | ● | ● | | | | | | | | | | | | | | | | | | 20 / 50 | 0.325 | .058 / 1.5 | |
| 3/8" X-FORCE™ PRO LAMINATED BAR | | | | | | | | | | | | | | | | | | | | | | | | | | | | | | | | | | | | | | | | |
| | | | | | | | | | | | | | | | | | | ● | | | | | | | | | | | | | | | | | | | 15 / 38 | 3 / 8 | .058 / 1.5 | |
| | | | | | | | | | | | | | | | | | | ● | | | | | | | | | | | | | | | | | | | | 18 / 45 | 3 / 8 | .058 / 1.5 |
| | | | | | | | | | | | | | | | | | | ● | | | | | | | | | | | | | | | | | | | | 20 / 50 | 3 / 8 | .058 / 1.5 |
| | | | | | | | | | | | | | | | | | | | ● | ● | ● | ● | ● | | | | | | | | | | | | | | 15 / 38 | 3 / 8 | .058 / 1.5 | |
| | | | | | | | | | | | | | | | | | | | ● | ● | ● | ● | ● | | | | | | | | | | | | | | 18 / 45 | 3 / 8 | .058 / 1.5 | |
| | | | | | | | | | | | | | | | | | | | | ● | ● | ● | ● | ● | ● | ● | | | | | | | | | | | 20 / 50 | 3 / 8 | .058 / 1.5 | |
| 3/8" MINI X-FORCE™ PRO LAMINATED BAR | | | | | | | | | | | | | | | | | | | | | | | | | | | | | | | | | | | | | | | | |
| | | ● | | | | | | | | | | | | | | | | | | | | | | | | | | | | | | | | | | | 12 / 30 | 3 / 8 | .050 / 1.3 | |
| | | ● | | | | | | | | | | | | | | | | | | | | | | | | | | | | | | | | | | | | 14 / 35 | 3 / 8 | .050 / 1.3 |
| SOLID BAR WITH REPLACEABLE NOSE WHEEL | | | | | | | | | | | | | | | | | | | | | | | | | | | | | | | | | | | | | | | | |
| | | | | | | | | | | | | | | | | | | | | | | ● | ● | ● | ● | ● | ● | ● | | | | | | | | | 24 / 60 | 3 / 8 | .058 / 1.5 | |
| | | | | | | | | | | | | | | | | | | | | | | ○ | ○ | ○ | ○ | ○ | ● | ● | | | | | | | | | 28 / 70 | 3 / 8 | .058 / 1.5 | |
| SOLID BAR | | | | | | | | | | | | | | | | | | | | | | | | | | | | | | | | | | | | | | | | |
| | | | | | | | | | | | | | | | | | | | | | | | | | | | | | | | | | | | | | | 30 / 75 | 0.404 | .063 / 1.6 |
| | | | | | | | | | | | | | | | | | | | | | | | | | | | | | | | | | | | | | | 36 / 90 | 0.404 | .063 / 1.6 |
| | | | | | | | | | | | | | | | | | | | | | | | | | | | | | | | | | | | | | | 42 / 105 | 0.404 | .063 / 1.6 |
| CARVING BAR | | | | | | | | | | | | | | | | | | | | | | | | | | | | | | | | | | | | | | | | |
| | ● | | | | | | | ● | ● | | | | | | | | | | | | | | | | | | | | | | | | | | | | 10 / 25 | 1 / 4 | .050 / 1.3 | |
| | ● | | | | | | | ● | ● | | | | | | | | | | | | | | | | | | | | | | | | | | | | | 12 / 30 | 1 / 4 | .050 / 1.3 |

● Optimised solution (guideline only) ○ Capable solution but not optimal (guideline only)



| | | | | CHAINS | | | | | | FILE KITS | |
|--------------|---------------|----------------|--------------|---------------------|-----------------------------|-------------|---------------|----------------|--|----------------|--|
| BAR | PRICE EX. VAT | PRICE INC. VAT | CHAIN | TYPE | CUTTER | DRIVE LINKS | PRICE EX. VAT | PRICE INC. VAT | FILE KIT £19.99 INC VAT £16.66 EX VAT | FILE SIZE | |
| 575 84 22-58 | £1916 | £22.99 | 50184 40-58 | H00 | MICRO CHISEL | 58 | £14.58 | £17.49 | 580 68 75-01 | 4.0 mm / 5/32" | |
| 501 95 92-40 | £16.66 | £19.99 | 585 40 42-40 | X-CUT™ S93G | SEMI CHISEL LOW KICKBACK | 40 | £12.91 | £15.49 | 587 80 67-01 | 4.0 mm / 5/32" | |
| 501 95 92-45 | £21.66 | £25.99 | 585 40 42-45 | X-CUT™ S93G | SEMI CHISEL LOW KICKBACK | 45 | £14.58 | £17.49 | 587 80 67-01 | 4.0 mm / 5/32" | |
| 501 95 92-52 | £23.33 | £27.99 | 585 40 42-52 | X-CUT™ S93G | SEMI CHISEL LOW KICKBACK | 52 | £17.08 | £20.49 | 587 80 67-01 | 4.0 mm / 5/32" | |
| 501 95 92-56 | £26.66 | £31.99 | 585 40 42-56 | X-CUT™ S93G | SEMI CHISEL LOW KICKBACK | 56 | £18.33 | £21.99 | 587 80 67-01 | 4.0 mm / 5/32" | |
| 582 20 74-45 | £30.83 | £36.99 | 581 80 79-45 | H38 | CHAMFER CHISEL LOW KICKBACK | 45 | £12.91 | £15.49 | - | 4.5 mm | |
| 582 20 74-52 | £33.74 | £40.49 | 581 80 79-52 | H38 | CHAMFER CHISEL LOW KICKBACK | 52 | £14.99 | £17.99 | - | 4.5 mm | |
| 593 91 43-46 | £20.83 | £24.99 | 593 91 41-46 | X-CUT™ SP21G | MINI - SEMI CHISEL | 46 | £18.33 | £21.99 | 595 00 46-01 | 4.0 mm / 5/32" | |
| 593 91 43-51 | £25.83 | £30.99 | 593 91 41-51 | X-CUT™ SP21G | MINI - SEMI CHISEL | 51 | £20.41 | £24.49 | 595 00 46-01 | 4.0 mm / 5/32" | |
| 593 91 43-59 | £29.99 | £35.99 | 593 91 41-59 | X-CUT™ SP21G | MINI - SEMI CHISEL | 59 | £23.33 | £27.99 | 595 00 46-01 | 4.0 mm / 5/32" | |
| 593 91 43-64 | £36.66 | £43.99 | 593 91 41-64 | X-CUT™ SP21G | MINI - SEMI CHISEL | 64 | £25.41 | £30.49 | 595 00 46-01 | 4.0 mm / 5/32" | |
| 582 07 53-56 | £37.08 | £44.49 | 581 64 31-56 | X-CUT™ SP33G | PIXEL - SEMI CHISEL | 56 | £19.16 | £22.99 | 586 93 34-01 | 4.8 mm / 3/16" | |
| 582 07 53-64 | £42.92 | £51.49 | 581 64 31-64 | X-CUT™ SP33G | PIXEL - SEMI CHISEL | 64 | £22.08 | £26.49 | 586 93 34-01 | 4.8 mm / 3/16" | |
| 582 07 53-72 | £51.66 | £61.99 | 581 64 31-72 | X-CUT™ SP33G | PIXEL - SEMI CHISEL | 72 | £24.58 | £29.49 | 586 93 34-01 | 4.8 mm / 3/16" | |
| 582 08 69-56 | £37.08 | £44.49 | 501 84 04-56 | H25 | SEMI CHISEL | 56 | £15.83 | £18.99 | 505 69 81-25 | 4.8 mm / 3/16" | |
| 582 08 69-64 | £42.91 | £51.49 | 501 84 04-64 | H25 | SEMI CHISEL | 64 | £17.91 | £21.49 | 505 69 81-25 | 4.8 mm / 3/16" | |
| 582 08 69-72 | £51.66 | £61.99 | 501 84 04-72 | H25 | SEMI CHISEL | 72 | £20.41 | £24.49 | 505 69 81-25 | 4.8 mm / 3/16" | |
| 582 08 69-80 | £57.49 | £68.99 | 501 84 04-80 | H25 | SEMI CHISEL | 80 | £22.49 | £26.99 | 505 69 81-25 | 4.8 mm / 3/16" | |
| 585 94 34-56 | £42.91 | £51.49 | 581 62 66-56 | X-CUT™ C85 | CHISEL | 56 | £19.58 | £23.49 | 586 93 85-01 | 5.5 mm / 7/32" | |
| 585 94 34-68 | £51.66 | £61.99 | 581 62 66-68 | X-CUT™ C85 | CHISEL | 68 | £24.16 | £28.99 | 586 93 85-01 | 5.5 mm / 7/32" | |
| 585 94 34-72 | £57.49 | £68.99 | 581 62 66-72 | X-CUT™ C85 | CHISEL | 72 | £25.41 | £30.49 | 586 93 85-01 | 5.5 mm / 7/32" | |
| 585 95 08-56 | £42.91 | £51.49 | 581 62 66-56 | X-CUT™ C85 | CHISEL | 56 | £19.58 | £23.49 | 586 93 85-01 | 5.5 mm / 7/32" | |
| 585 95 08-68 | £51.66 | £61.99 | 581 62 66-68 | X-CUT™ C85 | CHISEL | 68 | £24.16 | £28.99 | 586 93 85-01 | 5.5 mm / 7/32" | |
| 585 95 08-72 | £57.49 | £68.99 | 581 62 66-72 | X-CUT™ C85 | CHISEL | 72 | £25.41 | £30.49 | 586 93 85-01 | 5.5 mm / 7/32" | |
| 582 20 76-45 | £30.83 | £36.99 | 585 40 42-45 | X-CUT™ S93G | SEMI CHISEL LOW KICKBACK | 45 | £14.58 | £17.49 | 587 80 67-01 | 4.0 mm / 5/32" | |
| 582 20 76-52 | £33.74 | £40.49 | 585 40 42-52 | X-CUT™ S93G | SEMI CHISEL LOW KICKBACK | 52 | £17.08 | £20.49 | 587 80 67-01 | 4.0 mm / 5/32" | |
| 596 69 11-84 | £86.66 | £103.99 | 581 62 66-84 | X-CUT™ C85 | CHISEL | 84 | £29.58 | £35.49 | 586 93 85-01 | 5.5 mm / 7/32" | |
| 596 69 11-92 | £99.99 | £119.99 | 581 62 66-92 | X-CUT™ C85 | CHISEL | 92 | £32.49 | £38.99 | 586 93 85-01 | 5.5 mm / 7/32" | |
| 596 69 10-92 | £108.33 | £129.99 | 501 84 31-92 | H64 | CHISEL | 92 | £30.83 | £36.99 | 505 69 81-92 | 5.5 mm / 7/32" | |
| 596 69 10-04 | £133.33 | £159.99 | 501 84 31-04 | H64 | CHISEL | 104 | £34.99 | £41.99 | 505 69 81-92 | 5.5 mm / 7/32" | |
| 596 69 10-24 | £154.16 | £184.99 | 501 84 31-24 | H64 | CHISEL | 124 | £41.66 | £49.99 | 505 69 81-92 | 5.5 mm / 7/32" | |
| 587 39 44-60 | £58.33 | £69.99 | 501 84 40-60 | H00 | MICRO CHISEL | 60 | £14.99 | £17.99 | 580 68 75-01 | 4.0 mm / 5/32" | |
| 587 39 44-68 | £64.16 | £76.99 | 501 84 40-68 | H00 | MICRO CHISEL | 68 | £20.41 | £24.49 | 580 68 75-01 | 4.0 mm / 5/32" | |

X-CUT™ S93G

Replaces H37



X-CUT™ SP21G



X-CUT™ SP33G

Replaces H30



X-CUT™ C85

Replaces H42



X-CUT™ S93G

X-CUT™ C85



FILING EQUIPMENT



A sharp chain is as important as a powerful engine. For your chainsaw to operate effectively, safely and with precision it is vital to have a sharp chain. How often it needs to be sharpened depends on how frequently you use it. A good indication of the condition of your chain is the appearance of the wood chips. A sharp chain will produce fine, even wood chips, while a dull chain generates sawdust. You'll need a round file, a flat file and a filing gauge to file a chain. We also recommend that you use a stump vise to hold the bar, leaving both hands free for filing.



FILING THE CUTTING TEETH

File using light and even pressure, with gentle pushing strokes, parallel to the gauge. Try to get the same length of all cutters.

INTENSIVE ROUND CUT FILES

Designed for optimal cutting performance and longer lifetime.



| Item | Order PNC | RRP ex VAT | RRP inc VAT |
|------------------|--------------|------------|---------------|
| 4.0 mm - 3 pack | 597 35 48-01 | £4.16 | £4.99 |
| 4.0 mm - 12 pack | 597 35 48-02 | £14.16 | £16.99 |
| 4.5 mm - 3 pack | 597 35 55-01 | £4.16 | £4.99 |
| 4.8 mm - 3 pack | 597 35 58-01 | £4.16 | £4.99 |
| 4.8 mm - 12 pack | 597 35 58-02 | £14.16 | £16.99 |
| 5.5 mm - 3 pack | 597 35 61-01 | £4.16 | £4.99 |
| 5.5 mm - 12 pack | 597 35 61-02 | £14.16 | £16.99 |

FLAT FILES

Quality files which give you the right geometry of the cutter.



| Item | Order PNC | RRP ex VAT | RRP inc VAT |
|-------------------------|--------------|------------|---------------|
| Flat files 6" - 12 pack | 505 69 81-61 | £29.16 | £34.99 |
| Flat files 8" - 12 pack | 505 69 81-81 | £37.49 | £44.99 |

FILE HANDLE



Patented file locking system. Fits all our files. 25° and 30° guides ensures correct file angling.

| Item | Order PNC | RRP ex VAT | RRP inc VAT |
|--|--------------|------------|--------------|
| File handle - Round files Ø 4.5-5.5 mm | 505 69 78-01 | £2.49 | £2.99 |
| File handle - Flat files | 505 69 78-10 | £2.49 | £2.99 |



FILING THE DEPTH GAUGE

File all the way down to the gauge. If you file the depth gauge without a tool you, risk filing them too far down and the chain will produce chips which are too thick.



FILE GAUGES

Specifically designed file gauges that give the correct filing angles. Use together with our round files.



| Item | Order PNC | RRP ex VAT | RRP inc VAT |
|---------------------|--------------|------------|--------------|
| .325" H25 | 505 69 81-10 | £6.66 | £7.99 |
| .404" H64 | 505 69 81-15 | £6.66 | £7.99 |
| 1/4" H00 | 505 69 81-18 | £6.66 | £7.99 |
| 3/8" mini H36 | 505 24 37-01 | £6.66 | £7.99 |
| 3/8" mini pixel H38 | 579 55 88-01 | £6.66 | £7.99 |

COMBINATION GAUGES

Our combination gauges are specifically designed with a file gauge and depth gauge setter together in one tool. Use together with our round and flat files for a correct filing angle.



| Item | Order PNC | RRP ex VAT | RRP inc VAT |
|---------------------------------|--------------|------------|--------------|
| H00 1/4" | 580 68 74-01 | £8.33 | £9.99 |
| H30 .325" 1.3 mm Pixel | 505 69 81-08 | £8.33 | £9.99 |
| 325 X-CUT™ SP33G | 586 93 84-01 | £8.33 | £9.99 |
| 0.325" Mini X-CUT™ SP21G | 595 00 47-01 | £8.33 | £9.99 |
| H25 .325" 1.5 mm | 505 69 81-09 | £8.33 | £9.99 |
| H42 3/8" 1.5 mm Full chisel | 505 24 35-01 | £8.33 | £9.99 |
| 3/8" X-CUT™ C85 | 586 93 86-01 | £8.33 | £9.99 |
| H51/54/58 3/8" 1.5 mm | 575 99 15-01 | £8.33 | £9.99 |

FILE KITS

Complete filing kit with a file handle, combination gauge or a file gauge and depth gauge, two round files and one flat file.



| Item | Order PNC | RRP ex VAT | RRP inc VAT |
|----------------------------------|--------------|------------|---------------|
| 0.325" | 505 69 81-25 | £16.66 | £19.99 |
| 0.325" Pixel | 505 69 81-27 | £16.66 | £19.99 |
| 0.325" Pixel X-CUT™ SP33G | 586 93 34-01 | £16.66 | £19.99 |
| 0.325" Mini X-CUT™ SP21G | 595 00 46-01 | £16.66 | £19.99 |
| 0.404" | 505 69 81-92 | £16.66 | £19.99 |
| 3/8" X-CUT™ C85 | 586 93 85-01 | £16.66 | £19.99 |
| 1/4" H00 | 580 68 75-01 | £16.66 | £19.99 |
| 3/8" | 505 69 81-30 | £16.66 | £19.99 |
| 3/8" mini | 505 69 81-38 | £16.66 | £19.99 |
| 3/8" X-CUT™ S93G | 587 80 67-01 | £16.66 | £19.99 |
| 3/8" mini H37 | 579 65 36-01 | £16.66 | £19.99 |
| Clearing Saw Blade | 505 69 81-20 | £14.99 | £17.99 |

DEPTH GAUGES

Specifically designed file gauges that give the correct filing angles. Use together with our flat files.



| Item | Order PNC | RRP ex VAT | RRP inc VAT |
|-----------|--------------|------------|--------------|
| 3/8" | 505 69 81-01 | £3.33 | £3.99 |
| 3/8" mini | 505 69 81-03 | £3.33 | £3.99 |
| .325" | 505 69 81-00 | £3.33 | £3.99 |
| .404" | 505 69 81-02 | £3.33 | £3.99 |

STUMP VISE

To fasten the chainsaw in a secure position when filing. Made of forged steel.



| Order PNC | RRP ex VAT | RRP inc VAT |
|--------------|------------|---------------|
| 505 66 52-56 | £14.99 | £17.99 |

HUSQVARNA RECOMMEND

NEW

X-Guard Bio Chain Oil



Keep your chain lubricated with our NEW X-Guard Bio Chain Oil with improved formula giving superior lubrication performance even in extreme conditions. Excellent anti-oxidation properties protect the bar and chain during storage. Page 183



FORESTRY TOOLS



TOOL BELT FLEXI – CARRIER KIT



A flexible and ergonomic tool belt with excellent weight distribution and adjustable, one-hand-release belt buckle specially developed for forestry work. Intuitive and easy to personalise with easily attached holders, pockets and harness. Tool belt FLEXI. Harness. Accessory bag. File and combi-tool holder. Universal bag. Carrier hook. Wedge pocket.

| Order PNC | RRP ex VAT | RRP inc VAT |
|--------------|------------|----------------|
| 593 83 72-03 | £141.66 | £169.99 |

TOOL BELT FLEXI – COMBI KIT



A flexible and ergonomic tool belt with excellent weight distribution and adjustable, one-hand-release belt buckle specially developed for forestry work. Intuitive and easy to personalise with easily attached holders, pockets and harness. Tool belt FLEXI. Harness. Combi holster with wedge pocket. File and combi-tool holder. Universal bag. Universal tool holder. Combi holster.

| Order PNC | RRP ex VAT | RRP inc VAT |
|--------------|------------|----------------|
| 593 83 72-01 | £149.99 | £179.99 |

TOOL BELT FLEXI – WEDGE KIT



A flexible and ergonomic tool belt with excellent weight distribution and adjustable, one-hand-release belt buckle specially developed for forestry work. Intuitive and easy to personalise with easily attached holders, pockets and harness. Tool belt FLEXI. Harness. Wedge pocket. File and combi-tool holder. Universal bag. Universal tool holder. Combi holster with wedge pocket.

| Order PNC | RRP ex VAT | RRP inc VAT |
|--------------|------------|----------------|
| 593 83 72-02 | £149.99 | £179.99 |

ACCESSORIES



1. TOOL BELT FLEXI

A flexible and ergonomic tool belt with excellent weight distribution and adjustable, one-hand-release belt buckle.

593 83 74-01 £54.16 **£64.99**

2. HARNESS FOR TOOL BELT FLEXI

Ergonomic design together with a chest strap evens the weight over the shoulders.

593 83 76-01 £27.49 **£32.99**

3. COMBI HOLSTER

Combi holster for lifting tong or lifting hook plus eyelets for measuring tape.

593 83 83-01 £20.83 **£24.99**

4. COMBI HOLSTER WITH WEDGE POCKET

Combi holster for lifting tong or lifting hook plus a pocket for wedges.

593 83 83-02 £20.83 **£24.99**

5. WEDGE POCKET

Pocket for multiple wedges, with individual sections keeping wedges in place.

593 83 88-01 £23.33 **£27.99**

6. UNIVERSAL BAG

Universal bag for first aid kit, GPS tracker, power bar and other smaller items.

593 83 92-01 £23.33 **£27.99**

7. MEASURE HOLDER

Holder to keep measuring tape in place.

593 83 91-01 £6.66 **£7.99**



8. FILE AND COMBI-TOOL HOLDER

Holder for one round and one flat file, plus combi-tool. The holder effectively prevents broken or lost tools.

593 83 94-01 £20.83 **£24.99**

9. SPRAY CAN HOLDER

Holster for a spray can that makes sure it is securely kept in its place.

593 83 95-01 £8.33 **£9.99**

10. CARRIER HOOK

A multi-purpose hook for carrying various tools, water cans or other equipment.

593 83 96-01 £8.33 **£9.99**

11. UNIVERSAL TOOL HOLDER

Multi-purpose holder for carrying tools such as an axe, impact bar etc.

593 83 97-01 £8.33 **£9.99**

12. BREAKING BAR HOLSTER

The breaking bar holster from our classic tool belt can also be used with tool belt FLEXI.

505 69 32-92 £8.33 **£9.99**

13. CALIPER HOLSTER

The caliper holster from our classic tool belt can also be used with tool belt FLEXI.

505 69 32-04 £8.33 **£9.99**

14. CRAYON HOLDER WITH REEL

Holder for crayon with spring-loaded metal reel. Crayon holder for 12 mm crayons. Robust design with a metal reel that could be attached to the tool belt or harness.

593 83 98-01 £29.16 **£34.99**

593 97 55-01, graphite crayons 12 pcs

£10.83 **£12.99**

15. ACCESSORY BAG

Extra bag, suitable for your fire extinguisher, water bottle, extra clothing and more.

590 77 71-01 £8.33 **£9.99**

16. FIRST AID KIT

Includes first aid bandage, 9 plasters in various sizes, 2 wound swabs, 1 mirror, 1 cotton bud.

504 09 53-01 £10.83 **£12.99**

17. TAPE MEASURES

With release hook.

Metric 15m/50' 586 99 76-01 £41.66 **£49.99**

Metric 20m/66' 586 99 76-02 £45.83 **£54.99**

IMPACT BAR



Durable and robust impact bar with optimised grip and the front teeth give a better grip in wood.

| Order PNC | RRP ex VAT | RRP inc VAT |
|--------------|------------|---------------|
| 577 40 28-01 | £41.66 | £49.99 |

LONG BREAKING BAR



Features forged bottom parts for extra strength. Front teeth give a better grip and a long handle makes it possible for a two-hand grip.

| Item | Order PNC | RRP ex VAT | RRP inc VAT |
|-----------|--------------|------------|---------------|
| 130 cm | 574 38 72-01 | £83.33 | £99.99 |
| Cant Hook | 574 38 73-01 | £16.66 | £19.99 |

FOOT BREAKING BAR



Telescopic foot breaking bar. Can be carried in a holster on a belt.

| Order PNC | RRP ex VAT | RRP inc VAT |
|--------------|------------|---------------|
| 504 98 16-92 | £45.83 | £54.99 |

BREAKING BAR WITH CANT HOOK



Fully forged with plastic handle, repeat heel and turning hook.

| Item | Order PNC | RRP ex VAT | RRP inc VAT |
|-----------|--------------|------------|---------------|
| 80 cm | 586 89 69-01 | £54.16 | £64.99 |
| Cant Hook | 505 69 43-02 | £16.66 | £19.99 |



LIFTING TONGS



Features sharp hooks with ground edges. Special hardened steel with a treated surface makes them robust and less sensitive for rust.

| Item | Order PNC | RRP ex VAT | RRP inc VAT |
|-------|--------------|------------|---------------|
| 20 cm | 574 38 75-01 | £24.99 | £29.99 |
| 30 cm | 574 38 76-01 | £37.49 | £44.99 |

LIFTING HOOK



Features an extended hook for longer, wider opening to give a better grip when working. Special hardened steel with treated surface makes the hook robust and less sensitive to rust.

| Order PNC | RRP ex VAT | RRP inc VAT |
|--------------|------------|---------------|
| 574 38 74-01 | £19.16 | £22.99 |

MARKING TAPE



100% viscose, biodegradable. Approx. 75m long and 20mm wide.

| Item | Order PNC | RRP ex VAT | RRP inc VAT |
|--------|--------------|------------|--------------|
| Orange | 574 28 77-00 | £2.49 | £2.99 |
| Red | 574 28 77-01 | £2.49 | £2.99 |
| Blue | 574 28 77-02 | £2.49 | £2.99 |
| Yellow | 574 28 77-03 | £2.49 | £2.99 |

BARK SPADE



115 cm long with a 12 cm wide blade.

| Order PNC | RRP ex VAT | RRP inc VAT |
|--------------|------------|---------------|
| 575 57 23-01 | £37.49 | £44.99 |

COMPOSITE UNIVERSAL HATCHET H900



LENGTH 34 cm
WEIGHT 0.9 kg

Small hatchet for outdoor, trekking and garden activities.

| Order PNC | RRP ex VAT | RRP inc VAT |
|--------------|------------|---------------|
| 580 76 10-01 | £33.33 | £39.99 |

COMPOSITE UNIVERSAL AXE A1400



LENGTH 60 cm
WEIGHT 1.4 kg

Universal axe ideal for splitting resinous wood.

| Order PNC | RRP ex VAT | RRP inc VAT |
|--------------|------------|---------------|
| 580 76 11-01 | £45.83 | £54.99 |

COMPOSITE UNIVERSAL AXE A2400



LENGTH 70 cm
WEIGHT 2.4 kg

Powerful universal axe for different types of wood work.

| Order PNC | RRP ex VAT | RRP inc VAT |
|--------------|------------|---------------|
| 580 76 12-01 | £58.33 | £69.99 |

COMPOSITE SPLITTING AXE S1600



LENGTH 60 cm
WEIGHT 1.6 kg

Splitting axe for splitting logs and chunks of wood.

| Order PNC | RRP ex VAT | RRP inc VAT |
|--------------|------------|---------------|
| 580 76 13-01 | £49.99 | £59.99 |



COMPOSITE SPLITTING AXE S2800



LENGTH 70 cm
WEIGHT 2.8 kg

Powerful splitting axe for splitting large logs.

| Order PNC | RRP ex VAT | RRP inc VAT |
|--------------|------------|---------------|
| 580 76 14-01 | £62.49 | £74.99 |

WOODEN HATCHET



LENGTH 37.5 cm
WEIGHT 0.6 kg

A hatchet for fire wood and garden work.

| Order PNC | RRP ex VAT | RRP inc VAT |
|--------------|------------|---------------|
| 576 92 64-01 | £31.66 | £37.99 |



WOODEN HIKING HATCHET

NEW



LENGTH 24 cm
WEIGHT 0.5 kg

Smaller axe perfect for hiking and camping.

| Order PNC | RRP ex VAT | RRP inc VAT |
|--------------|------------|---------------|
| 599 67 35-01 | £54.16 | £64.99 |

WOODEN FOREST AXE



LENGTH 65 cm
WEIGHT 0.85 kg

Suitable for small-scale tree felling, limbing logs, branch trimming and clearing bushes. The long handle gives power to the cut.

| Order PNC | RRP ex VAT | RRP inc VAT |
|--------------|------------|---------------|
| 576 92 62-01 | £41.66 | £49.99 |

WOODEN CAMPING AXE



LENGTH 37.5 cm
WEIGHT 0.5 kg

A smaller axe ideal for outdoor life in forests and open land, suitable for most tasks like chopping wood for the campfire. The size is perfect for packing in your backpack.

| Order PNC | RRP ex VAT | RRP inc VAT |
|--------------|------------|---------------|
| 576 92 63-01 | £54.16 | £64.99 |

WOODEN CARPENTER'S AXE



LENGTH 50 cm
WEIGHT 1 kg

Best suited for carpentry and other wood work. Recess in the head so that the hand gets as close as possible to the cutting edge for maximum control.

| Order PNC | RRP ex VAT | RRP inc VAT |
|--------------|------------|---------------|
| 576 92 65-01 | £54.16 | £64.99 |

WOODEN SMALL SPLITTING AXE



LENGTH 50 cm
WEIGHT 0.9 kg

Best suited for basic splitting of lighter fire wood. The head is designed to go easy into the wood, and its small size makes it possible to use with one-hand grip.

| Order PNC | RRP ex VAT | RRP inc VAT |
|--------------|------------|---------------|
| 576 92 68-01 | £41.66 | £49.99 |

WOODEN LARGE SPLITTING AXE



LENGTH 75 cm
WEIGHT 1.5 kg

Best suited for splitting thicker wood and fire wood. The long handle creates extra power and has space for two-hand grip.

| Order PNC | RRP ex VAT | RRP inc VAT |
|--------------|------------|---------------|
| 576 92 67-01 | £62.49 | £74.99 |



FORESTRY AND ARBORIST TOOLS

WOODEN SLEDGE AXE



LENGTH 80 cm
WEIGHT 2.5 kg

The most powerful and heaviest axe made for splitting logs and large chunks of wood. It has a hardened striking face in the neck and can therefore be used as a sledge or in combination with a splitting wedge.

| Order PNC | RRP ex VAT | RRP inc VAT |
|--------------|------------|---------------|
| 576 92 66-01 | £70.83 | £84.99 |

WOODEN CLEARING AXE



LENGTH 67.5 cm
WEIGHT 1 kg

With hickory shaft and a double-edged blade that is reversible and replaceable.

| Order PNC | RRP ex VAT | RRP inc VAT |
|--------------|------------|---------------|
| 579 00 06-01 | £33.33 | £39.99 |

WOODEN HATCHET AXE



LENGTH 36 cm
WEIGHT 0.6 kg

High quality forged hatchet with ash wood handle for small firewood and forest tasks.

| Order PNC | RRP ex VAT | RRP inc VAT |
|--------------|------------|---------------|
| 597 62 77-01 | £23.33 | £27.99 |

WOODEN UNIVERSAL AXE



LENGTH 70 cm
WEIGHT 1.25 kg

High quality forged axe with ash wood handle and polished finish for low friction.

| Order PNC | RRP ex VAT | RRP inc VAT |
|--------------|------------|---------------|
| 597 62 90-01 | £37.49 | £44.99 |

WOODEN SMALL SPLITTING AXE

NEW



LENGTH 50 cm
WEIGHT 1.25 kg

High quality forged small splitting axe with ash wood handle for splitting small to medium logs.

| Order PNC | RRP ex VAT | RRP inc VAT |
|--------------|------------|---------------|
| 599 67 31-01 | £34.49 | £44.99 |

WOODEN LARGE SPLITTING AXE



LENGTH 80 cm
WEIGHT 2.5 kg

High quality forged splitting axe with ash wood handle for splitting large logs, ergonomic handle shape gives optimum grip.

| Order PNC | RRP ex VAT | RRP inc VAT |
|--------------|------------|---------------|
| 597 62 94-01 | £62.49 | £74.99 |

WOODEN SAPPIE



Short-handled sappie for moving logs. Polished metal head with sharply curved tip. Part of the wooden handle is painted in orange for improved visibility.

| Order PNC | RRP ex VAT | RRP inc VAT |
|----------------------|------------|---------------|
| 38 cm - 579 69 28-01 | £24.99 | £29.99 |
| 80 cm - 579 69 28-02 | £30.83 | £36.99 |

GRINDSTONE



Silicon carbide grindstone for sharpening axes. Course and fine grains. In leather case.

| Item | Order PNC | RRP ex VAT | RRP inc VAT |
|------------|--------------|------------|---------------|
| Grindstone | 599 67 46-01 | £23.33 | £27.99 |



FELLING WEDGES



Made of high impact ABS plastic. Helps the tree fall in the right direction.

| Item | Order PNC | RRP ex VAT | RRP inc VAT |
|---------------|--------------|------------|---------------|
| 10cm Arborist | 598 03 57-01 | £7.49 | £8.99 |
| 14 cm | 505 69 47-02 | £7.49 | £8.99 |
| 20 cm | 505 69 47-03 | £9.99 | £11.99 |
| 25cm | 505 69 47-04 | £10.83 | £12.99 |

ALUMINIUM FELLING WEDGE



Helps the tree fall in the right direction. Possible to re-grind.

| Item | Order PNC | RRP ex VAT | RRP inc VAT |
|--------------|--------------|------------|---------------|
| 550g, 22 cm | 586 88 59-01 | £16.66 | £19.99 |
| 1000g, 26 cm | 586 88 59-02 | £23.33 | £27.99 |



SPLITTING WEDGES



Both made in high quality steel. Twisted wedge can be used for heavier duty log splitting.

| Item | Order PNC | RRP ex VAT | RRP inc VAT |
|--------------------------|--------------|------------|---------------|
| Twisted Splitting Wedge | 577 25 92-01 | £24.99 | £29.99 |
| Straight Splitting Wedge | 578 45 68-01 | £24.99 | £29.99 |

CHAINSAW BOX



Tough handy carrying case designed to carry a chainsaw, lubricants, and other accessories.

| Order PNC | RRP ex VAT | RRP inc VAT |
|--------------|------------|---------------|
| 531 30 08-72 | £37.49 | £44.99 |

Dealer Information: Must be ordered in quantities of 4

CHAINSAW BAG



48 Litre. Especially made for your chainsaw. Extra pockets for the chainsaw files and a Velcro fastening pocket placed on the outside.

| Order PNC | RRP ex VAT | RRP inc VAT |
|--------------|------------|---------------|
| 597 41 83-01 | £33.33 | £39.99 |

DUFFEL BAG 70L



Moisture-repellent and easily cleaned material, smart inside pockets and soft top handles. Removable shoulder straps and organising bags included.

| Order PNC | RRP ex VAT | RRP inc VAT |
|--------------|------------|---------------|
| 593 25 83-01 | £62.49 | £74.99 |

TROLLEY BAG 90L



Robust trolley bag with easy access u-shaped zipper and silent rubber wheels. Moulded bottom and side make the bag stand upright without support. Two organizing bags included.

| Order PNC | RRP ex VAT | RRP inc VAT |
|--------------|------------|---------------|
| 593 25 81-01 | £83.33 | £99.99 |

BACKPACK



Durable backpack for all weathers. Easily cleaned material that keeps the inside dry. Roll-up seal and smart compartments for your laptop, thermos and water bottle.

| Order PNC | RRP ex VAT | RRP inc VAT |
|--------------|------------|---------------|
| 593 25 82-01 | £49.99 | £59.99 |



FUEL STORAGE



The Combi Can enables you to refuel quickly without splash effects and any waste. The two containers are designed to achieve an optimised fuel and chain oil ratio. It also features an integrated tool box for frequently needed spare parts and filing equipment.

Approved in accordance with UN recommendations.

COMBI CAN



| Item | Order PNC | RRP ex VAT | RRP inc VAT |
|-------------------------|--------------|------------|---------------|
| Combi Can 5 + 2.5 Litre | 580 75 42-01 | £33.33 | £39.99 |
| Fuel Spout | 586 11 04-01 | £14.16 | £16.99 |
| Oil Spout | 586 11 05-01 | £14.16 | £16.99 |
| Winter Oil Spout | 586 11 07-01 | £7.49 | £8.99 |

+ THE SMART COMBI CAN



LEVEL WINDOW

For quick visual check of remaining fuel level.



MECHANICAL LOCK

The spout has a mechanical lock to prevent unexpected opening and leakage.



INTEGRATED TOOL BOX

Making it easy to bring extra tools and frequent parts.



OVERFILL PROTECTION

The flow stops automatically when the machine's tank is full, which means you can lift the Combi Can without spilling fuel.



ERGONOMIC GRIP

The handles are placed for optimal lifting ergonomics when carrying and refuelling.



PARKING POSITION

The spouts can be rotated into a parking position to prevent damage during transportation.

HAND SAWS

The new generation of Husqvarna saws have been ergonomically designed, to lie comfortably and safely in your hand during sawing and a stop at the end of the handle prevents you from slipping. This has proven particularly useful during pulling movements, and assists you in making smooth progress.

FOLDABLE PRUNING SAW 200FO



With a total length of 47 cm, the 200FO saw is an easy-to-use all-rounder for cutting back thicker branches. It is lightweight making it ideal for all minor sawing work in the garden, and other outdoor activities.

| Order PNC | RRP ex VAT | RRP inc VAT |
|--------------|------------|---------------|
| 967 23 64-01 | £24.99 | £29.99 |

STRAIGHT PRUNING SAW 300ST



Total length of 40 cm. The rigid, straight saw blade with impulse-hardened precision toothing means you receive particularly high sawing performance, quiet running, effort-saving sawing and a very long lifetime. The particularly smooth pulling cut is ideal for fresh and dry wood. Comes with blade cover.

| Order PNC | RRP ex VAT | RRP inc VAT |
|--------------|------------|---------------|
| 967 23 65-01 | £24.99 | £29.99 |

CURVED PRUNING SAW 300CU



Total length of 40 cm. The rigid, curved saw blade with impulse-hardened precision toothing means you receive particularly high sawing performance, quiet running, effort-saving sawing and a very long lifetime. The particularly smooth pulling cut is ideal for fresh and dry wood. Comes with blade cover.

| Order PNC | RRP ex VAT | RRP inc VAT |
|--------------|------------|---------------|
| 967 23 66-01 | £29.16 | £34.99 |



PROFESSIONAL ARBORIST ACCESSORIES

THROW WEIGHT



Constructed from 100% 1000 denier Cordura fabric. Abrasion resistant. Improved durability with high tensile strength.

| Item | Order PNC | RRP ex VAT | RRP inc VAT |
|---------------|--------------|------------|---------------|
| 14 oz / 397 g | 596 93 58-11 | £14.99 | £17.99 |
| 12 oz / 340 g | 596 93 58-12 | £14.99 | £17.99 |
| 10 oz / 284 g | 596 93 58-13 | £14.99 | £17.99 |
| 8 oz / 227 g | 596 93 58-14 | £14.99 | £17.99 |

FOLDING THROWLINE CUBE



Large 40 cm / 16" cube construction. Easily folds down to 20 cm / 8" x 40 cm / 16" triangle. 2 Interior pockets keeps throw weights separate.

| Order PNC | RRP ex VAT | RRP inc VAT |
|--------------|------------|---------------|
| 596 93 60-11 | £45.83 | £54.99 |

ROPE BAG



28L capacity bag holds up to 76 m / 250' of 12.7 mm / 1/2" diameter rope. Cinch top closure. External daisy chains. External gear storage. Covered top handles for added comfort.

| Order PNC | RRP ex VAT | RRP inc VAT |
|--------------|------------|---------------|
| 596 93 63-11 | £37.49 | £44.99 |

CHAINSAW HOOK



For easy connection of a chainsaw to a harness. Robust connection. Optimised for T525 / T540 XP® / T536Li XP® / T535i XP® / T540i XP®.

| Order PNC | RRP ex VAT | RRP inc VAT |
|--------------|------------|---------------|
| 580 80 03-01 | £10.83 | £12.99 |

CARABINERS



Double locking twist lock gate. Key lock gate nose limits snagging of rope and clothing. Constructed from hot forged 707 aluminium.

| Item | Order PNC | RRP ex VAT | RRP inc VAT |
|------|--------------|------------|---------------|
| Oval | 596 93 62-11 | £15.83 | £18.99 |
| D' | 596 93 62-12 | £15.83 | £18.99 |
| HMS | 596 93 62-13 | £15.83 | £18.99 |

THROWLINE



55 m / 180' Throwline, 175mm diameter. 254 kg / 560 lb. tensile strength. Dyneema® construction. Low Stretch. Urethane coating for abrasion resistance. Hi-Vis orange.

| Order PNC | RRP ex VAT | RRP inc VAT |
|--------------|------------|---------------|
| 596 93 59-11 | £29.16 | £34.99 |

CHAINSAW STROP



To be used together with a chainsaw hook for connecting the chainsaw to a belt. Elastic design. Measures 0.5m when relaxed and 1.25m fully stretched out.

| Order PNC | RRP ex VAT | RRP inc VAT |
|--------------|------------|---------------|
| 577 43 80-01 | £19.16 | £22.99 |

CHAINSAW EYELET



For arborists who use a standard chainsaw. Offers a safe way to connect the chainsaw to the chainsaw strop. Has an overload release.

| Order PNC | RRP ex VAT | RRP inc VAT |
|--------------|------------|---------------|
| 578 07 71-01 | £9.99 | £11.99 |

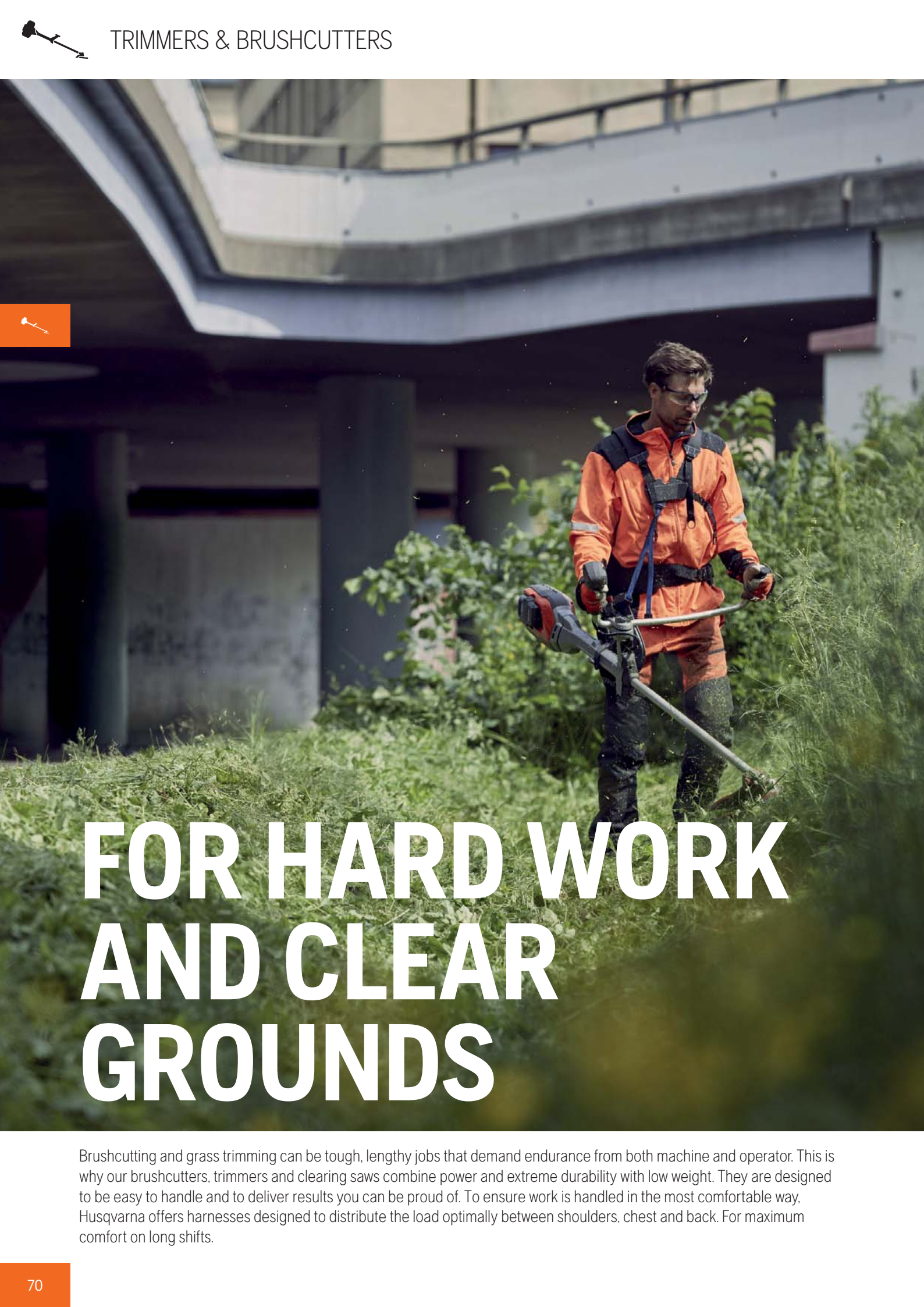

FOR HARD WORK AND CLEAR GROUNDS

Brushcutting and grass trimming can be tough, lengthy jobs that demand endurance from both machine and operator. This is why our brushcutters, trimmers and clearing saws combine power and extreme durability with low weight. They are designed to be easy to handle and to deliver results you can be proud of. To ensure work is handled in the most comfortable way, Husqvarna offers harnesses designed to distribute the load optimally between shoulders, chest and back. For maximum comfort on long shifts.



WHAT YOU GET AND HOW WE DO IT

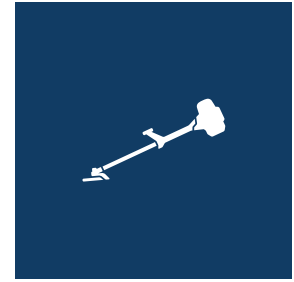

RAW POWER

The X-Torq® technology reduces harmful exhaust emissions and increases fuel efficiency, making work more comfortable and more economical.*



EASY TO START, EASY TO WORK WITH

For both petrol and battery-powered products a quick, easy start is imperative and we've made sure to develop technology to meet these demands. Just push a button or pull a cord: it's as easy as it should be.



ROBUST DESIGN

Our professional range of trimmers, brushcutters and forestry clearing saws are powerful, industrious machines, designed for many years of demanding operation.



BALANCED DESIGN

The handles are designed to be adjustable and vibration-dampened. High handle bars also make working on slopes more efficient.



LONG OPERATING

Low Vib® – engines are equipped with very effective anti-vibration dampeners that absorb vibrations, sparing your arms and hands to let you work more comfortably during long shifts.











* Compared with equivalent models without this feature.



PRODUCT USE GUIDE

Use this guide to help you select the best product for your needs.

| TYPE OF USE | MODEL | POWER SOURCE | DISPLACEMENT (CM ³) / VOLTAGE | WEIGHT | HANDLE TYPE |  |  | |
|---|---------------|---|---|---------|-------------|---|---|--|
| | | | | | | GRASS BLADE (SUPPLIED) | GRASS | |
|  FULL-TIME USE (PROFESSIONAL) | 520iLX |  | 36V Li-ion | 3.0 kg* | Loop | | ● | |
| | 520iRX |  | 36V Li-ion | 3.8 kg* | Bullhorn | ● | ● | |
| | 525RJX | Petrol | 25.4 cm ³ | 4.3 kg | J-handle | ● | ● | |
| | 525LK - Combi | Petrol | 25.4 cm ³ | 4.5 kg | Loop | | ● | |
| | 525RX | Petrol | 25.4 cm ³ | 4.9 kg | Bulhorn | ● | ● | |
| | 525RXT | Petrol | 25.4 cm ³ | 5.2 kg | Bulhorn | ● | ● | |
| | 535LK - Combi | Petrol | 34.6 cm ³ | 5.8 kg | Loop | | ● | |
| | 535RXT | Petrol | 34.6 cm ³ | 6.7 kg | Bullhorn | ● | ○ | |
| | 535iRX |  | 36V Li-ion | 4.9 kg* | Bullhorn | ● | ● | |
| | 535iRXT |  | 36V Li-ion | 4.9 kg* | Bullhorn | ● | ● | |
| | 535iFR |  | 36V Li-ion | 4.5 kg* | Bullhorn | ● *** | ● | |
| | 543RS | Petrol | 40.1 cm ³ | 7.4 kg | Bullhorn | ● | | |
| | 545RX | Petrol | 45.7 cm ³ | 8.9 kg | Bullhorn | ● | | |
| | 545RXT | Petrol | 45.7 cm ³ | 8.7 kg | Bullhorn | ● | | |
| | 555RXT | Petrol | 53.3 cm ³ | 9.2 kg | Bullhorn | ● | | |
| 553RBX | Petrol | 50.7 cm ³ | 12.1 kg | Loop | ● | | | |

The product selector is only to be used as a guide. Please visit your local Authorised Husqvarna dealer for more information.

*Excludes battery **Requires saw blade *** Supplied with saw blade ● Optimised solution (guideline only) ○ Capable solution but not optimal (guideline only)



| TRIMMING AND BRUSHCUTTING | | | | | MULTI-TOOL ATTACHMENTS | | | | | PAGE |
|---------------------------|-------------------|------------------|-------------------------|--------|------------------------|---------------|--------|------|----|------|
| LIGHT VEGETATION | MEDIUM VEGETATION | HEAVY VEGETATION | BRUSHWOOD / SMALL TREES | HEDGES | PRUNING | HARD SURFACES | LEAVES | SOIL | | |
| ● | ○ | | | | | | | | 74 | |
| ● | ○ | | | | | | | | 74 | |
| ● | ○ | | | | | | | | 75 | |
| ● | ○ | | | ● | ● | ● | ● | ● | 87 | |
| ● | ○ | | | | | | | | 75 | |
| ● | ○ | | | | | | | | 75 | |
| ● | ● | ○ | | ● | ● | ● | ● | ● | 87 | |
| ● | ● | ○ | | | | | | | 75 | |
| ● | ● | ○ | | | | | | | 76 | |
| ● | ● | ○ | | | | | | | 76 | |
| ● | ● | ○ | ● | | | | | | 77 | |
| ○ | ● | ● | | | | | | | 78 | |
| ○ | ● | ● | ●** | | | | | | 78 | |
| ○ | ● | ● | ●** | | | | | | 78 | |
| | ○ | ● | ●** | | | | | | 79 | |
| | ● | ● | | | | | | | 79 | |





TRIMMERS & BRUSHCUTTERS



High performance petrol and battery brushcutters designed for full-time professional use in light to medium density applications. A choice of both loop and bullhorn handles to suit a range of different applications. Bullhorn machines feature high offset post and ergonomic harness for optimum working position which maximises user comfort and productivity, ideal when working for long periods. Products are supplied with a highly efficient line head and grass blade.

Ideal for applications including:

- Landscape maintenance
- Verges and pathways
- Parks and public spaces
- Overgrown areas
- Noise sensitive areas (battery)

520iLX



Professional use battery loop handle trimmer with 2-way rotation trimmer head.

- Brushless motor
- Two way head rotation
- Blade capable
- Keypad with savE™
- T25B Tap'n'Go head
- Weatherproof (IPX4)

| Voltage | Motor type | Vibration levels F/R | Weight |
|-------------------------------------|----------------|----------------------------|------------------------|
| 36V Li-ion | BLDC Brushless | 1.2 / 0.7 m/s ² | 3.0 kg (excl. battery) |
| Model | Order PNC | RRP ex VAT | RRP inc VAT |
| 520iLX Unit only | 967 91 61-11 | £274.17 | £329.00 |
| Unit + BLi200 & QC330 (recommended) | | £539.99 | £647.99 |

520iRX



Professional use battery bullhorn trimmer with 2-way rotation trimmer head. Supplied with grass blade.

- Brushless motor
- Two way head rotation
- T25B head & grass blade
- Keypad with savE™
- Balance 35B harness
- Weatherproof (IPX4)

| Voltage | Motor type | Vibration levels F/R | Weight |
|-------------------------------------|----------------|----------------------------|------------------------|
| 36V Li-ion | BLDC Brushless | 1.2 / 0.7 m/s ² | 3.8 kg (excl. battery) |
| Model | Order PNC | RRP ex VAT | RRP inc VAT |
| 520iRX Unit only | 967 91 62-02 | £290.83 | £349.00 |
| Unit + BLi200 & QC330 (recommended) | | £556.66 | £667.99 |

WORKING TIME ON ONE CHARGE

520iLX / 520iRX

LIGHT

TOUGH



| | | | |
|--|----------------|------------|------------|
| | BLi100 | 40 min | 20 min |
| | BLi200 | 1 h 20 min | 40 min |
| | BLi300 | 2 h 15 min | 1 h 15 min |
| | BLi550X | 4 h 15 min | 2 h |
| | BLi950X | 8 h 15 min | 4 h 15 min |



525RJX



J-Handle brushcutter designed for intensive professional use in lighter applications. Lowest vibrations in class.

- X-Torq®
- Single harness
- Grass blade
- Smart Start®
- T35 Tap'n'Go head

| Displacement | Power output | Vibration levels F/R | Weight |
|----------------------|----------------|---------------------------|----------------|
| 25.4 cm ³ | 1.0kW / 1.3 hp | 21 / 1.9 m/s ² | 4.3 kg |
| Model | Order PNC | RRP ex VAT | RRP inc VAT |
| 525RJX | 966 77 71-01 | £ 315.83 | £379.00 |

535RXT



High performance mid-range bullhorn brushcutter for intensive professional use in medium applications.

- X-Torq®
- Smart Start®
- T35 Tap'n'Go head
- Low Vib®
- Balance X™ harness
- Grass blade

| Displacement | Power output | Vibration levels F/R | Weight |
|----------------------|----------------|---------------------------|----------------|
| 34.6 cm ³ | 1.6kW / 2.2 hp | 2.4 / 31 m/s ² | 6.7 kg |
| Model | Order PNC | RRP ex VAT | RRP inc VAT |
| 535RXT | 966 62 89-01 | £582.50 | £699.00 |

525RX



Low weight bullhorn brushcutter designed for intensive professional use in lighter applications.

- X-Torq®
- Balance 35 harness
- Grass blade
- Smart Start®
- T35 Tap'n'Go head

| Displacement | Power output | Vibration levels F/R | Weight |
|----------------------|----------------|---------------------------|----------------|
| 25.4 cm ³ | 1.0kW / 1.3 hp | 21 / 2.3 m/s ² | 4.9 kg |
| Model | Order PNC | RRP ex VAT | RRP inc VAT |
| 525RX | 966 77 68-01 | £ 349.17 | £419.00 |

525RXT



Ultra low vibration bullhorn brushcutter designed for intensive professional use in lighter applications.

- X-Torq®
- Smart Start®
- T35 Tap'n'Go head
- Low Vib®
- Balance 55 harness
- Grass blade

| Displacement | Power output | Vibration levels F/R | Weight |
|----------------------|----------------|----------------------------|----------------|
| 25.4 cm ³ | 1.0kW / 1.3 hp | 1.8 / 1.9 m/s ² | 5.2 kg |
| Model | Order PNC | RRP ex VAT | RRP inc VAT |
| 525RXT | 966 77 69-01 | £ 399.17 | £479.00 |

REPLACEMENT CUTTING EQUIPMENT

| Model | 520iLX / iRX | 525RJX / RX / RXT | 535RXT |
|---------|---------------|-------------------|---------------|
| Head | T25B M10 | T35 M10 | T35 M12 |
| PNC | 579 29 40-03 | 578 44 63-01 | 578 44 64-01 |
| Ex VAT | £12.49 | £14.99 | £14.99 |
| Inc VAT | £14.99 | £17.99 | £17.99 |

| Recommended line size | | | |
|-----------------------|---------------|---------------|---------------|
| Line Diameter | 2.0 - 2.4 mm | 2.4 - 2.7 mm | 2.4 - 2.7 mm |
| Grass Blade | Multi 255-3 | Grass 255-4 | Multi 300-3 |
| PNC | 578 44 49-01 | 578 44 37-01 | 578 44 45-01 |
| Ex VAT | £14.16 | £14.16 | £16.66 |
| Inc VAT | £16.99 | £16.99 | £19.99 |

| Guard type | Combi guard | Combi guard | Combi guard |
|------------|---------------|---------------|---------------|
| PNC | 577 01 83-03 | 588 11 79-01 | 537 33 16-01 |
| Ex VAT | £23.33 | £21.66 | £31.66 |
| Inc VAT | £27.99 | £25.99 | £37.99 |

| Support Cup | N/A | Support cup | Support cup M12 |
|-------------|------------|--------------|-----------------|
| PNC | N/A | 503 89 01-01 | 503 89 01-02 |
| Ex VAT | N/A | £6.66 | £6.66 |
| Inc VAT | N/A | £7.99 | £7.99 |

| J- Handle Kit* | 520iLX | N/A | N/A |
|----------------|---------------|------------|------------|
| PNC | 587 37 50-01 | N/A | N/A |
| Ex VAT | £20.83 | N/A | N/A |
| Inc VAT | £24.99 | N/A | N/A |

*Required when using grass blade.

HUSQVARNA RECOMMEND

Opti Quadra and Opti Penta trimmer lines for a heavier duty line. Page 92

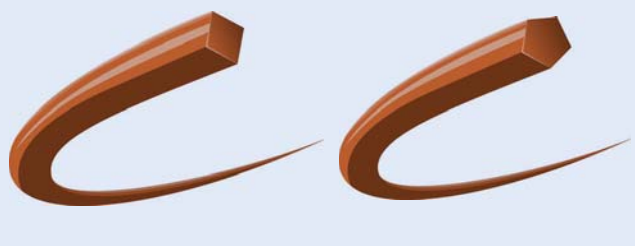



BRUSHCUTTERS



High performance battery brushcutters designed for full-time professional use in light to medium density applications. Bullhorn machines with high offset post and ergonomic harness for optimum working position which maximises user comfort and productivity, ideal when working for long periods. Products are supplied with a highly efficient line head and grass blade.

Ideal for applications including:

- **Landscape maintenance**
- **Verges and pathways**
- **Parks and public spaces**
- **Overgrown areas**
- **Noise sensitive areas**

535iRXT



High-performance battery bull horn brushcutter designed for professional use in medium applications. 35 cm³ petrol equivalent performance.

- Fleet Services™ ready
- ErgoFeed auto line feed
- Integrated or backpack batteries
- ErgoFeed head and grass blade
- Low Vib®
- Magnesium chassis
- Weatherproof (IPX4)
- Balance XB™ Harness

535iRX



High-performance battery bull horn brushcutter designed for professional use in medium applications. 35 cm³ petrol equivalent performance.

- Low Vib®
- Balance 55 harness
- Weatherproof (IPX4)
- Intuitive keypad
- 45cm cutting swath

| Voltage | Motor type | Vibration levels F/R | Weight |
|-------------------------------------|----------------|----------------------------|------------------------|
| 36V Li-ion | BLDC Brushless | 1.3 / 1.4 m/s ² | 4.9 kg (excl. battery) |
| Model | Order PNC | RRP ex VAT | RRP inc VAT |
| 535iRX Unit only | 967 85 06-03 | £432.50 | £519.00 |
| Unit + BLi300 & QC500 (recommended) | | £798.33 | £957.99 |

| WORKING TIME ON ONE CHARGE | 535iRX / 535iRXT | |
|----------------------------|------------------|-------|
| | LINE | BLADE |



| | | | |
|--|----------------|------------|------------|
| | BLi200 | 15 min | 25 min |
| | BLi300 | 30 min | 45 min |
| | BLi550X | 50 min | 1 h 5 min |
| | BLi950X | 1 h 50 min | 2 h 25 min |



Li-ion 36V



Intuitive key pad is equipped with power button, LED battery status indicator as well as 3 speed mode for the E-TORO™ motor. ErgoFeed™ button is positioned close to the thumb for convenience.



ErgoFeed™ function feeds trimmer line with a simple push of a button. Reducing risk of unintentional feed, minimising trimmer line consumption. Trimmer head is designed with minimum moving parts for robust and durability.

| Voltage | Motor Type | Vibration Levels F/R | Weight |
|-------------------------------------|----------------|----------------------------|------------------------|
| 36V Li-ion | BLDC Brushless | 1.2 / 1.4 m/s ² | 4.9 kg (excl. battery) |
| Model | Order PNC | RRP Ex VAT | RRP Inc VAT |
| 535iRXT Unit only | 967 85 06-01 | £ 499.17 | £599.00 |
| Unit + BLi300 & QC500 (recommended) | | £ 864.99 | £1,037.99 |

REPLACEMENT CUTTING EQUIPMENT

| Model | 535iRX | 535iRXT |
|-------------|----------------|-----------------------|
| Head | T35 M12 | E35B ErgoFeed™ |
| PNC | 578 44 64-01 | 594 72 70-01 |
| Ex VAT | £14.99 | £17.49 |
| Inc VAT | £17.99 | £20.99 |

Recommended line size

| Line Diameter | 2.4 - 2.7 mm | 2.4 - 2.7 mm |
|---------------|--------------|--------------|
|---------------|--------------|--------------|

| Grass Blade | Multi 300-3 | Multi 300-3 |
|-------------|---------------|---------------|
| PNC | 578 44 45-01 | 578 44 45-01 |
| Ex VAT | £16.66 | £16.66 |
| Inc VAT | £19.99 | £19.99 |

| Guard type | Combi guard | Combi guard |
|------------|---------------|---------------|
| PNC | 590 88 01-01 | 590 88 01-01 |
| Ex VAT | £19.16 | £19.16 |
| Inc VAT | £22.99 | £22.99 |

| Support Cup | Support cup M12 | Support cup M12 |
|-------------|-----------------|-----------------|
| PNC | 503 89 01-02 | 503 89 01-02 |
| Ex VAT | £6.66 | £6.66 |
| Inc VAT | £7.99 | £7.99 |

535iFR

Li-ion 36V



High-performance battery clearing saw designed for lighter forestry clearing applications. 35 cm³ petrol equivalent performance.

- Fleet Services™ ready
- Saw & grass blades
- 45cm cutting swath
- Intuitive keypad
- Balance 55 harness
- Weatherproof (IPX4)

| Voltage | Motor type | Vibration Levels F/R | Weight |
|-------------------------------------|----------------|----------------------------|------------------------|
| 36V Li-ion | BLDC Brushless | 1.4 / 1.7 m/s ² | 4.5 kg (excl. battery) |
| Model | Order PNC | RRP ex VAT | RRP inc VAT |
| 535iFR Unit only | 967 85 05-01 | £ 457.50 | £549.00 |
| Unit + BLi300 & QC500 (recommended) | | £ 823.33 | £987.99 |

| Model | 535iFR |
|------------------|---------------|
| Saw Blade | |
| PNC | 597 46 82-01 |
| Ex VAT | £13.33 |
| Inc VAT | £15.99 |

| Grass Blade | Multi 300-3 |
|-------------|---------------|
| PNC | 578 44 45-01 |
| Ex VAT | £16.66 |
| Inc VAT | £19.99 |

| Trimmer Head | T35 M12 |
|--------------|---------------|
| PNC | 578 44 64-01 |
| Ex VAT | £14.99 |
| Inc VAT | £17.99 |

| Support Cup | Support cup M12 |
|-------------|-----------------|
| PNC | 503 89 01-02 |
| Ex VAT | £6.66 |
| Inc VAT | £7.99 |

WORKING TIME ON ONE CHARGE

**535iFR
SAW BLADE**



| | | |
|--|----------------|------------|
| | BLi200 | 30 min |
| | BLi300 | 1 h |
| | BLi550X | 1 h 35 min |
| | BLi950X | 3 h 20 min |

HUSQVARNA RECOMMEND

Technical Brushcutter and Trimmer clothing.
Page 172





BRUSHCUTTERS



High performance petrol brushcutters designed for full-time professional use in heavy density applications. Machines feature high offset post and ergonomic harness for optimum working position which maximises user comfort and productivity, ideal when working for long periods. Products are supplied with a highly efficient line head and grass blade. Selected machines with the addition of a saw blade can be used for brushwood and forestry applications.

Ideal for applications including:

- **Landscape maintenance**
- **Highways and pathways**
- **Parks and public spaces**
- **Overgrown areas**
- **Forestry clearing**

543RS



Heavy duty bullhorn brushcutter designed for intensive landscaper and landowner use.

- X-Torq®
- T35 Tap'n'Go head
- Double harness
- Grass blade

| Displacement | Power output | Vibration levels F/R | Weight |
|----------------------|--------------|----------------------------|----------------|
| 40.1 cm ³ | 15kW / 20 hp | 3.5 / 3.0 m/s ² | 7.4 kg |
| Model | Order PNC | RRP ex VAT | RRP inc VAT |
| 543RS | 966 77 99-01 | £499.17 | £599.00 |

545RX



High performance professional brushcutter designed for heavy duty applications. Can be used as a forestry clearing saw.

- X-Torq®
- Smart Start®
- T45X Tap'n'Go head
- Low Vib®
- Balance X™ harness
- Grass blade

| Displacement | Power output | Vibration levels F/R | Weight |
|----------------------|--------------|----------------------------|----------------|
| 45.7 cm ³ | 21kW / 28 hp | 3.2 / 2.9 m/s ² | 8.9 kg |
| Model | Order PNC | RRP ex VAT | RRP inc VAT |
| 545RX | 966 01 59-01 | £690.83 | £829.00 |

545RXT



High performance professional brushcutter with Autotune™ designed for heavy duty applications. Can be used as a forestry clearing saw.

- X-Torq®
- Autotune™ & chokeless start
- T45X Tap'n'Go head
- Low Vib®
- Balance XT™ harness
- Grass blade

| Displacement | Power output | Vibration levels F/R | Weight |
|----------------------|--------------|----------------------------|----------------|
| 45.7 cm ³ | 21kW / 28 hp | 3.2 / 2.9 m/s ² | 8.7 kg |
| Model | Order PNC | RRP ex VAT | RRP inc VAT |
| 545RXT | 967 17 67-01 | £749.17 | £899.00 |



555RXT



Our most powerful professional brushcutter designed for the most heavy duty applications. Can be used as a forestry clearing saw.

- X-Torq®
- Smart Start®
- T55X Tap'n'Go head
- Low Vib®
- Balance XT™ harness
- Grass blade

| Displacement | Power output | Vibration levels F/R | Weight |
|----------------------|-----------------|----------------------------|----------------|
| 53.3 cm ³ | 2.8kW / 3.75 hp | 1.5 / 1.6 m/s ² | 9.2 kg |
| Model | Order PNC | RRP ex VAT | RRP inc VAT |
| 555RXT | 966 62 90-01 | £832.50 | £999.00 |

553RBX



Powerful professional backpack brushcutter designed for heavy duty applications in demanding work environments.

- X-Torq®
- T45X Tap'n'Go head
- Backpack harness
- Grass blade

| Displacement | Power output | Vibration levels F/R | Weight |
|----------------------|----------------|----------------------------|----------------|
| 50.6 cm ³ | 2.3kW / 3.1 hp | 2.7 / 3.8 m/s ² | 12.1 kg |
| Model | Order PNC | RRP ex VAT | RRP inc VAT |
| 553RBX | 966 78 02-01 | £749.17 | £899.00 |

REPLACEMENT CUTTING EQUIPMENT

| Model | 543RS | 545RX | 545RXT |
|---------|---------------|---------------|---------------|
| Head | T35 M12 | T45X M12 | T45X M12 |
| PNC | 578 44 64-01 | 578 44 68-01 | 578 44 68-01 |
| Ex VAT | £14.99 | £27.49 | £27.49 |
| Inc VAT | £17.99 | £32.99 | £32.99 |

Recommended line size

| Line Diameter | 2.4 - 2.7 mm | 2.7 - 3.3 mm | 2.7 - 3.3 mm |
|---------------|--------------|--------------|--------------|
|---------------|--------------|--------------|--------------|

| Grass Blade | Multi 275-4 | Multi 300-3 | Multi 300-3 |
|-------------|---------------|---------------|---------------|
| PNC | 578 44 47-01 | 578 44 45-01 | 578 44 45-01 |
| Ex VAT | £15.83 | £16.66 | £16.66 |
| Inc VAT | £18.99 | £19.99 | £19.99 |

| Guard type | Combi guard | Combi guard | Combi guard |
|------------|---------------|---------------|---------------|
| PNC | 537 33 16-01 | 544 46 43-01 | 544 46 43-01 |
| Ex VAT | £31.66 | £29.16 | £29.16 |
| Inc VAT | £37.99 | £34.99 | £34.99 |

| Support Cup | Support cup M12 | Support cup M12 | Support cup M12 |
|-------------|-----------------|-----------------|-----------------|
| PNC | 503 89 01-02 | 502 15 70-02 | 502 15 70-02 |
| Ex VAT | £6.66 | £16.66 | £16.66 |
| Inc VAT | £7.99 | £19.99 | £19.99 |

| Model | 555RXT | 553RBX |
|---------|---------------|---------------|
| Head | T55X M12 | T45X M12 |
| PNC | 578 44 70-01 | 578 44 68-01 |
| Ex VAT | £33.33 | £27.49 |
| Inc VAT | £39.99 | £32.99 |

Recommended line size

| Line Diameter | 3.0 - 4.0 mm | 2.7 - 3.3 mm |
|---------------|--------------|--------------|
|---------------|--------------|--------------|

| Grass Blade | Multi 350-3 | Multi 275-4 |
|-------------|---------------|---------------|
| PNC | 578 44 44-01 | 578 44 47-01 |
| Ex VAT | £25.83 | £15.83 |
| Inc VAT | £30.99 | £18.99 |

| Guard type | Line guard | Blade guard | Combi guard |
|------------|---------------|---------------|---------------|
| PNC | 544 10 74-02 | 502 46 49-01 | 537 33 16-01 |
| Ex VAT | £23.33 | £33.33 | £31.66 |
| Inc VAT | £27.99 | £39.99 | £37.99 |

| Support Cup | Support cup M12 | Support cup M12 |
|-------------|-----------------|-----------------|
| PNC | 502 15 70-02 | 503 89 01-02 |
| Ex VAT | £16.66 | £6.66 |
| Inc VAT | £19.99 | £7.99 |

HUSQVARNA RECOMMEND

Technical Brushcutter and Trimmer clothing.
Page 172





HARNESSES



Ergonomically designed harnesses for optimised load distribution. Our harnesses effectively distribute the weight of the machine, for the best possible balance. This makes the machine feel lighter, easier to manoeuvre and less strenuous to operate.

Ideal for applications including:

- **Brushcutters**
- **Pole products**
- **Battery products**

BALANCE 35



Ergonomically designed harness that distributes the load optimally between your shoulders, chest and back. Designed for use with smaller brush cutters.

| | | |
|--------------|------------|---------------|
| Order PNC | RRP ex VAT | RRP inc VAT |
| 537 27 57-02 | £45.83 | £54.99 |

BALANCE 35B



Ergonomically designed harness specially developed for battery products. Distributes the weight of the machine optimally between your shoulders, chest and back.

| | | |
|--------------|------------|---------------|
| Order PNC | RRP ex VAT | RRP inc VAT |
| 537 27 57-05 | £45.83 | £54.99 |

+ SMART ERGONOMIC SOLUTIONS (BALANCE XT™)



Flexible shoulder section and individual height adjustment.



Weight distribution from shoulders to hips.



Unisex setting for over and under the chest.



Shock-absorbing, traveling hip pad.



BALANCE 55



Ergonomically designed harness that distributes the load optimally between your shoulders, chest and back. Designed for use with smaller brush cutters.

| Order PNC | RRP ex VAT | RRP inc VAT |
|--------------|------------|---------------|
| 537 27 57-01 | £49.99 | £59.99 |

BALANCE X™ / XB™



Advanced harness with outstanding weight distribution between the shoulders, chest and back. Features floating hip pad with quick release. Designed for use with larger brush cutters.

Balance XB™ is equipped with a holder for a battery carrier so you can bring an extra battery.

| Order PNC | RRP ex VAT | RRP inc VAT |
|-------------------|------------|---------------|
| 578 44 97-01 (X) | £74.99 | £89.99 |
| 597 46 93-01 (XB) | £74.99 | £89.99 |

BALANCE XT™



Our most advanced harness with unique features including male and female setting and pivoting shoulder section. Weight is evenly distributed across the upper body for maximum comfort and efficiency.

| Order PNC | RRP ex VAT | RRP inc VAT |
|--------------|------------|----------------|
| 578 44 98-01 | £91.66 | £109.99 |

| | BALANCE 35 | BALANCE 35B | BALANCE 55 | BALANCE X™ / XB™ | BALANCE XT™ |
|------------------------------|------------|-------------|------------|------------------|-------------|
| Wide, ventilated back plate | ● | ● | ● | ● | ● |
| Quick set adjustment points | ● | ● | ● | ● | ● |
| Padded, ergonomics straps | ● | ● | ● | ● | ● |
| Shock-absorbing hip pad | — | — | ● | ● | ● |
| Flexible hip pad suspension | ● | ● | ● | ● | ● |
| Wide, supporting hip belt | — | — | — | ● | ● |
| Quick release on hip pad | — | — | — | ● | ● |
| Grass and forest mode | — | — | — | ● | ● |
| Height adjustable back plate | — | — | — | — | ● |
| Flexible shoulder section | — | — | — | — | ● |
| Special setting for women | — | — | — | — | ● |

● = Available — = Not available



TECHNICAL SPECIFICATIONS

| TRIMMERS & BRUSHCUTTERS | 525RJX | 525RX | 525RXT | 535RXT | 543RS |
|--|---------|---------|---------|---------|---------|
| TECHNICAL SPECIFICATIONS | | | | | |
| Cylinder displacement, cm ³ | 25.4 | 25.4 | 25.4 | 34.6 | 40.1 |
| Power output, kW | 1.0 | 1.0 | 1.0 | 1.6 | 1.5 |
| Fuel tank, litres | 0.51 | 0.51 | 0.51 | 0.6 | 0.75 |
| Sound pressure level at operators ear, dB(A)* | 94 | 93 | 94 | 96 | 95 |
| Sound power level guaranteed (LWA) dB(A)** | 106 | 106 | 106 | 113 | 118 |
| Equivalent vibration level (ahv, eq) left/right handle, m/s ² *** | — | 2.1/2.3 | 1.8/1.9 | 2.4/3.1 | 3.5/3.0 |
| Equivalent vibration level (ahv, eq) front/rear handle, m/s ² *** | 2.1/1.9 | — | — | — | — |
| Weight (excl. cutting equipment), kg | 4.3 | 4.9 | 5.2 | 6.7 | 7.4 |
| FEATURES | | | | | |
| Autotune™ | — | — | — | — | — |
| Auto-return stop switch | ● | ● | ● | ● | ● |
| Combi-guard | ● | ● | ● | ● | ● |
| Ergonomic handle | — | ● | ● | ● | — |
| Fuel pump | ● | ● | ● | ● | ● |
| Grass bevel gear | ● | ● | ● | ● | ● |
| High handlebar | — | ● | ● | ● | — |
| Low Vib® | — | — | ● | ● | — |
| Smart Start® | ● | ● | ● | — | ● |
| Soft grip handles | — | — | ● | ● | — |
| Standalone starter | ● | ● | ● | ● | ● |
| Tap-n-Go trimmer head | ● | ● | ● | ● | ● |
| Tool-less adjustment harness hook eyelet | — | — | ● | ● | — |
| Tool-less adjustment of handlebar | — | ● | ● | ● | — |
| X-Torq® engine | ● | ● | ● | ● | ● |
| 7° offset handle bar | — | ● | ● | ● | — |
| HARNESSES | | | | | |
| Balance XT™ | — | — | — | — | — |
| Balance X™ | — | — | — | ● | — |
| Balance 55 | — | — | ● | — | — |
| Balance 35 | — | ● | — | — | — |
| Standard double | — | — | — | — | ● |
| Standard single | ● | — | — | — | — |
| CUTTING EQUIPMENT | | | | | |
| | ●/●/— | ●/●/— | ●/●/— | ●/●/— | ●/●/— |

● = Available (●) = Accessory — = Not available *Equivalent sound pressure level, according to ISO 22868, is calculated as the time-weighted energy total for different sound pressure levels under various working conditions. Typical statistical dispersion for equivalent sound pressure level is a standard deviation of 1 dB (A). **Noise emissions in the environment measured as sound power (LWA) in conformity with EC directive 2000/14/EC. The guaranteed sound power level includes variation in production as well as variation from the test code with 1–3 dB(A). ***Equivalent vibration level, according to ISO 22867, is calculated as the time-weighted energy total for vibration levels under various working conditions. Reported data for equivalent vibration level has a typical statistical dispersion (standard deviation) of 1 m/s².

! ALWAYS USE GENUINE HUSQVARNA LUBRICANTS AND SPARE PARTS FOR YOUR BRUSHCUTTER OR TRIMMER

These high quality spare parts and lubricants are developed to facilitate the care and maintenance of your Husqvarna equipment and enable trouble-free operation and storage. Husqvarna recommend regular service done by qualified technicians using only Husqvarna original or recommended spare parts. This will support the product's performance and lifetime. See your owner's manual or consult your Authorised Husqvarna dealer if any uncertainty occurs.



| | 545RX | 545RXT | 555RXT | 553RBX |
|--|---------|---------|---------|---------|
| | | | | |
| | 45.7 | 45.7 | 53.3 | 50.6 |
| | 2.1 | 2.1 | 2.8 | 2.3 |
| | 0.9 | 0.9 | 1.1 | 0.8 |
| | 101 | 100 | 101 | 97 |
| | 117 | 117 | 121 | 118 |
| | 3.2/2.9 | 3.2/2.9 | 1.5/1.6 | — |
| | — | — | — | 2.7/3.8 |
| | 8.9 | 8.7 | 9.2 | 12.1 |
| | | | | |
| | — | ● | — | — |
| | ● | ● | ● | — |
| | ● | ● | — | ● |
| | ● | ● | ● | ● |
| | ● | ● | ● | ● |
| | ● | ● | ● | ● |
| | ● | ● | ● | — |
| | ● | ● | ● | — |
| | ● | ● | ● | — |
| | ● | ● | ● | ● |
| | ● | ● | ● | ● |
| | ● | ● | ● | ● |
| | ● | ● | ● | — |
| | ● | ● | ● | ● |
| | ● | ● | ● | — |
| | — | ● | ● | — |
| | ● | — | — | — |
| | — | — | — | — |
| | — | — | — | — |
| | — | — | — | — |
| | — | — | — | — |
| | — | — | — | — |
| | ●/●/(●) | ●/●/(●) | ●/●/(●) | ●/●/— |

| COMBI MACHINES | 525LK | 535LK |
|--|---------|-----------|
| TECHNICAL SPECIFICATIONS | | |
| Cylinder displacement, cm ³ | 25.4 | 34.6 |
| Power output, kW | 1.0 | 1.6 |
| Fuel tank, litres | 0.51 | 0.6 |
| Sound pressure level at operators ear, dB(A)* | 94 | 99 |
| Sound power level guaranteed (LWA) dB(A)** | 106 | 114 |
| Equivalent vibration level (ahv, eq) front/rear handle, m/s ² *** | 3.0/3.3 | 4.5 / 3.9 |
| Weight (excl. cutting equipment), kg | 4.5 | 5.8 |
| FEATURES | | |
| Auto-return stop switch | ● | ● |
| "Click on" attachments | ● | ● |
| Combi-guard | — | — |
| Comfort handle | ● | ● |
| Detachable shaft | ● | ● |
| Ergonomic handle | ● | ● |
| Fuel pump | ● | ● |
| Grass bevel gear | ● | ● |
| Low Vib [®] | — | — |
| Smart Start [®] | ● | — |
| Soft grip handle | ● | ● |
| Standalone starter | ● | ● |
| Tap-n-Go trimmer head | ● | ● |
| Tool-less adjustment of handlebar / handle | ● | ● |
| X-Torq [®] engine | ● | ● |



NOMINAL POWER A new machinery directive (2006/42/EC) came into force on January 1, 2010, requiring manufacturers to declare the nominal power of engines, in kilowatts (kW). The power rating of the engines indicated is the average net power output during a normal working situations and meets applicable noise regulations (at specified rpm, see owner manual) of a typical production engine for the engine model measured to SAE standard J 1349/ISO 1585. Mass production engines may differ from this value. Actual power output for the engine installed in the final machine will depend on the operating speed, environmental conditions and other variables.

GET ONE MACHINE FOR EVERY TASK



ATTACHMENTS THAT HELP YOU GET RID OF EVERYTHING

Start by choosing the machine that best suits your needs – then explore our wide range of attachments. Each attachment offers a quick connection, durable design and – most importantly – sufficient power to trim dense grass, cut vigorous bushes, blow or sweep huge piles of leaves and debris. Just to give some examples of what we can help you get rid of.

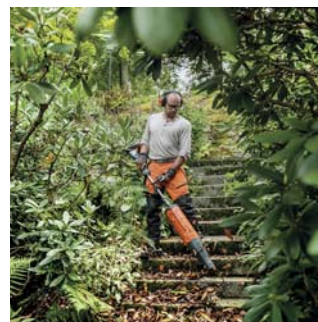

ENJOY HIGHLY EFFICIENT WORK – AT WHATEVER HEIGHT

We never compromise when it comes to power, durability and productivity. Therefore, we have designed our combi machines to work equally well as our conventional machines. This means that you can enjoy convenient and powerful pole sawing, as well as really efficient and reliable cultivating.



MAXIMUM VERSATILITY WHATEVER THE TASK

Our combi trimmers are the perfect choice if you want to have a truly smart, versatile work tool. You will only have to start and warm up one machine – then you are able to quickly and easily switch between many attachments to deal with all kinds of tasks – all year round. For maximum ease of use and low noise select the battery powered 325iLK which is designed for part-time use. The petrol and battery power units, together with all attachments, are as powerful and efficient as the conventional trimmers, pole saws, hedge trimmers, and so on. Also, a combi machine means less space for storage as well as less time and money for maintenance and service.

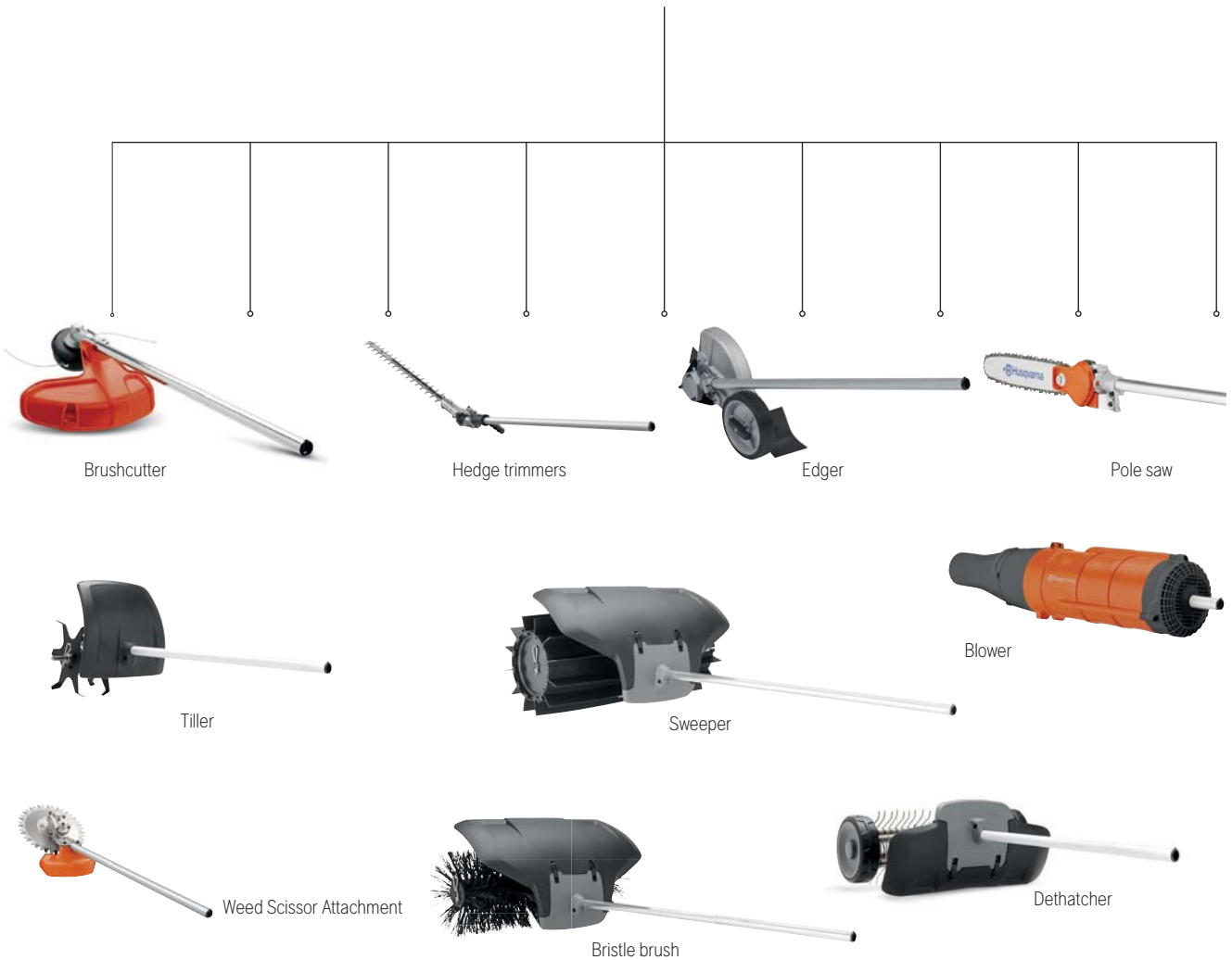

RELIABLE PERFORMANCE

The petrol and battery power units, together with all attachments, are as powerful and efficient as the conventional trimmers, pole saws, hedge trimmers, and so on. All to give you reliable workmates that help you get the job done at all times.

START UP ONE MACHINE

If you choose petrol power you will only have to start and warm up one machine – then you are able to quickly and easily switch between many attachments to deal with all kinds of tasks – all year round.

COMBI MACHINES



325iLK







High performance battery combi machine designed for part-time use. Includes TA850 trimmer attachment.

- Brushless motor
- Multi-use
- Power unit only
- 3 performance modes
- 13 attachments available
- 25cm² petrol performance

| Voltage | Motor type | Vibration levels F/R | Weight |
|------------------------------------|----------------|----------------------------|-----------------------|
| 36V Li-ion | BLDC Brushless | 2.6 / 1.0 m/s ² | 38 kg (excl. battery) |
| Model | Order PNC | RRP ex VAT | RRP inc VAT |
| 325iLK | 967 85 01-01 | £290.83 | £349.00 |
| Unit + BLi30 & QC250 (recommended) | | £556.66 | £667.99 |

| WORKING TIME ON ONE CHARGE | 325iLK | |
|----------------------------|--------|-------|
| | LIGHT | TOUGH |



| | | | |
|---|---------------|------------|--------|
|  | BLi20 | 45 min | 20 min |
|  | BLi30 | 1 h 15 min | 40 min |
|  | BLi200 | 50 min | 30 min |
|  | BLi300 | 1 h 40 min | 50 min |

A range of applications can be managed using one power unit making them extremely flexible tools. The battery powered 325iLK is designed for part-time use and ideal in noise sensitive areas and the 500 series is designed for full-time professional use. All attachments are designed for full time professional use and can be used on both petrol and battery powered machines.

Ideal for applications including:

- All round garden maintenance
- Landscaping
- Bushes and trees
- Hard surfaces and soil
- Grass
- Lawn maintenance

525LK



Professional combi machine designed for full time use. Takes a variety of attachments for a wide range of applications.

- X-Torq®
- Multi-use
- Power unit only
- Smart Start®
- Attachments available

| Displacement | Power output | Vibration levels F/R | Weight |
|----------------------|----------------|----------------------------|----------------|
| 25.4 cm ³ | 1.0kW / 1.3 hp | 3.0 / 3.3 m/s ² | 4.5 kg |
| Model | Order PNC | RRP ex VAT | RRP inc VAT |
| 525LK - Unit only | 967 14 83-01 | £315.83 | £379.00 |

535LK



High performance professional combi machine designed for full time use. Takes a variety of attachments for a wide range of applications.

- X-Torq®
- Comes with trimmer attachment
- T35 Tap'n'Go™ head
- Multi-use
- Attachments available

| Displacement | Power output | Vibration levels F/R | Weight |
|----------------------|----------------|----------------------------|----------------|
| 34.6 cm ³ | 1.6kW / 2.2 hp | 4.5 / 3.9 m/s ² | 5.8 kg |
| Model | Order PNC | RRP ex VAT | RRP inc VAT |
| 535LK | 967 68 81-01 | £482.50 | £579.00 |

REPLACEMENT CUTTING EQUIPMENT

| Model | 325iLK / 525LK | 535LK |
|-----------------------|----------------|---------------|
| Head | T35 M10 | T35 M10 |
| PNC | 578 44 63-01 | 578 44 63-01 |
| Ex VAT | £14.99 | £14.99 |
| Inc VAT | £17.99 | £17.99 |
| Recommended line size | | |
| Line Diameter | 2.4 - 2.7 mm | 2.4 - 2.7 mm |
| Guard type | Combi guard | Combi guard |
| PNC | 588 11 79-01 | 588 11 79-01 |
| Ex VAT | £21.66 | £21.66 |
| Inc VAT | £25.99 | £25.99 |

HUSQVARNA RECOMMEND

Opti Quadra and Opti Penta trimmer lines for a heavier duty line. Page 92

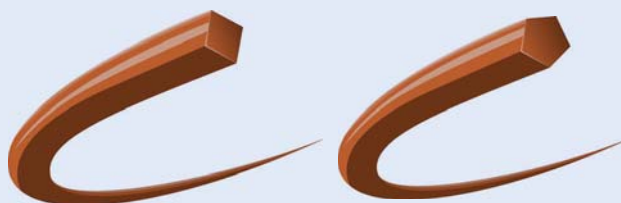

CLICK-IN-CLICK-OUT

The combi attachments are easy to change over with minimal effort using the click-in-click-out mechanism.



PRODUCT SPECIFICATIONS

Please see page 83 for full specifications.



COMBI ATTACHMENTS



A wide range of attachments designed to cover all aspects of outdoor maintenance from grass trimming through to hard surface cleaning, maximising machine flexibility. All attachments are designed for full time professional use and can be used on both petrol and battery power units.

Ideal for applications including:

- All round garden maintenance
- Landscaping
- Bushes and trees
- Hard surfaces and soil
- Grass
- Lawn maintenance

TRIMMER TA 850



Trimmer attachment equipped with combination guard and T35 Tap-n-Go™ trimmer head. Blade capable (J-handle kit required) Weight 1.2 kg

| Fits to | Order PNC | RRP ex VAT | RRP inc VAT |
|----------|--------------|------------|----------------|
| LK / iLK | 537 35 35-01 | £91.66 | £109.99 |

WEED SCISSORS RA850



Cutting attachment for weed control and grass edging along footpaths and gravel paths. Reduces the risk of scattered stones and debris. Weight 2.5 kg

| Fits to | Order PNC | RRP ex VAT | RRP inc VAT |
|----------|--------------|------------|----------------|
| LK / iLK | 967 90 85-01 | £290.83 | £349.00 |

EDGER ECA850



Edging attachment, ideal for keeping lawn, pathway and flowerbed edges neat. Features adjustable support wheel and curved shaft. Weight 3.2 kg

| Fits to | Order PNC | RRP ex VAT | RRP inc VAT |
|----------|--------------|------------|----------------|
| LK / iLK | 967 92 55-04 | £116.66 | £139.99 |

EDGER ESA850



Edging attachment, ideal for keeping lawn, pathway and flowerbed edges neat. Features adjustable support wheel. Weight 3.2 kg

| Fits to | Order PNC | RRP ex VAT | RRP inc VAT |
|----------|--------------|------------|----------------|
| LK / iLK | 967 92 56-04 | £124.99 | £149.99 |

HEDGE TRIMMER HA 200

NEW



Short reach adjustable hedge trimmer attachment. 60 cm / 23.6" blade length. Head adjustment 135°. Tube length 11 cm. Weight 2.3 kg

| Fits to | Order PNC | RRP ex VAT | RRP inc VAT |
|---------|--------------|------------|----------------|
| LK | 596 31 65-01 | £274.17 | £329.00 |

HEDGE TRIMMER HA 860

NEW



Long reach adjustable hedge trimmer attachment ideal for hedge tops. 60 cm / 23.6" blade length. Head adjustment 135°. Tube length 85 cm. Weight 2.6 kg

| Fits to | Order PNC | RRP ex VAT | RRP inc VAT |
|----------|--------------|------------|----------------|
| LK / iLK | 596 31 66-01 | £315.83 | £379.00 |

TILLER CA 230



Tiller attachment, ideal for use on flowerbeds and smaller areas of soil. Features heavy duty gearbox and 2 tines. Weight 3 kg

| Fits to | Order PNC | RRP ex VAT | RRP inc VAT |
|----------|--------------|------------|----------------|
| LK / iLK | 967 29 42-01 | £182.50 | £219.00 |

SWEEPER SR 600-2



Rubber broom attachment, ideal for sweeping sand and gravel from paths, driveways and lawns. Guard is included. Working width 60 cm. Weight 6.5 kg

| Fits to | Order PNC | RRP ex VAT | RRP inc VAT |
|----------|--------------|------------|----------------|
| LK / iLK | 967 29 44-01 | £332.50 | £399.00 |

BLOWER BA 101



Blower attachment, ideal for clearing paths and driveways from leaves, litter and grass clippings. Airflow 15 m³/min, Air speed 66 m/s. Weight 1.9 kg

| Fits to | Order PNC | RRP ex VAT | RRP inc VAT |
|----------|--------------|------------|----------------|
| LK / iLK | 967 28 64-01 | £124.99 | £149.99 |

EXTENSION EX 780



Shaft extension that gives an extra reach of 78 cm. Weight 0.6 kg

| Fits to | Order PNC | RRP ex VAT | RRP inc VAT |
|----------|--------------|------------|---------------|
| LK / iLK | 967 29 71-01 | £58.33 | £69.99 |

POLE SAW PA 1100



Pole saw attachment, ideal for pruning when additional reach is required. Cuts branches up to approx. 15 cm in thickness. Length 110 cm. Weight 1.4 kg

| Fits to | Order PNC | RRP ex VAT | RRP inc VAT |
|----------|--------------|------------|----------------|
| LK / iLK | 537 18 33-23 | £249.17 | £299.00 |

SCARIFIER DT600



Dethatcher attachment for removal of moss and thatch to provide a healthier lawn. Working width 60 cm. Weight 6.4 kg

| Fits to | Order PNC | RRP ex VAT | RRP inc VAT |
|----------|--------------|------------|----------------|
| LK / iLK | 967 29 69-01 | £332.50 | £399.00 |

BRUSH BR600



Bristle brush attachment, ideal for sweeping dirt from paths, driveways and in deep grooves. Guard is included. Working width 60 cm. Weight 5.5 kg

| Fits to | Order PNC | RRP ex VAT | RRP inc VAT |
|----------|--------------|------------|----------------|
| LK / iLK | 967 29 67-01 | £332.50 | £399.00 |

BRUSH CUTTER BCA 850



Brush cutter attachment with combination guard and Multi 255-4 grass blade. Inc. J-handle & harness. Weight 2.6 kg

| Fits to | Order PNC | RRP ex VAT | RRP inc VAT |
|----------|--------------|------------|----------------|
| LK / iLK | 967 18 59-01 | £99.99 | £119.99 |



CUTTING EQUIPMENT



All Husqvarna trimmer heads, trimmer lines and blades are designed to do more than simply cut. Their outstanding design, high quality materials and facilitating technology offer top level performance, efficiency and safety no matter what your application.

TRIMMER HEAD - TAP-N-GO™ 25-55C



Tap-n-Go™ function automatically feeds line when the head is pushed into the ground. X variants have a longer working life due to a Tap-n-Go™ button with ball bearing. T35 Universal includes adapters that allow it to be attached to most other trimmers.

| Item | Order PNC | RRP ex VAT | RRP inc VAT |
|--------------------------------------|--------------|------------|---------------|
| T25 3/8" Semi auto - Curved shaft | 578 44 60-01 | £12.49 | £14.99 |
| T25 M10 Semi auto - Straight shaft | 578 44 61-01 | £12.49 | £14.99 |
| T25B M8 Semi auto - Battery | 589 87 32-01 | £12.49 | £14.99 |
| T25B M10 Semi auto - Battery | 579 29 40-02 | £12.49 | £14.99 |
| T25C 3/8" Semi auto - Curved shaft | 578 44 59-01 | £12.49 | £14.99 |
| ErgoFeed™ | 594 72 70-01 | £17.49 | £20.99 |
| T35 M10 Semi auto | 578 44 63-01 | £14.99 | £20.00 |
| T35 M10 Semi auto - Universal | 578 44 94-01 | £16.66 | £19.99 |
| T35 M12 Semi auto | 578 44 64-01 | £14.99 | £17.99 |
| T35X M10 Semi auto (w. ball bearing) | 578 44 65-01 | £20.83 | £24.99 |
| T35X M12 Semi auto (w. ball bearing) | 578 44 66-01 | £20.83 | £24.99 |
| T45X M12 Semi auto (w. ball bearing) | 578 44 68-01 | £27.49 | £32.99 |
| T55X M12 Semi auto (w. ball bearing) | 578 44 70-01 | £33.33 | £39.99 |

TRIMMER HEAD - MANUAL 25-55C



The line is fed manually by the user by pushing the line feed button and pulling the cord. This enables the user to select the length of line to achieve the effect desired.

| Item | Order PNC | RRP ex VAT | RRP inc VAT |
|---------------------------|--------------|------------|---------------|
| S35 M10 | 578 44 74-01 | £14.99 | £17.99 |
| S35 M12 | 578 44 76-01 | £14.99 | £17.99 |
| S11 M12 (w. ball bearing) | 578 44 78-01 | £37.49 | £44.99 |

TRIMMER HEAD - TRI-CUT



Distinct design with plastic blades instead of trimmer line, ideal for coarser grass and terrain with stones. Highly visible, replaceable plastic flails which are safe to use around trees and bushes.

| Item | Order PNC | RRP ex VAT | RRP inc VAT |
|-------------|--------------|------------|---------------|
| Tri Cut M10 | 578 44 91-01 | £31.66 | £37.99 |
| Tri Cut M12 | 578 44 93-01 | £31.66 | £37.99 |

TRIMMER HEAD - ALLOY



Robust and reliable with quick and easy line loading. Maintenance is minimised and the low cutting height gives a tidy result.

| Item | Order PNC | RRP ex VAT | RRP inc VAT |
|----------------------|--------------|------------|---------------|
| Alloy Manual - Fixed | 578 44 82-01 | £20.83 | £24.99 |



PRODUCT USE GUIDE

Use the guide below to help you select the best trimmer head for your needs.

| | | RECOMMENDED ENGINE DISPLACEMENT | CORD FEED | DURABILITY | USE | LINE SIZE | LINE CAPACITY | THREAD |
|---|-----------------------|---------------------------------|----------------|------------|----------------------|--------------|---------------|----------------------|
|  | T55X | 55 cm ³ | Semi automatic | ●●●●● | Heavy grass Grass | 3 - 4 mm | 10 - 6m | M12 |
| | T45X | 45 cm ³ | Semi automatic | ●●●●● | Heavy grass Grass | 2.7 - 3.3 mm | 9 - 7.5m | M12L |
|  | T35X | 25 - 35 cm ³ | Semi automatic | ●●●●● | Grass | 2.4 - 2.7 mm | 8.5 - 7m | M10L M12L |
| | T35 | 25 - 35 cm ³ | Semi automatic | ●●●●○ | Grass | 2.4 - 2.7 mm | 8.5 - 7m | M10L 12L Univ. |
|  | T25 | 25 cm ³ | Semi automatic | ●●●●○ | Grass | 2 - 2.4 mm | 6 - 5m | 3/8"R M10L |
| | T25B | Battery | Semi automatic | ●●●●○ | Grass | 2 - 2.4 mm | 6 - 5m | M10 M8 |
| | T25C | 25 cm ³ | Semi automatic | ●●●●○ | Grass | 2 mm | 5 - 4m | 3/8"R M10 M8 |
|  | E35B Ergofeed™ | Battery 535iRXT | Semi automatic | ●●●●○ | Grass | 2.4 - 2.7 mm | | |
|  | S35 | 30 cm ³ | Manual | ●●●●○ | Grass | 2.4 - 2.7 mm | 8 - 7m | M10L |
| | | 30 - 42 cm ³ | | | | | | M12L |
|  | Trimmy SII | 50 cm ³ | Manual | ●●●●○ | Heavy grass Grass | 2 - 3.3 mm | 9 - 5m | M12 |
|  | Alloy | All displacements | Manual | ●●●●● | Heavy grass Grass | 2 - 3.3 mm | - | N/A |
|  | TriCut | All displacements | - | ●●●●● | Heavy grass Grass | - | - | M10L M12L |



TRIMMER LINE - OPTI ROUND

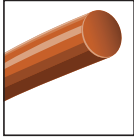

| Diameter (mm) | Length (m) | Order PNC | RRP ex VAT | RRP inc VAT |
|---------------|------------|--------------|------------|----------------|
| ● Ø1.5 | 15 | 597 66 88-01 | £316 | £3.79 |
| ● Ø2.0 | 15 | 597 66 88-10 | £3.49 | £4.19 |
| ● Ø2.0 | 130 | 597 66 88-11 | £12.41 | £14.89 |
| ● Ø2.4 | 15 | 597 66 88-20 | £3.91 | £4.69 |
| ● Ø2.4 | 90 | 597 66 88-21 | £12.41 | £14.89 |
| ● Ø2.4 | 240 | 597 66 88-22 | £2716 | £32.59 |
| ● Ø2.7 | 12 | 597 66 88-30 | £3.91 | £4.69 |
| ● Ø2.7 | 70 | 597 66 88-31 | £12.41 | £14.89 |
| ● Ø2.7 | 240 | 597 66 88-32 | £33.33 | £39.99 |
| ● Ø3.0 | 10 | 597 66 88-40 | £3.91 | £4.69 |
| ● Ø3.0 | 56 | 597 66 88-41 | £12.41 | £14.89 |
| ● Ø3.0 | 240 | 597 66 88-42 | £4108 | £49.29 |
| ● Ø3.0 | 637 | 597 66 88-43 | £94.58 | £113.49 |
| ○ Ø3.3 | 75 | 597 66 88-50 | £18.66 | £22.39 |
| ○ Ø3.3 | 240 | 597 66 88-51 | £4108 | £49.29 |
| ○ Ø3.3 | 530 | 597 66 88-52 | £94.58 | £113.49 |

TRIMMER LINE - OPTI QUADRA

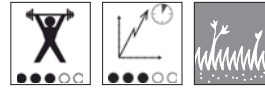
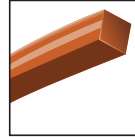

| Diameter (mm) | Length (m) | Order PNC | RRP ex VAT | RRP inc VAT |
|---------------|------------|--------------|------------|----------------|
| ● Ø2.4 | 70 | 597 66 89-01 | £12.41 | £14.89 |
| ● Ø2.4 | 210 | 597 66 89-02 | £28.66 | £34.39 |
| ● Ø2.7 | 55 | 597 66 89-10 | £12.41 | £14.89 |
| ● Ø2.7 | 170 | 597 66 89-11 | £28.66 | £34.39 |
| ● Ø3.0 | 48 | 597 66 89-20 | £12.41 | £14.89 |
| ● Ø3.0 | 240 | 597 66 89-21 | £48.83 | £58.59 |
| ● Ø3.0 | 528 | 597 66 89-22 | £90.66 | £108.79 |
| ○ Ø3.3 | 65 | 597 66 89-30 | £18.58 | £22.29 |
| ○ Ø3.3 | 183 | 597 66 89-31 | £45.74 | £54.89 |
| ○ Ø3.3 | 437 | 597 66 89-32 | £94.58 | £113.49 |
| ● Ø4.0 | 65 | 597 66 89-40 | £24.83 | £29.79 |
| ● Ø4.0 | 240 | 597 66 89-41 | £82.91 | £99.49 |

TRIMMER LINE - OPTI PENTA

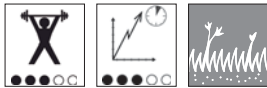
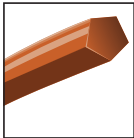

| Diameter (mm) | Length (m) | Order PNC | RRP ex VAT | RRP inc VAT |
|---------------|------------|--------------|------------|---------------|
| ● Ø2.4 | 90 | 597 66 90-01 | £12.41 | £14.89 |
| ● Ø2.4 | 240 | 597 66 90-02 | £2716 | £32.59 |
| ● Ø2.7 | 70 | 597 66 90-10 | £12.41 | £14.89 |
| ● Ø2.7 | 240 | 597 66 90-11 | £33.33 | £39.99 |
| ● Ø3.0 | 56 | 597 66 90-20 | £12.41 | £14.89 |
| ● Ø3.0 | 240 | 597 66 90-21 | £4108 | £49.29 |
| ○ Ø3.3 | 75 | 597 66 90-30 | £18.58 | £22.29 |

TRIMMER LINE - WHISPER TWIST

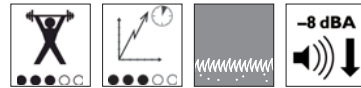

| Diameter (mm) | Length (m) | Order PNC | RRP ex VAT | RRP inc VAT |
|---------------|------------|--------------|------------|---------------|
| ● Ø1.5 | 15 | 597 66 91-01 | £4.24 | £5.09 |
| ● Ø2.0 | 15 | 597 66 91-10 | £4.24 | £5.09 |
| ● Ø2.0 | 112 | 597 66 91-11 | £15.49 | £18.59 |
| ● Ø2.4 | 12 | 597 66 91-20 | £4.66 | £5.59 |
| ● Ø2.4 | 77 | 597 66 91-21 | £15.49 | £18.59 |
| ● Ø2.4 | 210 | 597 66 91-22 | £3716 | £44.59 |
| ● Ø2.7 | 10 | 597 66 91-30 | £4.66 | £5.59 |
| ● Ø2.7 | 60 | 597 66 91-31 | £15.49 | £18.59 |
| ● Ø2.7 | 210 | 597 66 91-32 | £44.99 | £53.99 |
| ● Ø3.0 | 9 | 597 66 91-40 | £4.66 | £5.59 |
| ● Ø3.0 | 48 | 597 66 91-41 | £15.49 | £18.59 |
| ● Ø3.0 | 210 | 597 66 91-42 | £55.83 | £66.99 |

TRIMMER LINE - CORECUT

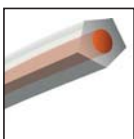

| Diameter (mm) | Length (m) | Order PNC | RRP ex VAT | RRP inc VAT |
|---------------|------------|--------------|------------|---------------|
| ○ Ø2.0 | 15 | 597 66 92-01 | £4.66 | £5.59 |
| ○ Ø2.0 | 112 | 597 66 92-02 | £17.83 | £21.39 |
| ○ Ø2.4 | 12 | 597 66 92-10 | £4.99 | £5.99 |
| ○ Ø2.4 | 90 | 597 66 92-11 | £17.83 | £21.39 |
| ○ Ø2.4 | 210 | 597 66 92-12 | £4108 | £49.29 |
| ○ Ø2.7 | 10 | 597 66 92-20 | £4.99 | £5.99 |
| ○ Ø2.7 | 60 | 597 66 92-21 | £17.83 | £21.39 |
| ○ Ø2.7 | 210 | 597 66 92-22 | £52.74 | £63.29 |
| ○ Ø3.0 | 9 | 597 66 92-30 | £5.08 | £6.09 |
| ○ Ø3.0 | 56 | 597 66 92-31 | £17.83 | £21.39 |
| ○ Ø3.0 | 210 | 597 66 92-32 | £64.33 | £77.19 |
| ○ Ø3.3 | 65 | 597 66 92-40 | £2716 | £32.59 |
| ○ Ø3.3 | 210 | 597 66 92-41 | £77.49 | £92.99 |
| ○ Ø4.0 | 65 | 597 66 92-50 | £35.66 | £42.79 |
| ○ Ø4.0 | 138 | 597 66 92-51 | £75.16 | £90.19 |

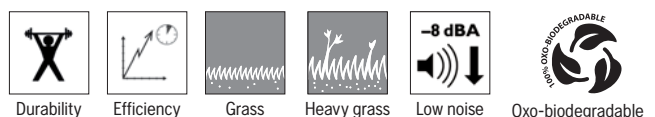



GRASS BLADES



For dense, coarse grass, but not for woody growth.

| Item | Order PNC | RRP ex VAT | RRP inc VAT |
|----------------|--------------|------------|---------------|
| Grass 250 - 8T | 578 44 40-01 | £1416 | £16.99 |
| Grass 255 - 3T | 578 44 49-01 | £1416 | £16.99 |
| Grass 255 - 4T | 578 44 37-01 | £1416 | £16.99 |
| Grass 275 - 4T | 578 44 47-01 | £15.83 | £18.99 |
| Multi 300 - 3T | 578 44 45-01 | £16.66 | £19.99 |
| Multi 330 - 2T | 578 44 51-01 | £9.99 | £11.99 |
| Multi 350 - 3T | 578 44 44-01 | £25.83 | £30.99 |

SAW BLADES



Efficient and durable with a tooth design that gives a smooth cut and reduces the risk of the blade getting pinched in the wood.

| Item | Order PNC | RRP ex VAT | RRP inc VAT |
|--------------------|--------------|------------|---------------|
| Scarlett 200 - 22T | 597 46 82-01 | £13.33 | £15.99 |
| Scarlett 225 - 24T | 597 46 89-01 | £14.16 | £16.99 |

EDGER BLADE

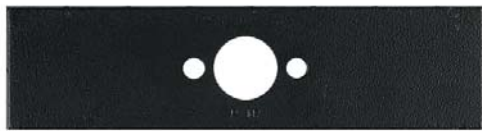

Durable 19 cm edger blade allows for a cutting depth up to 6 cm for edging your lawn.

| Item | Order PNC | RRP ex VAT | RRP inc VAT |
|-------------|--------------|------------|---------------|
| Edger Blade | 503 84 82-02 | £916 | £10.99 |

PLASTIC BLADES



Replaceable plastic blades for Tri Cut head.

| Item | Order PNC | RRP ex VAT | RRP inc VAT |
|-------------------|--------------|------------|--------------|
| 6 pieces - 255 mm | 531 01 77-14 | £1.24 | £1.49 |
| 6 pieces - 300 mm | 531 01 77-15 | £1.24 | £1.49 |

SHREDDER BLADE

NEW



Shredder blade for mulching applications such as coarse grass, bushes and bramble with stems up to 2cm. Must be used with appropriate shredder guard.

| Item | Order PNC | RRP ex VAT | RRP inc VAT |
|---------------------------------|-----------|------------|----------------|
| Shredder Blade 1" | 589775301 | £27.49 | £32.99 |
| Shredder Blade 20 mm | 589775501 | £27.49 | £32.99 |
| Shredder Blade 1", Bulk 10pcs | 589775310 | £190.83 | £229.00 |
| Shredder Blade Kit 1" Inc guard | 544842901 | £74.99 | £89.99 |

HUSQVARNA RECOMMEND
 Technical Brushcutter and Trimmer clothing.
 Page 172





CUTTING EQUIPMENT GUIDE

| MODEL | GRASS | COARSE GRASS |
|----------------|--------------------------|-----------------------|
| 555RXT | A5 + 12 13 14 | C3 + E2 E3 + 4 5 6 |
| 553RBX | A4 B2 + 9 10 11 12 14 16 | B2 + E4 + 3 4 6 7 |
| 543RS | A4 B2 + 9 10 11 12 14 16 | B2 + E4 + 3 4 6 7 |
| 545RXT/545RX | A2 B4 + 12 13 14 16 | C1 B4 + E2 E3 + 3 4 6 |
| 535iRXT | A11 + 10 11 19 | C4 + E4 + 2 3 4 6 |
| 535iRX/ 53i5FR | A11 + 10 11 | C4 + E4 + 2 3 4 6 |
| 535RXT/135R | A4 B2 + 9 10 11 12 14 16 | B2 + E4 + 2 3 4 6 |
| 535LK | B1 + 3 6 7 8 15 | |
| 525RXT/525RX | A1 B1 + 3 5 6 7 8 15 | B1 + E1 + 1 2 3 |
| 525RJX | A1 B1 + 1 3 6 7 8 15 | B1 + E1 + 2 |
| 525LK | A1 B1 + 1 3 6 7 8 15 | |
| 520iRX | A7 + 17 | 2 3 |
| 520iLX | A7 + 17 | F4 + 2 3 |
| 325iLK | A12 + 1 3 6 7 | F1 |

| TRIMMER GUARDS | COMBINATION GUARDS | GRASS BLADE GUARDS | SAW BLADE GUARDS | SUPPORT CUPS | KITS |
|------------------|--------------------|--------------------|---|---|---|
| A1 588 54 37-01 | B1 588 11 79-01 | C1 537 28 85-01 | D1 537 29 95-01 200 mm (adapter incl.) | E1 503 89 01-01 | F1 537 04 85-01 incl. B1 E1 2 |
| A2 503 95 43-01 | B2 537 33 16-01 | C2 537 29 74-01 | D2 537 31 09-02 200 mm (adapter incl.) | E2 503 90 18-02 (20 mm/1") | |
| A3 537 29 73-01 | B3 545 03 09-01 | C3 502 46 49-01 | D3 502 30 36-01 200 mm | E3 502 15 70-02 M12 (20 mm/1") Ballbearing | F2 952 71 56-16 incl. E1 2 |
| A4 537 34 94-03 | B4 544 46 43-01 | C4 590 88 00-01 | D4 574 50 67-02 225 mm | E4 503 89 01-02 M12 | |
| A5 544 10 74-02 | B5 580 44 66-06 | | D5 501 32 04-02 200 mm (adapter incl.) | | F3 544 24 96-01 incl. B2 E4 2 |
| A6 502 46 50-01 | | | D6 502 43 55-01 225 mm (adapter incl.) | | |
| A7 577 01 83-03 | | | | | F4 587 37 50-01 For blade attachment |
| A8 580 44 66-10 | | | | | |
| A9 577 96 51-01 | | | | | |
| A10 585 33 92-01 | | | | | |
| A11 590 88 01-01 | | | | | |
| A12 590 88 01-01 | | | | | |



| | BUSHES AND TREES | HARD SURFACES | ATTACHMENTS | MIN-MAX TRIMMER LINE DIAMETER (SUPPLIED HEAD) | SUPPLIED HARNESS |
|--|------------------|---------------|---------------------|---|-----------------------------|
| | D6 + 9 | | | 3.0 - 4.0 mm | BALANCE XT |
| | | | | 2.7 - 3.3 mm | INTEGRATED |
| | | | | 2.7 - 3.3 mm | STANDARD DOUBLE |
| | D2 + 8 | | | 2.7 - 3.3 mm | BALANCE XT / X |
| | | | | 2.4 - 2.7 mm | BALANCE XB |
| | | | | 2.4 - 2.7 mm | BALANCE XB |
| | D5 + 8 | | | 2.4 - 2.7 mm | BALANCE X / STANDARD DOUBLE |
| | 1 5 6 7 | 13 15 | 2 3 4 8 16 17 18 21 | 2.4 - 2.7 mm | - |
| | D1 + 8 | | | 2.4 - 2.7 mm | BALANCE 55 / 35 |
| | | | | 2.4 - 2.7 mm | - |
| | 1 5 6 7 | 13 15 | 2 3 4 8 16 17 18 21 | - | - |
| | | | | 2.0 - 2.4 mm | BALANCE 35B |
| | | | | 2.0 - 2.4 mm | - |
| | 1 6 | 13 15 | 2 3 8 16 17 18 21 | 2.0 - 2.4 mm | - |

| CUTTING EQUIPMENTS | | | | ATTACHMENTS | | | | | | | | | |
|--------------------|--|------------|--|-------------|---------------------------------------|-------------|--|---|---|--|--|--|--|
| 1 | 578 44 82-01 Alloy | (Fixed) | | 11 | 578 44 66-01 T35X M12 | (Semiauto) | | 1 | 578 44 40-01 Grass 255-8 (1") | | 13 | 967 28 64-01 BA 101 | |
| 2 | 578 44 60-01 T25 (R) | (Semiauto) | | 12 | 578 44 68-01 T45X M12 | (Semiauto) | | 2 | 578 44 37-01 Grass 255-4 (1") | | 15 | 967 29 67-01 BR 600 | |
| 3 | 578 44 61-01 T25 | (Semiauto) | | 13 | 578 44 70-01 T55X M12 | (Semiauto) | | 3 | 578 44 49-01 Multi 255-3 (1") | | 16 | 967 29 69-01 DT 600 | |
| 4 | 578 44 59-01 T25C (R) | (Semiauto) | | 14 | 578 44 78-01 S11 M12 | (Manual) | | 4 | 578 44 47-01 Multi 275-4 (1") | | 17 | 967 29 42-01 CA 230 | |
| 5 | 578 44 74-01 S35 M10 | (Manual) | | 15 | 578 44 91-01 TriCut M10 | | | 5 | 578 44 44-01 Multi 350-3 (1") | | 18 | 579 44 35-01 Second blade set, fits CA 230 | |
| 6 | 578 44 63-01 T35 M10 | (Semiauto) | | 16 | 578 44 93-01 TriCut M12 | | | 6 | 578 44 45-01 Multi 300-3 (1") | | 21 | 967 90 85-01 RA 850 | |
| 7 | 578 44 65-01 T35X M10 | (Semiauto) | | 17 | 579 29 40-03 T25B M10 | (Semiauto) | | 7 | 578 44 51-01 Multi 330-2 (1") | | 7 | 967 29 71-01 EX 780 | |
| 8 | 578 44 71-01 Superauto II M10 (1") | | | 18 | 589 87 32-01 T25B M8 | (Semiauto) | | 8 | 578 44 25-01 Scarlett 200-22 (1") | | 8 | 537 35 35-01 TA 850 | |
| 9 | 578 44 76-01 S35 M12 | (Manual) | | 19 | 594 72 70-01 E35B | (ErgoFeed™) | | 9 | 578 44 27-01 Scarlett 225-24 (1") | | A8 | 2 | |
| 10 | 578 44 64-01 T35 M12 | (Semiauto) | | | | | | | | | Cutting equipment highlighted in bold supplied with machine as standard equipment. | | |



SHARP TOOLS FOR GREAT LOOKS

A hedge needs time and care to stay healthy and beautiful. A well-kept hedge will provide you with privacy while giving the garden solid lines and visual appeal. Different hedges need different types of tools, which is important to keep in mind when buying a hedge trimmer. All Husqvarna hedge trimmers are powerful, precise and efficient to give great results every time. They're machines designed to make your work easier.



WHAT YOU GET AND HOW WE DO IT



BUILT TO LAST

No matter if you choose to use a battery or petrol-powered hedge trimmer, the overall robust design will provide a long service life and make sure your trimmer makes easy work of even the toughest of tasks.



LOWER YOUR IMPACT

Our battery-powered hedge trimmers are virtually free from emissions, whereas for petrol-powered machines, the engine technology helps reduce harmful exhaust emissions and increases fuel efficiency.



QUIET OPERATION

The battery operation or our low noise engine technology together with the special design make our hedge trimmers quiet and easy to use. A very important aspect for everyone who operates in residential areas.



SMOOTHER STARTING

The engine and starter have been designed so the machine starts quickly with minimum effort, getting you started quickly.



LOW VIBRATIONS

Our petrol-powered engines are equipped with effective anti-vibration dampeners that absorb vibrations, whereas battery-powered machines all produce much less vibration, sparing your arms and hands.



MAKE SURE YOU ALWAYS TRIM WITH FIRST CLASS RESULTS



Adjustable cutter bar angle



EXTENDED HEDGE TRIMMERS REACH WHERE OTHERS STRUGGLE

Articulating extended battery and petrol trimmers are perfect when you need to reach difficult places without losing performance. They have superb handling, are easy to start, suit both high and low hedges and with back folding cutting head making them extra easy to store and transport.

- + Difficult trimming
- + Low and high hedges
- + Great handling
- + Easy storage
- + Telescopic extension



DOUBLE-SIDED HEDGE TRIMMERS FLEXIBLE HANDLING AT ANY ANGLE

Double-sided hedge trimmers are designed for shaped sections of hedges. They offer efficient and comfortable operation with features such as Smart Start®, Low Vib® and adjustable handle on most models.

- + Shaping hedges
- + Coarse cutting
- + Great performance
- + Adjustable handles



SINGLE-SIDED HEDGE TRIMMERS STRAIGHT CUTS IN ONE MOVEMENT

Single-sided trimmers are supplied with long blades and still feature an optimised weight distribution to make it easier to make straight cuts with precision. The leaf catcher helps collecting leaves and debris, saving time and effort.

- + Wide hedges
- + Precision cutting
- + Comfortable operation
- + Coarse Cutting



Find out more on page 163









WHY CHOOSE A BATTERY HEDGE TRIMMER?

Low noise. No direct emissions. Low vibrations. Perfect balance. High performance. Extremely low operational cost. These are some of the criteria of an excellent hedge trimmer and that's exactly what you get from the Husqvarna Battery Series hedge trimmers. Lightweight and perfectly balanced to facilitate comfortable work, even when trimming for extended hours. Plus, you'll enjoy the low maintenance of a battery-powered tool.



PRODUCT USE GUIDE

Use this guide to help you select the best product for your needs.

| TYPE OF USE | MODEL | POWER SOURCE | DISPLACEMENT (CM ³) / VOLTAGE | WEIGHT | BLADE LENGTH | HEDGE TYPES | | | | PAGE |
|---|-----------|---|---|---------|--------------|--|---|---|---|------|
| | | | | | |  |  |  |  | |
| | | | | | | FINE | COARSE | FINE TALL | COARSE TALL | |
|  FULL-TIME USE (PROFESSIONAL) | 520iHD60 |  | 36V Li-ion | 3.8 kg* | 60 cm / 24" | ● | ● | ○ | ○ | 100 |
| | 520iHD70 |  | 36V Li-ion | 3.9 kg* | 70 cm / 28" | ● | ● | ○ | ○ | 100 |
| | 522HD60X | Petrol | 217 cm ³ | 4.9 kg | 60 cm / 24" | ● | ○ | ○ | ○ | 101 |
| | 522HDR60X | Petrol | 217 cm ³ | 5.0 kg | 60 cm / 24" | ○ | ● | ○ | ○ | 101 |
| | 522HDR75X | Petrol | 217 cm ³ | 5.2 kg | 75 cm / 30" | ○ | ● | ○ | ○ | 101 |
| | 522HS75X | Petrol | 217 cm ³ | 5.0 kg | 75 cm / 30" | ● | ○ | ○ | ○ | 101 |
| | 522HDR75X | Petrol | 217 cm ³ | 5.0 kg | 75 cm / 30" | ○ | ● | ○ | ○ | 101 |
| | 520iHE3 |  | 36V Li-ion | 4.1 kg* | 55 cm / 22" | ● | ● | ● | ● | 103 |
| | 520iHT4 |  | 36V Li-ion | 5.3 kg* | 55 cm / 22" | ● | ● | ● | ● | 103 |
| | 525HE3 | Petrol | 25.4 cm ³ | 6.35 kg | 55 cm / 22" | ● | ● | ● | ● | 102 |
| | 525HE4 | Petrol | 25.4 cm ³ | 6.4 kg | 55 cm / 22" | ● | ● | ● | ● | 102 |

The product selector is only to be used as a guide. Please visit your local Authorised Husqvarna dealer for more information.

* Excludes battery ● Optimised solution (guideline) ○ Capable solution but not optimal (guideline only)

HEDGE TRIMMERS



High performance petrol and battery hedge trimmers designed for professional use. The products feature heavy duty commercial gearboxes and high knife speed for efficient cutting. Consider a battery model for equivalent petrol performance with lower noise, running costs and no direct emissions.

Ideal for applications including:

- Landscape maintenance
- Parks and public spaces
- Noise sensitive areas (battery)
- Shaping

520iHD60

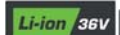

Very quiet but highly efficient professional battery hedge trimmer with excellent ergonomics. Weatherproof (IPX4) with low noise and vibrations.

- High torque motor
- Adjustable rear handle
- 4000 cuts/min blade speed
- Keypad with savE™
- Dual sided blade
- Weatherproof (IPX4)

| Voltage | Motor type | Vibration levels F/R | Weight |
|-------------------------------------|-------------------|----------------------------|------------------------|
| 36V Li-ion | High torque motor | 1.6 / 2.5 m/s ² | 3.8 kg (excl. battery) |
| Model | Order PNC | RRP ex VAT | RRP inc VAT |
| Unit Only - 60 cm | 967 91 56-02 | £374.17 | £449.00 |
| Unit + BLi200 & QC330 (recommended) | | £639.99 | £767.99 |

520iHD70



Very quiet but highly efficient professional battery hedge trimmer with excellent ergonomics. Weatherproof (IPX4) with low noise and vibrations.

- High torque motor
- Adjustable rear handle
- 4000 cuts/min blade speed
- Keypad with savE™
- Dual sided blade
- Weatherproof (IPX4)





| Voltage | Motor type | Vibration levels F/R | Weight |
|-------------------------------------|-------------------|----------------------------|------------------------|
| 36V Li-ion | High torque motor | 2.3 / 3.5 m/s ² | 3.9 kg (excl. battery) |
| Model | Order PNC | RRP ex VAT | RRP inc VAT |
| Unit Only - 70 cm | 967 91 57-02 | £415.83 | £499.00 |
| Unit + BLi200 & QC330 (recommended) | | £681.66 | £817.99 |

WORKING TIME ON ONE CHARGE

520iHD60 / 520iHD70

LIGHT TOUGH



| | | | |
|---|----------------|-------------|------------|
|  | BLi100 | 1 h | 30 min |
|  | BLi200 | 2 h | 1 h |
|  | BLi300 | 3 h 45 min | 1 h 45 min |
|  | BLi550X | 6 h 15 min | 3 h |
|  | BLi950X | 12 h 30 min | 6 h |

522HD60X



Fine cut professional hedge trimmer with high blade speed for fine trimming work. Low weight and low vibration with multi-position handle and open blade guard.

- Low Vib®
- Adjustable rear handle
- 4400 cuts/min blade speed
- Commercial gearbox
- Fine cut dual sided blade

| Displacement | Power output | Vibration levels F/R | Weight |
|----------------------|---------------|----------------------------|----------------|
| 21.7 cm ³ | 0.6kW / 0.8hp | 2.8 / 2.1 m/s ² | 4.9 kg |
| Blade length | Order PNC | RRP ex VAT | RRP inc VAT |
| 60 cm / 24" | 967 65 87-01 | £499.17 | £599.00 |

522HS75X



Fine cut professional single sided hedge trimmer with high blade speed for fine trimming work. Low weight and low vibration design with leaf catcher

- Low Vib®
- Leaf catcher
- 4400 cuts/min blade speed
- Commercial gearbox
- Fine cut single sided blade

| Displacement | Power output | Vibration levels F/R | Weight |
|----------------------|---------------|----------------------------|----------------|
| 21.7 cm ³ | 0.6kW / 0.8hp | 2.9 / 1.8 m/s ² | 5.0 kg |
| Blade length | Order PNC | RRP ex VAT | RRP inc VAT |
| 75 cm / 30" | 967 65 92-01 | £540.83 | £649.00 |

522HDR60X



Coarse cut professional hedge trimmer with lower blade speed for higher cutting power. Low weight and low vibration with multi-position handle and open blade guard.

- Low Vib®
- Adjustable rear handle
- 3200 cuts/min blade speed
- Commercial gearbox
- Rough cut dual sided blade

| Displacement | Power output | Vibration levels F/R | Weight |
|----------------------|---------------|----------------------------|----------------|
| 21.7 cm ³ | 0.6kW / 0.8hp | 3.8 / 1.3 m/s ² | 5.0 kg |
| Blade length | Order PNC | RRP ex VAT | RRP inc VAT |
| 60 cm / 24" | 967 65 83-01 | £499.17 | £599.00 |

522HSR75X



Coarse cut professional single sided hedge trimmer with lower blade speed for higher cutting power. Low weight and low vibration design with leaf catcher

- Low Vib®
- Leaf catcher
- 3200 cuts/min blade speed
- Commercial gearbox
- Rough cut single sided blade

| Displacement | Power output | Vibration levels F/R | Weight |
|----------------------|---------------|----------------------------|----------------|
| 21.7 cm ³ | 0.6kW / 0.8hp | 2.9 / 1.8 m/s ² | 5.0 kg |
| Blade length | Order PNC | RRP ex VAT | RRP inc VAT |
| 75 cm / 30" | 967 65 90-01 | £540.83 | £649.00 |

522HDR75X



Coarse cut professional hedge trimmer with lower blade speed for higher cutting power. Low weight and low vibration with multi-position handle and open blade guard.

- Low Vib®
- Adjustable rear handle
- 3200 cuts/min blade speed
- Commercial gearbox
- Rough cut dual sided blade

| Displacement | Power output | Vibration levels F/R | Weight |
|----------------------|---------------|----------------------------|----------------|
| 21.7 cm ³ | 0.6kW / 0.8hp | 3.1 / 2.2 m/s ² | 5.2 kg |
| Blade length | Order PNC | RRP ex VAT | RRP inc VAT |
| 75 cm / 30" | 967 65 84-01 | £524.17 | £629.00 |

HUSQVARNA RECOMMEND

XP® Power 2 Fuel



There is no better fuel for your Husqvarna product than our alkylate fuel manufactured to unique Husqvarna specifications. XP® Power 2 is mixed with exactly 2% of our XP® 2-stroke oil giving you a cleaner, cooler and healthier engine. Read more on pages 180 - 181.

POLE HEDGE TRIMMERS



Long reach petrol pole hedge trimmers designed for frequent use, products feature adjustable cutter bar for ergonomic trimming of ground cover and taller hedges. For professional applications select the long reach battery pole hedge trimmer, offering higher levels of torque versus petrol equivalents with much lower noise levels and no direct emissions.

Ideal for applications including:

- **Landscape maintenance**
- **Parks and public spaces**
- **Noise sensitive areas (battery)**
- **Ground cover**
- **Tall hedges**

525HE3



25cc pole hedge trimmer with high blade speed, designed for professional users. With a reach up to 3 meters reach and durable 135° angle adjustment, this versatile machine is suitable for both tall and low hedges.

- X-Torq®
- Rear bumper
- 4300 cuts/min blade speed
- Smart Start®
- Adjustable head
- Head adjustment 135°

| Displacement | Power output | Vibration levels F/R | Weight |
|----------------------|---------------|----------------------------|----------------|
| 25.4 cm ³ | 1.0kW / 1.3hp | 5.6 / 4.4 m/s ² | 5.9 kg |
| Blade length | Order PNC | RRP ex VAT | RRP inc VAT |
| 60 cm / 24" | 967 94 49-01 | £582.50 | £699.00 |

525HE4



25cc high reach pole hedge trimmer with 60cm cutter bar and high knife speed, designed for professional use. Up to 4 meters reach and durable 135° angle adjustment. Suitable for high, wide and low hedges.

- X-Torq®
- Rear bumper
- 4300 cuts/min blade speed
- Smart Start®
- Transport position
- Head adjustment 135°

| Displacement | Power output | Vibration levels F/R | Weight |
|----------------------|---------------|----------------------------|----------------|
| 25.4 cm ³ | 1.0kW / 1.3hp | 4.6 / 3.9 m/s ² | 6.3 kg |
| Blade length | Order PNC | RRP ex VAT | RRP inc VAT |
| 60 cm / 24" | 967 94 51-01 | £624.17 | £749.00 |

520iHE3



Highly efficient professional battery pole hedge trimmer with 3.5m reach, features adjustable cutter bar. Weatherproof (IPX4) with low noise and vibrations.

- Brushless motor
- Remote cutter adjustment
- 4000 cuts/min blade speed
- Keypad with savE™
- Transport position
- Head adjustment 120°

| Voltage | Motor type | Vibration levels F/R | Weight |
|-------------------------------------|----------------|----------------------------|-----------------------|
| 36V Li-ion | BLDC Brushless | 3.5 / 2.5 m/s ² | 41 kg (excl. battery) |
| Model | Order PNC | RRP ex VAT | RRP inc VAT |
| Unit only - 55 cm | 967 91 58-11 | £332.50 | £399.00 |
| Unit + BLi200 & QC330 (recommended) | | £598.33 | £717.99 |

520iHT4

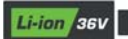





Telescopic professional battery pole hedge trimmer with 4.5m reach, features adjustable cutter bar. Weatherproof (IPX4) with low noise and vibrations.

- Brushless motor
- Extended length 3.5 m
- 4000 cuts/min blade speed
- Keypad with savE™
- Transport position
- Head adjustment 120°

| Voltage | Motor type | Vibration levels F/R | Weight |
|-------------------------------------|----------------|----------------------------|------------------------|
| 36V Li-ion | BLDC Brushless | 2.0 / 1.7 m/s ² | 5.3 kg (excl. battery) |
| Model | Order PNC | RRP ex VAT | RRP inc VAT |
| Unit only - 55 cm | 967 97 12-01 | £415.83 | £499.00 |
| Unit + BLi200 & QC330 (recommended) | | £681.66 | £817.99 |

| WORKING TIME ON ONE CHARGE | 520iHE3 / 520iHT4 | |
|----------------------------|-------------------|-------|
| | LIGHT | TOUGH |



| | | | |
|---|----------------|-------------|------------|
|  | BLi100 | 1 h | 30 min |
|  | BLi200 | 2 h | 1 h |
|  | BLi300 | 3 h 45 min | 1 h 45 min |
|  | BLi550X | 6 h 15 min | 3 h |
|  | BLi950X | 12 h 30 min | 6 h |

 **Locate your nearest dealer**
Visit: www.husqvarna.com/uk/dealer-locator

HUSQVARNA RECOMMEND
Working in wet conditions. Husqvarna rain clothing. Page 173



H-TEAM RECOMMEND
X-Com R hearing protection. See page 178



SHARE your stories and photos on your Facebook, Instagram and Twitter by tagging us.

-  **HusqvarnaUK**
-  **UK_Husqvarna**
-  **HusqvarnaUK / HusqvarnaGardenUK**

TECHNICAL SPECIFICATIONS

| | 522HD60X | 522HDR60X | 522HDR75X |
|---|----------|-----------|-----------|
| TECHNICAL SPECIFICATIONS | | | |
| Cylinder displacement, cm ³ | 21.7 | 21.7 | 21.7 |
| Power output, kW | 0.6 | 0.6 | 0.6 |
| Sound pressure level at operators ear, dB(A)* | 93 | 93 | 93 |
| Sound power level guaranteed (LWA) dB(A)** | 102 | 102 | 102 |
| Equivalent vibration level (ahv, eq) front /rear handle, m/s ² *** | 2.8/2.1 | 3.8/1.3 | 3.1/2.2 |
| Length cutting equipment, cm | 60 | 60 | 75 |
| Teeth opening, mm | 30 | 30.5 | 30.5 |
| Cutting speed, cuts /min | 4400 | 3200 | 3200 |
| Weight, kg | 4.9 | 5.0 | 5.2 |
| FEATURES | | | |
| Adjustable cutting head | — | — | — |
| Adjustable rear handle | ● | ● | ● |
| Auto-return stop switch | ● | ● | ● |
| Coarse Cut blades | — | ● | ● |
| Fuel pump | ● | ● | ● |
| Low noise engine | — | — | — |
| Low Vib® | ● | ● | ● |
| Rear impact guard | — | — | — |
| Remote control | — | — | — |
| Smart Start® | ● | ● | ● |
| Standalone starter | ● | ● | ● |
| Transport mode | — | — | — |
| X-Torq® engine | — | — | — |

● = Available (●) = Accessory — = Not available *Equivalent sound pressure level at the operator's ear, measured according to EN ISO 11806 and ISO 22868, dB(A). Reported data for equivalent sound pressure level for the machine has a typical statistical dispersion (standard deviation) of 1 dB(A). **Noise emissions in the environment measured as sound power (LWA) in conformity with EC directive 2000/14/EC. Reported sound power level for the machine has been measured with the original cutting attachment that gives the highest level. The guaranteed sound power level includes variation in production as well as variation from the test code with 1–3 dB(A). ***Equivalent vibration levels (ahv, eq) at handles, measured according to EN ISO 11806 and ISO 22867, m/s². Reported data for equivalent vibration level has a typical statistical dispersion (standard deviation) of 1 m/s².

! ALWAYS USE GENUINE HUSQVARNA LUBRICANTS AND SPARE PARTS FOR YOUR HEDGE TRIMMER

These high quality spare parts and lubricants are developed to facilitate the care and maintenance of your Husqvarna equipment and enable trouble-free operation and storage. Husqvarna recommend regular service done by qualified technicians using only Genuine Husqvarna original or recommended spare parts. This will support the product's performance and lifetime. See your owner's manual or consult your Authorised Husqvarna dealer if any uncertainty occurs.

| | 522HS75X | 522HSR75X | 525HE3 | 525HE4 |
|--|----------|-----------|---------|---------|
| | | | | |
| | 21.7 | 21.7 | 25.4 | 25.4 |
| | 0.6 | 0.6 | 1.0 | 1.0 |
| | 93 | 93 | 96 | 93 |
| | 102 | 102 | 106 | 106 |
| | 2.9/1.8 | 2.9/1.8 | 3.1/4.0 | 5.4/2.4 |
| | 75 | 75 | 55 | 55 |
| | 30 | 30.5 | 29 | 29 |
| | 4400 | 3200 | 4300 | 4300 |
| | 5.0 | 5.0 | 6.35 | 6.4 |
| | | | | |
| | — | — | ● | ● |
| | — | — | — | — |
| | ● | ● | ● | ● |
| | — | ● | — | — |
| | ● | ● | ● | ● |
| | — | — | — | — |
| | ● | ● | — | — |
| | — | — | — | ● |
| | — | — | ● | ● |
| | ● | ● | ● | ● |
| | ● | ● | ● | ● |
| | — | — | — | ● |
| | — | — | ● | ● |





BLOW AWAY YOUR HARD WORK

Get rid of leaves, straw, grass, cobwebs, sand, gravel – as well as the hard work. Husqvarna blowers are designed with the user in focus. Efficient and enjoyable to work with and with a range of jobs in-mind, you can be sure these blowers will handle the task effortlessly.



WHAT YOU GET AND HOW WE DO IT



HIGH POWER

Husqvarna blowers – regardless of power source – have high specification engines with optimised power output. The 580BTS delivers an air force of an impressive 40N, whereas the 550iBTX battery blower delivers 21N.



LOW NOISE

Our battery blowers offer very low noise, down to only 76.6 dB(A) on the 550iBTX. This provides a comfortable working situation for you and low disturbance for others when compared to petrol-driven machines. This makes them ideal for work in noise sensitive areas.



LONG SERVICE INTERVALS

The extensive filter area on the large petrol-powered blowers means reduced wear on the blower and longer operating time between filter cleanings.



LOW VIBRATIONS

Effective vibration damping relieves stress on the arms and hands to keep you alert and productive throughout the day.



BLOW OR VACUUM

The 125BVX can easily be turned into vacuum mode, giving you the possibility to efficiently collect debris.





BLOW THE HARD WORK AWAY

BACKPACK BLOWERS MANAGE LARGER AREAS WITH EASE

Husqvarna's backpack blowers are powerful machines that offer the user total control. They are ideal for tackling large areas and long periods of heavy work.

- + Large areas
- + Outstanding blowing power
- + Top ergonomics



The throttle handle on our blowers is positioned to neutralise the lateral forces generated by the air stream and the engine



Cruise control and boost functions are easily set with the intuitive keypad



High air pressure for smooth and efficient cleaning

In-line air outlet



HANDHELD BLOWERS VERSATILE AND EFFICIENT

Perfectly designed for efficient work in smaller to medium sized areas. Our handheld blowers combine high power with great balance, making them perfect for a variety of lighter as well as more demanding tasks. The handheld range includes both battery and petrol-powered blowers.

- + Small-medium sized areas
- + Great manoeuvrability
- + Petrol or battery power

CARE

Find out more on page 163



POWERFUL AND LIGHTWEIGHT BATTERY BLOWERS

They produce no fumes and less noise – and many times they're just as powerful as their petrol-fueled equivalents. An excellent choice for challenging tasks indoors. Our battery blowers also offer low weight and smart features, along with a well-balanced design. Last but not least, they're easy to use: starting and stopping with a single button press on the intuitive keypad.

[Read more about our battery series on page 10.](#)

PRODUCT USE GUIDE

Use this guide to help you select the best product for your needs.

| TYPE OF USE | MODEL | POWER SOURCE | DISPLACEMENT (CM ³) / VOLTAGE | WEIGHT | TYPE | LEAVES, GRASS & HEDGE CLIPPINGS, LITTER AND DEBRIS | | | | | PAGE |
|---|---------|---|---|---------|----------|--|------------|---|---|---|------|
| | | | | | | VACUUM | INDOOR USE |  |  |  | |
| | | | | | | | | LOW DENSITY | MEDIUM DENSITY | LARGE DENSITY | |
|  FULL-TIME USE (PROFESSIONAL) | 525iB |  | 36V Li-ion | 2.4 kg* | Handheld | | ● | ● | ○ | | 110 |
| | 530iBX |  | 36V Li-ion | 2.9 kg* | Handheld | | ● | ● | ● | | 110 |
| | 525BX | Petrol | 25.4 cm ³ | 4.3 kg | Handheld | | | ● | ● | | 111 |
| | 550iBTX |  | 36V Li-ion | 6.3 kg* | Backpack | | ● | ● | ● | ○ | 111 |
| | 350BT | Petrol | 50.2 cm ³ | 10.2 kg | Backpack | | | ● | ● | | 111 |
| | 570BTS | Petrol | 65.6 cm ³ | 11.2 kg | Backpack | | | ○ | ● | ● | 111 |
| | 580BTS | Petrol | 75.6 cm ³ | 11.7 kg | Backpack | | | ○ | ● | ● | 111 |

The product selector is only to be used as a guide. Please visit your local Authorised Husqvarna dealer for more information.

* Excluding battery ● Optimised solution (guideline only) ○ Capable solution but not optimal (guideline only)





BLOWERS



High performance petrol and battery handheld and backpack blowers designed for full-time professional use. With unique fan designs that generate high air velocity and powerful airflow the products are ideal for moving large volumes of dry or wet leaves and debris. Battery powered products are ideal for use in noise sensitive or enclosed spaces.

Ideal for applications including:

- Landscape maintenance
- Parks and public spaces
- Inner city cleaning
- Noise sensitive areas (battery)
- Indoor and enclosed spaces (battery)

525iB

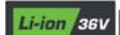

Low weight, handheld battery blower designed for professional use. Weatherproof (IPX4) and low noise, ideal for use in noise sensitive areas.

- 13.3 m³/min, 56 m/s
- Brushless motor
- Cruise control & Boost
- In-line air outlet
- Keypad with savE™
- Weatherproof (IPX4)

| Voltage | Motor type | Vibration levels | Weight |
|-------------------------------------|----------------|----------------------|------------------------|
| 36V Li-ion | BLDC Brushless | 0.5 m/s ² | 2.4 kg (excl. battery) |
| Model | Order PNC | RRP ex VAT | RRP inc VAT |
| 525iB Unit only | 967 91 55-02 | £315.83 | £379.00 |
| Unit + BLi200 & QC330 (recommended) | | £581.66 | £697.99 |

530iBX



High performance ultra low noise battery blower designed for professional use. Backpack battery only and weatherproof (IPX4) for maximum performance.

- 14.1 m³/min, 56.2 m/s
- Brushless motor
- Cruise control & Boost
- 77.6dB(A) noise level
- Keypad with savE™
- Backpack battery use only

| Voltage | Motor type | Vibration levels | Weight |
|--------------------------------------|----------------|----------------------|------------------------|
| 36V Li-ion | BLDC Brushless | 0.4 m/s ² | 2.9 kg (excl. battery) |
| Model | Order PNC | RRP ex VAT | RRP inc VAT |
| 530iBX Unit only | 967 94 14-02 | £357.50 | £429.00 |
| Unit + BLi950X & QC500 (recommended) | | £1,473.33 | £1,767.99 |

WORKING TIME ON ONE CHARGE

525iB / 530iBX*

LIGHT TOUGH



| | | | |
|--|----------------|------------|------------|
| | BLi100 | 15 min | 10 min |
| | BLi200 | 35 min | 15 min |
| | BLi300 | 1 h | 35 min |
| | BLi550X | 1 h 45 min | 45 min |
| | BLi950X | 3 h 30 min | 1 h 45 min |

*530iBX is backpack battery use only



525BX



Powerful, ultra low vibration handheld blower designed for professional use. Special fan and housing design and X-Torq® for high blowing capacity.

- 13 m³/min, 70 m/s
- Smart Start®
- Inline-outlet
- X-Torq®
- Low Vib®
- Cruise Control

| Displacement | Power output | Vibration levels | Weight |
|--------------|-----------------|------------------|----------------|
| 25.4 cm³ | 0.85kW / 1.1 hp | 1.2 m/s² | 4.3 kg |
| Model | Order PNC | RRP ex VAT | RRP inc VAT |
| 525BX | 967 28 42-01 | £290.83 | £349.00 |

350BT



High performance mid range backpack blower designed for professional use in medium density applications.

- 14 m³/min, 80.5 m/s
- Low Vib®
- Offset handle
- X-Torq®
- Ergo harness
- Cruise Control

| Displacement | Power output | Vibration levels | Weight |
|--------------|----------------|------------------|----------------|
| 50.2 cm³ | 1.6kW / 2.2 hp | 2.2 m/s² | 10.2 kg |
| Model | Order PNC | RRP ex VAT | RRP inc VAT |
| 350BT | 965 87 75-01 | £457.50 | £549.00 |

550iBTX

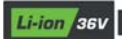

Powerful and ergonomic backpack battery blower for professional use. Extremely low noise and vibration levels and weatherproof (IPX4) giving maximum flexibility and productivity.

- 12.8 m³/min, 546 m/s
- Brushless motor
- Cruise control & Boost
- 76.6dB(A) noise level
- Keypad with savE™
- Backpack battery use only

| Voltage | Motor type | Vibration levels | Weight |
|--------------------------------------|----------------|------------------|-----------------------|
| 36V Li-ion | BLDC Brushless | 0.1 m/s² | 6.3kg (excl. battery) |
| Model | Order PNC | RRP ex VAT | RRP inc VAT |
| 550iBTX Unit only | 967 68 11-02 | £499.17 | £599.00 |
| Unit + BLi950X & QC500 (recommended) | | £1,614.99 | £1,937.99 |

570BTS



High performance professional backpack blower designed for the movement of large volumes of debris spread over large areas.

- 22 m³/min, 106 m/s
- Low Vib®
- Offset handle
- X-Torq®
- Ergo harness
- Cruise Control

| Displacement | Power output | Vibration levels | Weight |
|--------------|----------------|------------------|----------------|
| 65.6 cm³ | 2.9kW / 3.8 hp | 1.8 m/s² | 11.2 kg |
| Model | Order PNC | RRP ex VAT | RRP inc VAT |
| 570BTS | 966 62 94-01 | £582.50 | £699.00 |

WORKING TIME ON ONE CHARGE

550iBTX*

LIGHT

TOUGH



| | | | |
|--|----------------|------------|--------|
| | BLi550X | 50 min | 30 min |
| | BLi950X | 1 h 45 min | 1 h |

*550iBTX is backpack battery use only

580BTS



Our most powerful professional backpack blower designed for movement of the largest volumes of debris spread over large areas.

- 26 m³/min, 92 m/s
- Low Vib®
- Ergo harness
- X-Torq®
- Air Injection™
- Offset handle

| Displacement | Power output | Vibration levels | Weight |
|--------------|----------------|------------------|----------------|
| 75.6 cm³ | 3.1kW / 4.2 hp | 1.6 m/s² | 11.8 kg |
| Model | Order PNC | RRP ex VAT | RRP inc VAT |
| 580BTS | 966 62 96-01 | £624.17 | £749.00 |



TECHNICAL SPECIFICATIONS

| | 525BX | 350BT | 570BTS | 580BTS |
|---|-------|-------|--------|--------|
| TECHNICAL SPECIFICATIONS | | | | |
| Cylinder displacement, cm ³ | 25.4 | 50.2 | 65.6 | 75.6 |
| Power output, kW | 0.85 | 1.6 | 2.9 | 3.1 |
| Sound pressure level at operators ear, dB(A)* | 91 | 94 | 99 | 100 |
| Sound pressure (15 m), dB(A) | 71 | 71 | 76 | 77 |
| Sound power level guaranteed (LWA), dB(A)** | 106 | 104 | 110 | 112 |
| Equivalent vibration level (ahv, eq) handle, m/s ² *** | 1.2 | 2.2 | 1.8 | 1.6 |
| Air speed, m/s | 70.0 | 80.5 | 106 | 92.0 |
| Air flow in housing, m ³ /min | 13.9 | 19.6 | 28.0 | 29.0 |
| Air flow in pipe, m ³ /min | 13 | 14 | 22 | 26 |
| Vac bag capacity, litres | — | — | — | — |
| Weight, kg | 4.3 | 10.2 | 11.2 | 11.8 |
| FEATURES | | | | |
| Adjustable handle | — | ● | ● | ● |
| Air Injection™ | — | — | — | ● |
| Auto-return stop switch | ● | — | — | — |
| Comfort handle | ● | ● | ● | ● |
| Commercial grade air filter | ● | — | ● | ● |
| Cruise control | ● | ● | ● | ● |
| Ergonomic handle | ● | ● | ● | ● |
| Ergonomic harness | — | ● | ● | ● |
| Fuel pump | ● | ● | ● | ● |
| In lined outlet | ● | — | — | — |
| Low Vib® | ● | ● | ● | ● |
| Mulching function | — | — | — | — |
| Smart Start® | ● | — | — | — |
| Vac capable | — | — | — | — |
| X-Torq® engine | ● | ● | ● | ● |

● = Available (●) = Accessory — = Not available *Equivalent sound pressure level at the operator's ear, measured according to EN15503 dB (A). The equivalent sound pressure level value is calculated with a work cycle of a duration of 1/7 for idling and 6/7 for racing. Reported equivalent sound pressure level for the machine has a typical statistical dispersion (standard deviation) of 1 dB(A). **Noise emissions in the environment measured as sound power (LWA) in conformity with EC directive 2000/14/EC. The guaranteed sound power level includes variation in production as well as variation from the test code with 1-3 dB(A). ***Equivalent vibrations levels (ahv, eq) at handles, measured according to EN15503, m/s². The equivalent vibration level value is calculated with a work cycle of a duration of 1/7 idling and 6/7 for racing. Reported data for equivalent vibration level has a typical statistical dispersion (standard deviation of 1 m/s²).

NOMINAL POWER A new machinery directive (2006/42/EC) came into force on January 1, 2010, requiring manufacturers to declare the nominal power of engines, in kilowatts (kW). The power rating of the engines indicated is the average net power output during a normal working situations and meets applicable noise regulations (at specified rpm, see owner manual) of a typical production engine for the engine model measured to SAE standard J 1349/ISO 1585. Mass production engines may differ from this value. Actual power output for the engine installed in the final machine will depend on the operating speed, environmental conditions and other variables.





CUTTERS BUILT FOR YOUR BUSINESS



Husqvarna power cutters and diamond blades are well-known for their high productivity and reliable operation. Regardless if you prefer petrol or battery power, you'll get an optimal mix of high power-to-weight ratio, low vibration levels, ergonomic design and easy maintenance. For best cutting performance, choose a Husqvarna diamond blade optimised for both the machine and the material to be cut.

WHAT YOU GET AND HOW WE DO IT



OPTIMAL PERFORMANCE

The cylinder design and integrated heat deflectors on our petrol-driven power cutters allow for optimal engine performance regardless of variations in climate and fuel.



CONVENIENT DUST CONTROL

Outstanding dust control with minimal water and slurry. Our petrol cutters have a specially-designed water valve allowing for progressive water flow adjustment.



MAXIMUM UPTIME

A user-centric design not only spares your body, it also enables you to stay alert and efficient. This is why our saws are packed with solutions that make your work convenient – and productive.



SMOOTHER STARTING

DuraStarter™ is a virtually maintenance-free starter device featuring a dust-sealed return spring and pulley bearing and a heavy duty starter cord.





K 535i



Battery power cutter designed for lighter concrete jobs. Ergonomic and low weight design makes it ideal for landscapers, pavers and roofers. Thanks to low vibration levels, slim design and centered placement of the blade, you get superior control compared to conventional cutters.

- 230 mm / 9" blade diameter
- Cutting depth 76 mm / 3"
- Electric retarder
- Weatherproof (IPX4)
- Specially developed blades
- Keypad with savE™
- Integrated dust suppression
- Centred blade
- Simple blade change
- Rope eyelet

| Voltage | Motor Type | Vibration levels F/R | Weight |
|-------------------------------------|----------------|----------------------------|-----------------------|
| 36V Li-ion | BLDC Brushless | 2.1 / 2.5 m/s ² | 35 kg (excl. battery) |
| Model | Order PNC | RRP ex VAT | RRP inc VAT |
| K 535i unit only | 967 79 59-01 | £453.00 | £543.60 |
| Unit + BLi200 & QC330 (recommended) | | £718.83 | £862.59 |
| Tacti-Cut S35s 230mm | 596 52 03-01 | £51.00 | £61.20 |

K 770



The Husqvarna K 770 is a powerful all-round power cutter equipped with semi-automatic SmartTension™ system allowing for optimal power transmission, minimum wear and maximum belt life. The light weight, outstanding power-to-weight ratio, reliable start and exceptionally low vibrations mean less strain and maximised productivity.

- X-Torq®
- Active Air Filtration™
- SmartCarb™
- DuraStarter™
- Low Vib®
- SmartTension™
- Supplied with Tacti-Cut S 50 / + blade
- Cutting depth 100 mm (12" / 300 mm)
- Cutting depth 125 mm (14" / 350 mm)

| Displacement | Power output | Vibration levels F/R | Weight |
|----------------------|----------------|---------------------------|-----------------|
| 74 cm ³ | 3.7kW / 5.0 hp | 2.0/ 2.3 m/s ² | 10 / 10.1 kg |
| Model | Order PNC | RRP ex VAT | RRP inc VAT |
| K 770 12" with blade | 967 80 86-01 | £830.00 | £996.00 |
| Tacti-Cut S 50 12" | 579 81 64-11 | £36.00 | £43.20 |
| K 770 14" with blade | 967 68 21-01 | £905.00 | £1086.00 |
| Tacti-Cut S 50+ 14" | 579 81 56-20 | £83.00 | £99.60 |

DIAMOND BLADES FOR CUTTING JOBS IN ALL MATERIALS

In handheld applications, fast and smooth cutting is essential to minimise strain on the user. For maximum work efficiency and cost-effectiveness, we recommend you to choose a blade with the properties that suits the job you are about to do. Husqvarna Elite-Cut diamond blades are developed for professional users with high demands on efficiency. If you need to cut many different materials with the same blade, Husqvarna Vari-Cut is the series for you. Husqvarna Tacti-Cut series consists of diamond blades with balanced performance, developed for occasional cutting.



HUSQVARNA ELITE-CUT FOR FAST CUTTING IN ALL MATERIALS

Superb cutting performance thanks to Diagrip™ technology and innovative segment design for efficient cutting, cooling and slurry evacuation, which increases both cutting speed and service life. Easy-fit blade bushing for bore hole expansion from 20 to 25.4 mm.

HUSQVARNA VARI-CUT FOR ALL-ROUND APPLICATIONS

Vari-Cut blades have good performance and deliver high cutting speed with good service life in frequent all-round use. In this product family there are three versions for cutting in different materials, all clearly indicated on the packaging.

HUSQVARNA TACTI-CUT FOR OCCASIONAL CUTTING IN ALL MATERIALS

Provides good balance between price and performance. Recommended when you cut only occasionally and seek low cost per blade.

FIND OUT MORE POSSIBILITIES

For more information on petrol, electric and battery cutters, accessories and to view the complete Husqvarna construction product range. Please visit www.husqvarnacp.com/uk



THE RIGHT MACHINES AREN'T ALWAYS THE BIGGEST

No two areas of green space are the same. That's why we offer a wide range of equipment – from our high-capacity commercial front mowers, to our efficient walk-behind mowers. By always choosing the right one for the job, you get it done as quickly as possible, and avoid spending unnecessary time on touch-up trimming. And with the addition of our commercial robotic mowers, you might not even have to spend any time at all.

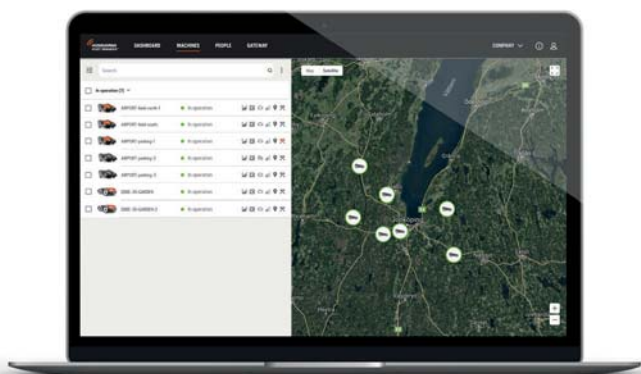

COMMERCIAL ROBOTIC MOWERS

GIVES EVERY LAWN A PERFECT CUT. YOU JUST WATCH IT.

Our professional Automower® robotic mowers come with class-leading terrain performance and slope performance (the Automower® 535 AWD handles an impressive 70%). They can handle passages as tight as 60 cm and deliver an impressive cut quality. And best of all, they work effortlessly 24/7, while you have total control from anywhere – from the office or out in the field – with Husqvarna Fleet Services™. [Learn more on pages 118–133.](#)



COMMERCIAL FRONT MOWERS

**BIG ENOUGH TO DO IT QUICKLY.
AGILE ENOUGH TO DO IT
ANYWHERE.**

No need to leave your seat until you're done. Our commercial front mowers offer the best of two worlds. You get the high capacity you need to mow large green spaces quickly, as well as the agility you need to trim around bushes, fences and park benches, thanks to the articulated steering and low cutting-deck profile. All while delivering fantastic results. [Learn more on pages 134-147.](#)



COMMERCIAL ROBOTIC MOWING



Robotic mowers are the perfect solution for efficient and sustainable management of green spaces and sports turf. With Husqvarna's new EPOS Automower® robotic technology, the mowing possibilities are made even more flexible as the need for boundary and guide is made obsolete. The Automower® 550 EPOS mower works without the need of physical wires and can be remotely programmed via Husqvarna Fleet Services™. And while they tirelessly spend their days producing a carpet-like finish, you can spend your time focusing on other more skilled tasks.



WHAT YOU GET. HOW WE DO IT.

HUSQVARNA FLEET SERVICES™

THE PROFESSIONAL WAY TO MANAGE YOUR ROBOTIC MOWERS

When you invest in our 500 Series robotic mowers, you get free access to Husqvarna Fleet Services™ – a digital tool allowing you to easily monitor and control them from your smart phone, tablet or laptop. Just as easy as it should be.

FILTERS THAT MAKE YOUR MOWERS MORE EFFICIENT

Different mowers can be “tagged” to different teams, or to different locations, and then grouped for easier handling. The different user roles can also be tagged with different levels of control.

ALWAYS KEEP TRACK OF THEIR EXACT LOCATIONS

Want an overview of all your robotic mowers? Just check the map view. Thanks to the built-in GPS, you always know the exact location and status of every robotic mower. Use tags to issue commands to all mowers in specific areas for even easier fleet handling.

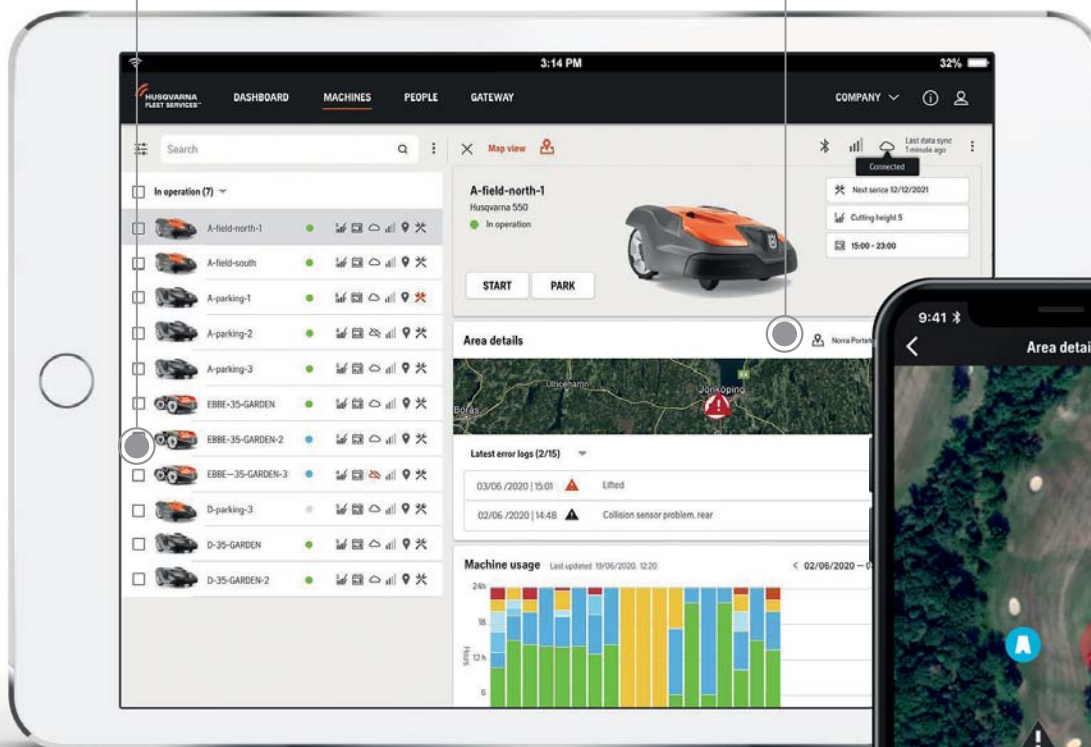

**FREE
10 YEAR
DATA PLAN
INCLUDED**

FULL CONTROL AND SCHEDULING FROM ANYWHERE

Forget manual controls. With Husqvarna Fleet Services™, you – and only you – conveniently control your robotic mowers from anywhere. Perfect when you want to adjust the mowing schedule or cutting height, or park them before the storm arrives. And thanks to tagging, you can exert exact control over all your mowers, grouping them and issuing batch commands, directly from your smartphone app.

+ ALL YOUR EQUIPMENT IN ONE PLACE

If you want to, you can also connect the rest of your equipment to the system by using Husqvarna Fleet Services™ sensors. [Learn more at www.husqvarna.com/uk/fleetservices](http://www.husqvarna.com/uk/fleetservices)

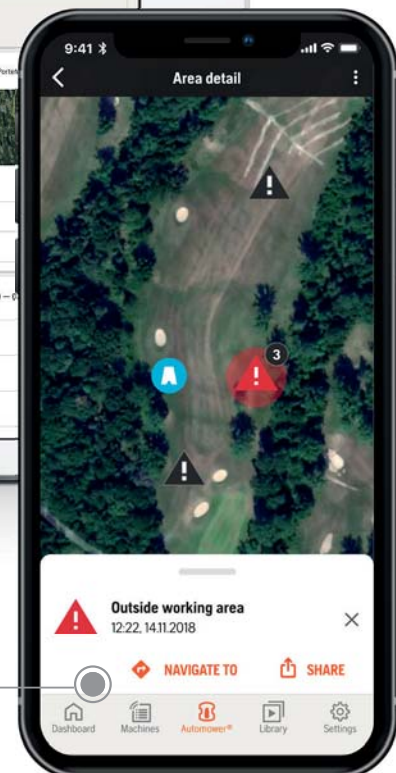

OPERATIONAL INSIGHTS

Should anything happen, such as an unexpected standstill for one mower, you'll immediately receive a notification to your phone. Information about where problems occur and how often give you valuable insights to continuously adjust and improve the installation, which ensure a smooth and efficient operation. Through the Automower® Machine usage tab, you can review daily user data for more insights. The information is summarised in an easy and accessible way, helping you make your fleet usage more efficient and productive.



AUTOMOWER® EPOS HOW IT WORKS

Automower® EPOS is a satellite powered guidance technology for robotic mowing. Satellite signals are received by both the mower and the reference station. To achieve an accuracy of 2-3 cm Real-Time Kinematic Global Navigation Satellite System (RTK-GNSS) is used. A fixed EPOS reference station is required to broadcast precision correction data to the mower. EPOS requires an unimpeded view of the satellites for signal data to be received and correction data to be sent. Tall buildings and dense trees close to or within the installation can block satellite data.



AUTOMOWER® EPOS VIRTUAL BOUNDARIES

Automower® EPOS does not require boundary or guide wires to define the working area. The boundary wire is replaced by a virtual boundary. A virtual "loop signal map" is created when the machine is installed. Up to 3 virtual guides can be used for returning the mower to the charge station and the use of transport paths allows easy movement between designated work areas even on paved surfaces. The mower maintains work areas using a random cutting pattern, GPS ensures even area coverage. Virtual boundaries allow for trouble-free ground maintenance such as aeration.

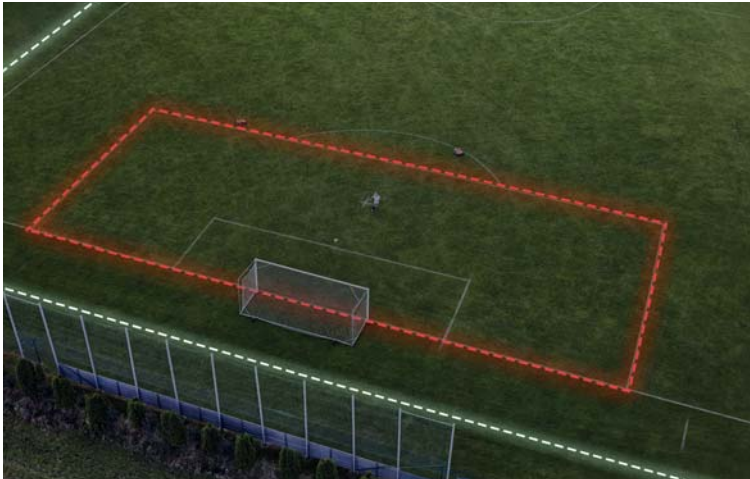

AUTOMOWER® EPOS
PRECISE AREA MANAGEMENT

Automower® EPOS allows precision management of multiple work areas using individual area settings. Work areas can be assigned their own specific mowing schedule as well as cutting height. Temporary stay-out zones can easily be activated and de-activated depending upon the situation. Transport paths are used to move the robotic mower between work areas as well as to and from the charge station. This allows for much more flexible placement of the charging station.

Learn more at www.husqvarna.com/uk

AUTOMOWER® CLUB SOLUTION
IDEAL SOLUTIONS FOR SPORTS FIELDS

Automower® club solution allows for optimum cutting of sports pitches including football and rugby. It has been designed to work with Automower® 550, enabling one single installation for an entire pitch. This means that up to three mowers can run simultaneously in the same area allowing routine maintenance such as aeration and turf repairs to be carried out without the risk of damaging the boundary wire.

Learn more at www.husqvarna.com/uk



COMMERCIAL INTERFACE
HIGH SECURITY PROTECTION

The Automower® 500 series all feature a commercial human machine interface (HMI) specially adapted for use in public settings. The professional HMI, which features a START / STOP switch and LED status indicator protects against unauthorised tampering of the machine and its settings. If the robotic mower gets stolen, it's immediately locked, an alarm goes off and the built-in GPS tracking shows the mower's exact position. All the machines settings and controls are managed remotely through the Husqvarna Fleet Services™ smartphone app or via a PC or tablet.

“Parks and green spaces is an important element of Edinburgh. If we can free up what limited resources we have to look after the borders and plants, it's a winner for everybody because the borders are clean and the grass is still getting cut. It keeps it to a standard that we couldn't keep before”.

Edinburgh City Council





ECONOMY **SPEND LESS.** **GET MORE DONE.**

More time for your workforce to focus on other, more valuable, tasks – and less time spent maintaining grass areas.



BATTERY POWER **REDUCE YOUR FOOTPRINT**

Automower® is electric and virtually silent. This means you can both reduce your environmental impact and let your people work without disturbing anyone.

AVAILABLE 24/7 **WORKING NIGHT AND DAY.** **RAIN OR SHINE.**

Automower® works tirelessly around the clock. It's also weather proof, providing great results even in wet conditions.



SAFETY FEATURES **DESIGNED TO PROTECT AND BE PROTECTED**

Pivoting blades that quickly fold away if they should hit an obstacle, positioned at a safe distance from the outer edge. Lift, tilt and ultrasonic collision sensors, stopping it before any danger occurs. An Automower® robotic mower is packed with safety features. Professional control also protects from unauthorised tampering, and should the mower get stolen, it's immediately locked and rendered useless, the alarm goes off and the built-in GPS allows you to track its position.



TERRAIN / SLOPE PERFORMANCE **HANDLES SLOPES** **AS STEEP AS UP TO 70 %**

Some areas of green space are more difficult than others. Fortunately, Automower® robotic mowers offer market-leading performance in hilly terrain. Our latest all-wheel drive mower is equipped to handle slopes of up to an impressive 70 % (35°) incline, whereas our other models easily handles inclinations of up to 45 %.



TAKING CARE OF BUSINESS. WHEREVER IT'S NEEDED.

Husqvarna Automower® robotic mowers are a highly flexible addition. Thanks to their broad application range, they present a solution to a wide number of lawn tending needs. Landscapers, municipalities, sports clubs, facility managers or general greencare professionals will all be able to benefit from everything from the perfect results and the impressive slope performance to the chance to save on both time and equipment costs.



FACILITY MANAGERS ADDING VALUE FOR YOUR CUSTOMERS AND YOUR BUSINESS

Working as a facility manager means that you often face a wide number of varying tasks throughout the workday. Handing over the lawn care part of the workload to a robotic mower reduces the overall investment costs while freeing up time to focus on other more labour intensive tasks. A robotic mower will help you create beautiful, healthy grass areas that makes both the area in your care and your business look good, while requiring a minimum time for management.



LANDSCAPERS THE BEST SOLUTION FOR THE GREAT WIDE OPEN

Landscapers and greencare professionals in charge of wide stretches of lawns – like parks – are often subject to restrictions and regional regulations regarding emissions and/or noise. Using a number of Automower® robotic mowers will take care of huge areas, delivering perfect results while helping you achieve sustainability goals. Connecting your robotic mowers to Husqvarna Fleet Services™ will further assist you in staying in control and planning for high and low seasons.



SPORTS FIELDS AND GOLF COURSES HEAVY USE, HEAVY DEMANDS

A golf course or sports field, be it for soccer or athletics, is often heavily used and the grass requires extra tending and care. The maintenance can often be difficult, and the need for fertilising, watering and minute care can be both expensive and time-consuming. An Automower® robotic mower works according to your schedule so as not to interfere, and cuts the grass every day or night, adding small composting clippings which don't need collecting. These clippings serve as natural fertiliser that strengthen the grass.



MUNICIPALITIES TOWARDS A GREENER CITY

In most cities and urban areas, there are rules for emissions. Thanks to its significantly lowered CO₂ emissions, using Husqvarna Automower® will help lower the overall footprint substantially. The moderate equipment costs and minimum labour needs makes it a beneficial solution for professionals employed by municipalities. Replacing manual mowing of steep slopes with robotic mowing using Husqvarna Automower® 535 AWD also eliminates the risk of accidents on slopes.





HOW IT WORKS!

Cutting little and often, leads to more efficient cutting and healthier grass.

**THE
WORLD LEADER
IN ROBOTIC
MOWING**

PRINCIPAL FUNCTION

- + Unattended mowing.
- + Mow little but efficiently and frequently.
- + Good performance even in wet weather.
- + More free time

COLLISION AND LIFT SENSORS

Collision and lift sensors increases safety. When the mower gently bumps in to an object it will reverse, turn and choose another direction. If it is lifted the blade and mower will stop immediately.

NAVIGATION - NON EPOS

- + The boundary and guide wires are pegged to the lawn or buried just below the surface. A pegged wire disappears into the lawn in a few weeks.
- + The mower stays inside the boundary wire laid around the perimeter of the working area.
- + The charging station transmits a signal around the boundary wire ensuring the mower stays within the working area. The boundary wire can also guide the mower to the charge station.

IRREGULAR MOVEMENT PATTERN

- + No need for specific programming.
- + Covers all parts even if the lawn is complex and/or contains trees, flowerbeds, passages, etc.
- + Allows the grass to get cut from different directions. Creates a smooth carpet-like surface.



TRADITIONAL VS AUTOMATIC MOWING TECHNIQUE

The principal function of the Husqvarna Automower® provides the service of a well cut lawn, not just a lawn mower. Things like horsepower, cutting width and technical details become less important with a Husqvarna Automower® that cuts your grass areas in, and day out.



RECHARGING

When it's time to recharge, the mower finds the charger by one of three methods.

1. By picking up a signal from the charge station antenna.
2. By following the patented guide wire system back to the charging station.
3. By following the boundary until within reach of the home signal.

EFFICIENT CUTTING TECHNIQUE

- + The grass is cut with three fine, razor-sharp blades.
- + The three free-hanging blades are mounted on a disc and are easily replaced.
- + The blades can rotate back into the disc to minimise damage, should they hit hard objects – stone, branches, etc.
- + The grass mown is so fine and small that it does not need to be collected.

HOW TO CALCULATE THE LAWNS INCLINATION?

1. Place one end of a spirit level on the ground, and hold it horizontally.
2. Measure the distance down to the ground from the end of the level in the air. This distance divided by the length of the level is the inclination in %. If the measurement is 10 cm and the length of the level 50 cm the inclination is 20%.

MOWING CYCLE

- + The concept is to keep short grass short.
- + Husqvarna Automower® finds the charging station automatically.
- + Charges for approximately 60 minutes.
- + Resumes mowing, day in and day out regardless of the weather (except snow).

UNSURPASSED CUTTING RESULT

Husqvarna Automower® uses razor-sharp blades to cut every blade of grass, resulting in a lush, green lawn that conventional blades cannot achieve. The grass clippings become a natural fertiliser, helping keep grass areas lush, green and moss free.

! TO FIND OUT MORE AND TO SEE THE HUSQVARNA AUTOMOWER® IN ACTION PLEASE VISIT:



[WWW.YOUTUBE.COM/HUSQVARNAUK](https://www.youtube.com/husqvarnauk)



[@HUSQVARNAUK](https://www.instagram.com/husqvarnauk)





PRODUCT USE GUIDE

Use this guide to help you select the best product for your needs.

| AUTOMOWER® SERIES | AUTOMOWER® MODEL | MAXIMUM WORKING AREA | AREA PER HOUR | MAXIMUM INCLINE | GUIDANCE | | | |
|------------------------------------|--------------------------------|----------------------------|---------------------|--------------------|------------------|--------------------|--------------------------|--------------------|
| | | | | | SEARCH SYSTEM | BOUNDARY SYSTEM | GUIDE WIRES | AREA COMPLEXITY |
| 500 SERIES (COMMERCIAL) | AUTOMOWER® 520 | 2.200 m ² | 90 m ² | 45% / 24.5° | Pentasearch | Wire | 3 | ●●●●● |
| | AUTOMOWER® 535 AWD | 3.500 m ² | 145 m ² | 70% / 35° | Pentasearch | Wire | 3 | ●●●●● |
| | AUTOMOWER® 550 | 5.000 m ² | 210 m ² | 45% / 24.5° | Pentasearch | Wire | 3 | ●●●●● |
| | AUTOMOWER® 550 EPOS | 5.000 m ² | 210 m ² | 45% / 24.5° | RTK-GNSS | Virtual | EPOS Guidance | ●●●●●+ |

The product selector is only to be used as a guide. Please visit your local Authorised Husqvarna dealer for more information.
 ○ - Capable solution but not optimal (guideline only)



| CONNECTIVITY & CONTROL | | | | | | SMART HOME ECO SYSTEM | | | | APPLICATIONS | | | PAGE |
|---------------------------------|-----------------------|--------------------|--|------------------|---|------------------------|-----------------------------|-------|----------|--------------|----------------|----------------|------|
| AUTOMOWER® CONNECT @ HOME | AUTOMOWER® CONNECT | FLEET SERVICE™ | HIGH SECURITY COMMERCIAL INTERFACE | CLUB SOLUTION | | GARDENA smartsystem | amazon alexa Google HOME | IFTTT | | | | | |
| | | | | | | | | | | | | | |
| 30 METRE RANGE | UNLIMITED RANGE | UNLIMITED RANGE | | | | GARDENA | SMART SPEAKERS | IFTTT | OPEN API | DOMESTIC | GROUND CARE | SPORTS TURF | |
| • | • | • | • | | • | • | • | • | • | ○ | • | • | 128 |
| • | • | • | • | | • | • | • | • | • | ○ | • | • | 128 |
| • | • | • | • | • | • | • | • | • | • | ○ | • | • | 129 |
| • | • | • | • | | • | • | • | • | • | ○ | • | • | 129 |

FREE 10
YEAR DATA
PLAN
INCLUDED





500 SERIES – COMMERCIAL USE



Husqvarna robotic mowers specifically developed for commercial applications. Offering the most efficient and sustainable way to consistently maintain areas of green space. Ideal for professionals and private or public enterprises who seek new ways to maintain grassed areas whilst enabling the redeployment of resources onto more important tasks. The 500 Series robotic mowers all come with Husqvarna Fleet Services™ built-in, enabling fleet management and mower control from anywhere.

Ideal for applications including:

- Grounds maintenance
- Sports facilities
- Commercial properties
- Holiday parks
- Noise sensitive areas
- Slopes up to 70% (35°)
- Multiple machines per installation
- Complex areas with obstacles
- Night time mowing

AUTOMOWER® 520



Professional robotic mower with robust design and high cutting capacity. Equipped with commercial interface for simplified and robust interaction. Remote mower management and surveillance through Husqvarna Fleet Services™.

- Husqvarna Fleet Services™
- Automower® Connect fitted
- Commercial interface
- Automatic passage handling
- GPS assisted navigation
- Anti-theft alarm and GPS tracking
- Electric height adjustment
- Lift & tilt sensors
- Weather timer

| Working Area | Area per hour | Maximum incline | Area Complexity |
|----------------------|-------------------|-----------------|-------------------|
| 2,200 m ² | 90 m ² | 45% / 24.5° | ● ● ● ● ● |
| Cutting height | Noise level | Search system | Power consumption |
| 20 - 60 mm | 59dB(A) | Pentasearch (5) | 30W |
| Model | Order PNC | RRP ex VAT | RRP inc VAT |
| Automower® 520 | 967 66 21-03 | £2,249.17 | £2,699.00 |

AUTOMOWER® 535 AWD



Professional AWD robotic mower with high cutting capacity and 70% slope performance. Equipped with commercial interface for simplified and robust interaction. Remote mower management and surveillance through Husqvarna Fleet Services™.

- Husqvarna Fleet Services™
- Automower® Connect fitted
- Commercial interface
- Automatic passage handling
- Ultrasonic collision sensors
- Anti-theft alarm and GPS tracking
- Electric height adjustment
- Lift & tilt sensors
- All wheel drive

| Working Area | Area per hour | Maximum incline | Area Complexity |
|----------------------|--------------------|-----------------|-------------------|
| 3,500 m ² | 145 m ² | 70% / 35° | ● ● ● ● ● |
| Cutting height | Noise level | Search system | Power consumption |
| 30 - 70 mm | 62dB(A) | Pentasearch (5) | 40W |
| Model | Order PNC | RRP ex VAT | RRP inc VAT |
| Automower® 535 | 967 85 34-03 | £3,832.50 | £4,599.00 |



AUTOMOWER® 550



Professional robotic mower with a high cutting speed and large area capacity. Equipped with commercial interface for simplified and robust interaction. Remote control and surveillance through Husqvarna Fleet Services™.

- Husqvarna Fleet Services™
- Automower® Connect fitted
- Commercial interface
- Automatic passage handling
- GPS assisted navigation
- Anti-theft alarm and GPS tracking
- Electric height adjustment
- Lift & tilt sensors
- Weather timer

| Working Area | Area per hour | Maximum incline | Area Complexity |
|----------------------|--------------------|-----------------|-------------------|
| 5.000 m ² | 210 m ² | 45% / 24.5° | ● ● ● ● ● ● |
| Cutting height | Noise level | Search system | Power consumption |
| 20 - 60 mm | 61dB(A) | Pentasearch (5) | 35W |
| Model | Order PNC | RRP ex VAT | RRP inc VAT |
| Automower® 550 | 967 65 02-03 | £3,332.50 | £3,999.00 |

AUTOMOWER® 550 EPOS NEW SPRING EPOS



Professional robotic mower featuring Husqvarna EPOS guidance with precision area management and transport paths. With virtual boundaries you can define several work areas with different settings as well as set temporary stay-out zones. Requires EPOS reference station

- Husqvarna EPOS Technology
- Virtual boundary and guides
- Transport paths
- Electric height adjustment
- Weather timer
- RTK-GNSS Guidance
- Precise area management
- Husqvarna Fleet Services™
- Lift & tilt sensors

| Working Area | Area per hour | Maximum incline | Area Complexity |
|----------------------|--------------------|-----------------|-------------------|
| 5.000 m ² | 210 m ² | 45% / 24.5° | ● ● ● ● ● ● + |
| Cutting height | Noise level | Search system | Power consumption |
| 20 - 60 mm | 61dB(A) | EPOS Guidance | 35W |
| Model | Order PNC | RRP ex VAT | RRP inc VAT |
| Automower® 550 EPOS | 970 46 53-03 | £4,332.50 | £5,199.00 |

EPOS REFERENCE STATION NEW SPRING EPOS



Transmits RTK-GNSS signals between the Automower® 550 EPOS mower and guidance satellites. The mains powered reference station is required for EPOS to function and can serve multiple EPOS units per installation. Work area up to 500 metre radius.

| Model | Order PNC | RRP ex VAT | RRP inc VAT |
|----------------|--------------|------------|------------------|
| EPOS Reference | 970 46 82-03 | £915.83 | £1,099.00 |

HUSQVARNA FLEET SERVICES™

With 10 years free connectivity, the digital tool allows you to easily monitor and control your robotic mower fleet from your smart phone, tablet or laptop. Just as easy as it should be. Find out more on page 158.



LET OUR EXPERTS TAKE CARE OF YOU

Dealer Installation Service

Husqvarna recommend for maximum convenience and to ensure correct installation and trouble-free operation that your local Authorised Husqvarna dealer carries out the product installation. For more information and to locate your nearest dealer please visit:

www.husqvarna.com/uk/dealer-locator

AUTOMOWER® FAIRWAY KIT

Reduces the minimum cutting height allowing a minimum grass length of approximately 10mm to be achieved. Lower range includes 10mm, 12.5mm, 15mm and 17.5mm steps. Excludes Automower® 535 AWD.



| Model | Order PNC | RRP ex VAT | RRP inc VAT |
|-------------|--------------|------------|---------------|
| Fairway Kit | 597 49 63-02 | £12.49 | £14.99 |



INSTALLATION AND PRODUCT ACCESSORIES





BOUNDARY WIRE PRO

High performance 5.5mm diameter boundary wire. The wire features double insulation to deal with the toughest of installations whilst helping to protect against rodents. The outer layer has high UV resistance increasing durability. Length 300m.



| Item | Order PNC | RRP ex VAT | RRP inc VAT |
|--------------------------|--------------|------------|----------------|
| Wire PRO, 300m (Ø5.5 mm) | 593 29 77-02 | £207.50 | £249.00 |

CONNECTORS AND FASTENERS

| Item | Order PNC | RRP ex VAT | RRP inc VAT |
|--|--------------|------------|---------------|
|  Connector, 1pc | 535 12 90-01 | £1.66 | £1.99 |
| Connector, 5pc | 577 86 48-01 | £6.66 | £7.99 |
| Coupler, 1pc | 501 98 02-01 | £1.66 | £1.99 |
|  Coupler, 5pc | 577 86 47-01 | £6.66 | £7.99 |
| Coupler, 100pc | 501 98 02-03 | £54.16 | £64.99 |
|  Peg, 100pc | 577 86 42-01 | £12.49 | £14.99 |

AUTOMOWER® INSTALLATION KITS

SMALL - Suitable for open lawn areas of max 800 m² or complex lawn areas of max 400 m²

MEDIUM - Suitable for open lawn areas of max 2,000 m² or complex lawn areas of max 1,000 m²

LARGE - Suitable for open lawn areas of max 5,000 m² or complex lawn areas of max 2,500 m²



| Item | Order PNC | RRP ex VAT | RRP inc VAT |
|--------|--------------|------------|----------------|
| Small | 967 97 21-01 | £70.83 | £84.99 |
| Medium | 967 97 22-01 | £116.66 | £139.99 |
| Large | 967 97 23-01 | £182.50 | £219.00 |

PROTECTION BOXES

**NEW
SUMMER**

Protection box is a small sealed box for cable connectors, to protect them against moisture during off season.

Outdoor power box is a sealed box to protect an outdoor mounted transformer.



| Item | Order PNC | RRP ex VAT | RRP inc VAT |
|-------------------|--------------|------------|---------------|
| Protection Box | 599 80 17-01 | £8.33 | £9.99 |
| Outdoor Power Box | 599 80 18-01 | £20.83 | £24.99 |

BOUNDARY WIRE

Standard 2.7mm wire used to define the working area, suitable for most installations. Heavy duty 3.4mm wire is a robust wire for demanding installations, 100% copper core and isolated surface to minimise signal loss. All variants feature a black outer layer with high UV resistance.



| Item | Order PNC | RRP ex VAT | RRP inc VAT |
|---------------------------------|--------------|------------|----------------|
| Wire, 50m (Ø2.7 mm) | 597 23 78-02 | £24.99 | £29.99 |
| Wire, 150m (Ø2.7 mm) | 597 23 78-01 | £66.66 | £79.99 |
| Wire, 250m (Ø2.7 mm) | 580 66 20-06 | £99.99 | £119.99 |
| Wire, 800m (Ø2.7 mm) | 580 66 20-09 | £265.83 | £319.00 |
| Heavy duty wire, 500m (Ø3.4 mm) | 522 91 41-02 | £257.50 | £309.00 |

HYBRID GRASS

NEW



Hybrid grass provides grip in narrow and steep areas. Reduces lawn wear on slopes or narrow passages. 1m² hybrid grass including 16 green pegs

| Item | Order PNC | RRP ex VAT | RRP inc VAT |
|--------------|--------------|------------|---------------|
| Hybrid Grass | 598 89 60-01 | £29.16 | £34.99 |



TEMPORARY FENCE



Robust steel arches for temporarily fencing off areas of the lawn. Ideal for protecting spring flowers. 12 arches providing 1m² coverage.

| Item | Order PNC | RRP ex VAT | RRP inc VAT |
|-----------------|--------------|------------|---------------|
| Temporary Fence | 597 98 70-01 | £29.16 | £34.99 |

AUTOMOWER® BLADES

Husqvarna Automower® carbon steel safety blade. Combines high- strength properties and sharpness for a long lifetime.



| Item | Order PNC | RRP ex VAT | RRP inc VAT |
|------------------|--------------|------------|---------------|
| Blades - 9 pack | 577 86 46-03 | £14.99 | £17.99 |
| Blades - 45 pack | 577 60 65-05 | £66.66 | £79.99 |

HOUSING



Protects the charging station and your Husqvarna Automower® from exposure to sun and rain.

| Item | Order PNC | RRP ex VAT | RRP inc VAT |
|----------------|--------------|------------|----------------|
| 500 Series AWD | 597 63 53-01 | £141.66 | £169.99 |

WALL HANGER



Store your Husqvarna Automower® on the wall when not in use and during the winter season.

| Item | Order PNC | RRP ex VAT | RRP inc VAT |
|------------------------|--------------|------------|---------------|
| 500 Series Wall Hanger | 585 01 97-02 | £41.66 | £49.99 |

BOUNDARY REPAIR KIT NEW



Designed to replace a damaged section of boundary wire. Kit includes 5 metres of boundary wire. (Ø2.7 mm) 10 pegs, and 6 connectors.

| Item | Order PNC | RRP ex VAT | RRP inc VAT |
|---------------------|--------------|------------|---------------|
| Boundary Repair Kit | 597 53 95-01 | £10.83 | £12.99 |

AUTOMOWER® ENDURANCE BLADES

Husqvarna Automower® Endurance blades providing more than twice the lifetime compared to our original blades thanks to the unique design. New HSS Blades provide increased durability with High speed steel construction, ideal for commercial applications.



| Item | Order PNC | RRP ex VAT | RRP inc VAT |
|--|--------------|------------|----------------|
| Endurance - 6 pack | 595 08 44-01 | £19.16 | £22.99 |
| Endurance - 45 pack | 595 08 44-02 | £99.99 | £119.99 |
| NEW Endurance HSS - 6 pack | 599 80 52-01 | £23.33 | £27.99 |
| NEW Endurance HSS - 45 pack | 599 80 52-02 | £141.66 | £169.99 |

MAINTENANCE & CLEANING KIT



Including specific slim brushes with sharp scrapers to get in tight areas, a screwdriver to exchange blades, abrasive pad to clean the electric contacts on the mower and charging station and a plastic care spray.

| Item | Order PNC | RRP ex VAT | RRP inc VAT |
|----------------------------|--------------|------------|---------------|
| Maintenance Kit | 590 85 51-01 | £24.99 | £29.99 |
| Care and Shine Spray 200ml | 593 96 79-01 | £9.99 | £11.99 |

FAIRWAY KIT



Lowers the minimum cutting height to 10 mm. Makes it possible to mow the fairways of golf courses, and similar sports turf. Excludes AWD models.

| Item | Order PNC | RRP ex VAT | RRP inc VAT |
|--------------------|--------------|------------|---------------|
| 500 series (>2020) | 597 49 63-01 | £20.83 | £24.99 |
| 500 series (2020>) | 597 49 63-02 | £12.49 | £14.99 |





ROUGH TERRAIN KIT



Provides excellent traction on rough and sloping lawns with slope performance increasing by 5%. Contains course threaded wheels and wheel brushes.

| Item | Order PNC | RRP ex VAT | RRP inc VAT |
|----------------|--------------|------------|---------------|
| 500 Series Kit | 581 88 97-02 | £66.66 | £79.99 |

WHEEL BRUSH KIT



Keeps the driving wheels clean to maintain good traction. Separate replacement refill brushes available.

| Item | Order PNC | RRP ex VAT | RRP inc VAT |
|----------------|--------------|------------|---------------|
| 500 Series Kit | 581 90 31-02 | £29.16 | £34.99 |

REPLACEABLE TOP COVERS



Make your mower unique and personal by changing its colour. Available in white, orange and grey on selected models.

| Item | Order PNC | RRP ex VAT | RRP inc VAT |
|------------------|--------------|------------|---------------|
| 520 - Grey | 591 49 60-01 | £74.99 | £89.99 |
| 520 - Orange | 591 49 60-02 | £74.99 | £89.99 |
| 550 - Grey | 591 49 61-01 | £74.99 | £89.99 |
| 550 - Orange | 591 49 61-02 | £74.99 | £89.99 |
| 535 AWD - Grey | 596 30 02-01 | £74.99 | £89.99 |
| 535 AWD - Orange | 596 30 02-02 | £74.99 | £89.99 |

AUTOMOWER® ACCESSORIES GUIDE

Use this chart below to select the right accessories for your Husqvarna Automower®.

| Husqvarna Automower® Accessory | PNC | 520 | 535 AWD | 550 | 550 EPOS |
|--------------------------------|--------------|----------|---------|----------|----------|
| Replaceable Top Cover | 591 49 60-XX | ● | – | – | – |
| Replaceable Top Cover | 591 49 61-XX | – | – | ● | – |
| Replaceable Top Cover | 596 30 02-XX | – | ● | – | – |
| Housing | 585 01 94-01 | ● | – | ● | – |
| Housing | 597 63 53-01 | – | ● | – | – |
| Bag | 522 91 67-01 | ○ | – | ○ | – |
| Wall Hanger | 585 01 97-02 | ● | – | ● | ● |
| Fairway Kit (>2020) | 597 49 63-01 | ● | – | ● | – |
| Fairway Kit (2020>) | 597 49 63-02 | ● | – | ● | ● |
| Rough Terrain Kit | 581 88 97-02 | S | – | S | S |
| Wheel Brush Kit | 581 90 31-02 | S | – | S | S |
| Wheel Brush Kit | 505 13 28-03 | – | ● | – | – |
| Wheel Brush Refill | 581 98 20-02 | ● | – | ● | ● |
| Automower® Blades | 577 86 46-XX | ● | ● | ● | ● |
| Endurance Blades | 595 08 44-XX | ● | ● | ● | ● |
| Endurance HSS Blades | 599 80 52-XX | ● | ● | ● | ● |
| Replacement Battery | 580 68 33-01 | ● | – | – | – |
| Replacement Battery | 588 14 64-01 | – | – | ● | – |
| Replacement Battery | 593 24 71-01 | – | ● | – | – |

● Designed to fit – Does not fit ○ Fits but not optimal **S** Comes as standard



TECHNICAL SPECIFICATIONS

| | AUTOMOWER® 520 | AUTOMOWER® 535 AWD | AUTOMOWER® 550 | AUTOMOWER® 550 EPOS |
|---|-----------------------|-----------------------|-----------------------|------------------------|
| TECHNICAL SPECIFICATIONS | | | | |
| Working area capacity, m ² (+/- 20%) | 2200 | 3500 | 5000 | 5000 |
| Area capacity per hour, m ² | 90 | 145 | 208 | 208 |
| Maximum daily operating time, h | 24 | 24 | 24 | 24 |
| Maximum slope capacity, inside / by edge, % | 45 / 15 | 70/50 | 45 / 15 | 45 / 15 |
| Charging current, A | 2.2 | 7.0 | 7.0 | 7.0 |
| Navigation system and starting points | Irregular /5 | Irregular /5 | Irregular /5 | Irregular |
| Number of guides, pcs | 3 | 3 | 3 | Virtual guides (3) |
| Charging system | Automatic | Automatic | Automatic | Automatic |
| Search system | Pentasearch | Quadsearch | Pentasearch | EPOS Guidance |
| Brushless drive motor type | Ultrasilent drive, DC | Ultrasilent drive, DC | Ultrasilent drive, DC | Ultrasilent drive, DC |
| Brushless blade motor type | 3-phase, DC | 3-phase, DC | 3-phase, DC | 3-phase, DC |
| Battery type | Li-ion | Li-ion | Li-ion | Li-ion |
| Battery capacity, Ah | 3.2 | 5 | 10.4 | 10.4 |
| Battery voltage, V | 18 | 18 | 18 | 18 |
| Power consumption during cutting, W | 30 | 40 | 35 | 35 |
| Cutting width, cm | 24 | 22 | 24 | 24 |
| Cutting height, min-max, mm | 20-60 | 30-70 | 20-60 | 20-60 |
| Sound level, dB(A) (measured / guaranteed)* | 58 / 59 | 60 / 62 | 60 / 61 | 60 / 61 |
| Extra blades, pcs | 6 | 6 | 6 | 6 |
| Weight, kg | 11.5 | 17.0 | 13.5 | 14.2 |
| FEATURES | | | | |
| All-Wheel Drive | – | ● | – | – |
| Anti-theft alarm | ● | ● | ● | ● |
| Automatic passage handling | ● | ● | ● | ● |
| Automower® Connect@HOME | ● | ● | ● | ● |
| Automower® Access | – | – | – | – |
| Husqvarna Fleet Services™ | ● | ● | ● | ● |
| Backlit communication display | ● | ● | ● | ● |
| Backlit keypad | ● | ● | ● | ● |
| Easy clean - hose washable | – | – | – | – |
| Electric height adjustment | ● | ● | ● | ● |
| Frost sensor | – | – | – | – |
| FOTA – software update automatically | – | ● | – | ● |
| GPS theft tracking | ● | ● | ● | ● |
| Husqvarna EPOS Technology | – | – | – | ● |
| EPOS Reference Station | – | – | – | (●) |
| GPS-assisted navigation | ● | ● | ● | ● |
| LED headlights | – | – | – | ● |
| Lift and tilt sensor | ● | ● | ● | ● |
| Precise area management | – | – | – | ● |
| PIN code lock | ● | ● | ● | ● |
| Professional control | ● | ● | ● | ● |
| Profiles | ● | ● | ● | ● |
| Remote object detection | – | ● | ● | ● |
| Automower® Club solution | – | – | ● | – |
| Spot cutting | ● | ● | ● | ● |
| Spiral cutting | ● | ● | ● | ● |
| Tilt sensor | ● | ● | ● | ● |
| Ultrasonic sensor | – | ● | ● | ● |
| Weather timer | ● | ● | ● | ● |
| ACCESSORIES AVAILABLE | | | | |
| Automower® Connect | ● | ● | ● | ● |
| Fairway kit | (●) | – | (●) | (●) |
| Front head lights | – | – | – | ● |
| Housing | (●) | (●) | (●) | – |
| Rough terrain kit | ● | – | ● | ● |
| Soft carry bag | (●) | – | (●) | – |
| Wall hanger | (●) | – | (●) | (●) |
| Wheel brush kit | ● | – | ● | ● |
| Body colour options | (●) | (●) | (●) | – |

● = Available (●) = Accessory – = Not available

*Noise emissions in the environment measured as sound power (LWA) in conformity with EC directive 2000 / 14 / EC. The guaranteed sound power level includes variation in production as well as variation from the text code with 1-3 dB(A)



GET THE JOB DONE QUICKLY, WELL AND ANYWHERE



High power and extreme versatility in a compact, durable format. That's the winning formula behind the commercial-grade front mowers from Husqvarna. With their efficient cutting decks and a wide range of useful attachments, these agile machines will help increase your daily turnover all year round, whether you prefer diesel, petrol or hybrid technology.



WHAT YOU GET. HOW WE DO IT.

SUPERIOR MANOEUVRABILITY

The articulated steering system allows the rear pair of wheels to swing in underneath the machine. The result is superior manoeuvrability with a minimum turning radius at full lock. The compact size together with the articulated steering makes it easy to manoeuvre the machine in narrow spaces and tricky areas.



EXCELLENT ACCESSIBILITY AND CONTROL

The front-mounted cutting decks give excellent overview of the working area, enabling precise, close-up trimming. The off-set design of the cutting Combi 155 / X enables easy handling of corners and trimming against walls and fences, while the low profile gives unbeatable accessibility in under fences, bushes, park benches etc.

ALL-TERRAIN DRIVING PERFORMANCE

All-Wheel Drive (AWD) ensures traction on uneven, wet and slippery areas and slopes. The machine's low centre of gravity in combination with the high-performing AWD-system gives excellent slope and hillside stability. AWD automatically adjusts the traction on all wheels depending on situation and ground condition. Equipped with high-specified variable piston pumps with separate gear boxes for the front and rear axle. The Hybrid P 535HX uses individual electric wheel motors with traction control for maximum performance in even the most demanding conditions.





REDUCE FOLLOW-UP TRIMMING – SAVE TIME AND MONEY

Studies* show that large-scale commercial mowers only mow about 65% of the total area of the areas they work on. The remaining 35% has to be taken care of later, using a walk-behind mower or a trimmer. The result is markedly lower productivity and more expensive labour costs. And in the end, reduced profitability. The reason for this is that most commercial Ride-on mowers aren't designed for the complex lawn shapes that professional landscapers have to deal with on a daily basis. The exception is our 500 series of compact front mowers. These machines offer lots of smart solutions that reduce the amount of follow-up trimming to 20%. Which means you finish the job earlier and can be on the way to the next one.



* Studies comparing the mowing productivity of a rear-wheel steered front mower equipped with 155 cm cutting deck versus a Husqvarna P 500 equipped with 132 cm cutting deck, carried out during a full cutting season.

EFFICIENT ERGONOMICS MAXIMISE PRODUCTIVITY

Our commercial front mowers are equipped with ergonomic operator's interface for a comfortable ride during long working hours. Controls are easily accessible and designed for optimum user comfort. The heavy-duty hydraulic-cylinder power steering makes driving less strenuous. Large wheels both front and back provide optimal riding comfort, great accessibility and less risk of damaging delicate surfaces.



BUILT FOR YEARS OF COMMERCIAL USE

The rigid, reinforced heavy-duty steel ladder frame has an open design for excellent serviceability. For improved durability the complete rear wagon is in one piece ductile cast iron. The high-performance Combi cutting decks are stamped from a single piece of steel plate and has durable, flat-free support wheels with air-filled core to provide good dampening and smooth operation with maximum uptime.



VERSATILE ALL-SEASON USAGE

A wide range of cutting decks and attachments will make your front mower exceptionally versatile, all year round. The smart quick coupling allows attachments to be changed quickly and efficiently with a minimum of standard tools. Equipped with solid and hardened PTO shaft for maximum efficiency and durability. Husqvarna P 525DX is also available in a cabin-equipped version.



ACCESSIBLE SERVICE POINTS FOR EASY MAINTENANCE

The tilting hood and easy-access servicing points make the daily maintenance checks and servicing easy. The cutting deck features greasable mandrels that are easy to reach from above, while the service position facilitates cleaning and service under the cutting deck.



CUTTING DECKS COMBINING EFFICIENCY AND EXCELLENT CUTTING RESULT

The R180 rear discharge cutting deck utilises the hybrid power of the P 535HX to maximise the mowing capacity. The Combi 132 and 155 cutting decks (available for Husqvarna P 535HX, P 525DX and P 520D) can be used for both BioClip® (mulching) and rear discharge. The deck shell has been stamped out of one solid piece of steel, allowing for an optimised airflow, which is the main reason for the high efficiency. The Combi decks are made from 4.5 mm steel and are equipped with replaceable side skid wears, for a long and reliable product life.



ELECTRONIC FUEL INJECTION MORE POWER – LESS FUEL AND EMISSIONS

The P 524EFI is equipped with electronic fuel injection (EFI). Thanks to the efficient combustion, it delivers the additional power and torque you need to maintain a higher speed in uneven terrain. It also contributes to lower fuel consumption and less emissions. Starting is easy too, since there's no need for a manual choke. Just turn the key and go.



COMMERCIAL FRONT MOWERS



P 524Efi



Compact commercial petrol-machine that offers excellent manoeuvrability in complex areas. The electronic fuel injection (EFI) increases power and torque, while lowering fuel consumption and emissions. It also makes starting easy by eliminating the need for a manual choke.

- Powerful 2-cylinder Kawasaki EFI engine.
- Unique articulated steering concept creates a dynamic weight transfer on the front wheels, maximising traction in all conditions.
- Class-leading handling on slopes, thanks to a combination of the steering concept, AWD and a low centre of gravity.
- Commercial-grade components for uncompromised durability and maximum uptime.
- Ergonomically designed operator interface with all controls within easy reach.
- Heavy-duty square tube ladder frame (4–10 mm) with an open design for easy service access.
- The Combi deck makes it easy to switch between mulching and rear discharge.
- The cutting deck can be tilted up without tools, for easy cleaning and maintenance.

The P 500 series high capacity commercial front mowers are designed for professional grounds maintenance over large expanses and areas with high complexity. Powerful and extremely versatile in a compact yet durable package with highly efficient cutting decks and a wide range of all year use attachments. The P 500 machines will help increase your daily turnover all year round, whether you prefer diesel, petrol or hybrid power.

Ideal for applications including:

- Professional grounds maintenance
- Large areas with complexity
- Parks and sports facilities
- Large residential
- Holiday parks
- All year round use

| Engine | Engine size / Power | Transmission | Cutting width |
|----------------------|------------------------------|-----------------|-------------------|
| Kawasaki EFI V-Twin | 726 cm ³ / 15.6kW | Hydrostatic AWD | 112 / 122 cm |
| Model | Order PNC | RRP ex VAT | RRP inc VAT |
| P 524Efi Unit | 967 84 81-01 | £11,665.83 | £13,999.00 |
| Combi 112 cm | 967 69 35-01 | £1,624.17 | £1,949.00 |
| Blade Kit (3 blades) | 504 18 78-10 | | |
| Combi 122 cm | 967 29 37-01 | £1,749.17 | £2,099.00 |
| Blade Kit (3 blades) | 535 42 94-10 | | |
| Unit + Combi 112 cm | Total RRP | £13,290.00 | £15,948.00 |
| Unit + Combi 122 cm | Total RRP | £13,415.00 | £16,098.00 |



COMBI 112 / 122



High performance compact Combi cutting decks offering two cutting methods: BioClip® and rear ejection. Market-leading mulching performance and super-efficient ejection. 112 cm & 122 cm cutting widths.

| Model | Order PNC | RRP ex VAT | RRP inc VAT |
|-----------|--------------|------------|------------------|
| Combi 112 | 967 69 35-01 | £1,624.17 | £1,949.00 |
| Combi 122 | 967 29 37-01 | £1,749.17 | £2,099.00 |

FLAIL MOWER



Robust, reliable flail mower for rough areas with overgrown grass and low brushwood. 100 cm working width, 5 working heights.

| Fitment | Order PNC | RRP ex VAT | RRP inc VAT |
|----------|--------------|------------|------------------|
| P 524EFi | 966 79 65-01 | £1,665.83 | £1,999.00 |

GRAVEL HARROW



Front-mounted attachment ideal for loosening compacted gravel surfaces and cutting of weed roots. Adjustable cutting depth. 125 cm working width.

| Fitment | Order PNC | RRP ex VAT | RRP inc VAT |
|----------|--------------|------------|------------------|
| P 524EFi | 587 93 20-01 | £1,415.83 | £1,699.00 |

BROOM



Rotating broom for sweeping up leaves, debris and light snow. Can be angled to either side. Adjustable working angle, working width 114 cm / 120 cm

| Fitment | Order PNC | RRP ex VAT | RRP inc VAT |
|----------|--------------|------------|------------------|
| P 524EFi | 966 79 63-01 | £1,749.17 | £2,099.00 |

RAKE



Rear-mounted rake to be used in combination with gravel harrow for levelling gravel and collecting weed. Lowered and lifted electrically from the seat.

| Fitment | Order PNC | RRP ex VAT | RRP inc VAT |
|----------|--------------|------------|------------------|
| P 524EFi | 587 93 25-01 | £957.50 | £1,149.00 |

SNOW BLADE



Snow blade for clearing paths and driveways. Can be set to different angles. Requires rubber strip 531 00 71-34. Working width 125 cm

| Fitment | Order PNC | RRP ex VAT | RRP inc VAT |
|----------|--------------|------------|------------------|
| P 524EFi | 966 83 30-01 | £957.50 | £1,149.00 |

FOLDING PLOUGH



Folding plough with mechanical blade adjustment, can be used as V-plough, point or diagonal plough. Equipped with rubber scraper blade. Working width 120 cm.

| Fitment | Order PNC | RRP ex VAT | RRP inc VAT |
|----------|--------------|------------|------------------|
| P 524EFi | 966 85 01-01 | £1,415.83 | £1,699.00 |

GRAMMER SEAT - P 524EFi



Deluxe seat with options for personal settings for optimum ergonomics. Available with or without heated seat. Armrests available as accessories.

| Fitment | Order PNC | RRP ex VAT | RRP inc VAT |
|----------|--------------|------------|------------------|
| P 524EFi | 966 95 42-01 | £915.83 | £1,099.00 |
| Heated | 966 95 42-02 | £999.17 | £1,199.00 |





P 520D



Highly productive large capacity diesel machine for long shifts in very large areas.

- Powerful 898 cm³ Kubota 3-cylinder diesel engine.
- Unique articulated steering concept creates a dynamic weight transfer on the front wheels, which maximises traction in all conditions.
- The steering concept in combination with AWD and a low centre of gravity provides excellent handling on slopes.
- Commercial-grade components means uncompromised durability and maximum uptime.
- Ergonomically designed operator interface with all controls within easy reach.
- Heavy-duty square tube ladder frame (4 – 10 mm) with an open design for easy service access.
- PTO Shaft for maximum efficiency and versatility.
- The Combi deck makes it easy to switch between mulching and rear discharge.

| Engine | Engine size / Power | Transmission | Cutting width |
|---------------------|------------------------------|-----------------|-------------------|
| Kubota D 902 diesel | 898 cm ³ / 14.7kW | Hydrostatic AWD | 132 cm |
| Model | Order PNC | RRP ex VAT | RRP inc VAT |
| P 520D Unit | 967 84 88-01 | £13,915.83 | £16,699.00 |
| Combi 132 | 967 97 83-01 | £2,665.83 | £3,199.00 |
| Combi 132X* | 967 97 85-01 | £3,332.50 | £3,999.00 |
| Unit + Combi 132 | Total RRP | £16,581.67 | £19,898.00 |
| Unit + Combi 132X* | Total RRP | £17,248.33 | £20,698.00 |

* Requires separate hydraulic kit accessory.

P 525DX

NEW
SPRING



Highly productive large capacity diesel machine for long shifts in very large areas.

- Powerful 1123 cm³ Kubota 3-cylinder diesel engine.
- Unique articulated steering concept creates a dynamic weight transfer on the front wheels, which maximises traction in all conditions.
- The steering concept in combination with AWD and a low centre of gravity provides excellent handling on slopes.
- Commercial-grade components means uncompromised durability and maximum uptime.
- Ergonomic driver interface with modern graphic display and easy-access to all controls.
- Built-in connectivity module allows connection to Husqvarna Fleet Services™.
- Heavy-duty square tube ladder frame (4 – 10 mm) with an open design for easy service access.
- PTO Shaft for maximum efficiency and versatility.
- The Combi deck makes it easy to switch between mulching and rear discharge.
- Extra wide tyres and high transport speed (18.5 km/h).
- Supplied with hydraulic kit.
- LED headlights

| Engine | Engine size / Power | Transmission | Cutting width |
|----------------------|-------------------------------|----------------------|-------------------|
| Kubota D 1105 diesel | 1123 cm ³ / 18.7kW | Fast Hydrostatic AWD | 132 / 155 cm |
| Model | Order PNC | RRP ex VAT | RRP inc VAT |
| P 525DX Unit | 967 98 53-01 | £17,082.50 | £20,499.00 |
| Combi 132 | 967 97 83-01 | £2,665.83 | £3,199.00 |
| Combi 132X | 967 97 85-01 | £3,332.50 | £3,999.00 |
| Combi 155 | 967 97 84-01 | £2,915.83 | £3,499.00 |
| Combi 155X | 967 97 86-01 | £3,582.50 | £4,299.00 |
| Unit + Combi 132X | Total RRP | £20,415.00 | £24,498.00 |
| Unit + Combi 155X | Total RRP | £20,665.00 | £24,798.00 |



P 525DX WITH CABIN

**NEW
SPRING**



Highly productive large capacity diesel machine fitted with cabin for long shifts and all year use in very large areas.

- Powerful 1123 cm³ Kubota 3-cylinder diesel engine.
- Unique articulated steering concept creates a dynamic weight transfer on the front wheels, which maximises traction in all conditions.
- The steering concept in combination with AWD and a low centre of gravity provides excellent handling on slopes.
- Commercial-grade components means uncompromised durability and maximum uptime.
- Ergonomic driver interface with modern graphic display and easy-access to all controls.
- Built-in connectivity module allows connection to Husqvarna Fleet Services™
- Heavy-duty square tube ladder frame (4 – 10 mm) with an open design for easy service access.
- PTO shaft for maximum efficiency and versatility.
- The Combi deck makes it easy to switch between mulching and rear discharge.
- Extra wide tyres and high transport speed (18.5 km/h)
- Spacious cabin with large glass front window with wiper, glass doors and Grammer seat.
- Vibration-isolated from the chassis, resulting in significantly lower noise and vibrations.
- Supplied factory fitted and equipped with hydraulic kit, LED light kits and counter weight. Cabin can be removed for summer use.

| Engine | Engine size / Power | Transmission | Cutting width |
|---------------------------|-------------------------------|----------------------|-------------------|
| Kubota D 1105 diesel | 1123 cm ³ / 18.7kW | Fast Hydrostatic AWD | 132 cm / 155 cm |
| Model | Order PNC | RRP ex VAT | RRP inc VAT |
| P 525DX with Cabin - Unit | 967 98 54-01 | £23,749.17 | £28,499.00 |
| Combi 132 | 967 97 83-01 | £2,665.83 | £3,199.00 |
| Combi 132X | 967 97 85-01 | £3,332.50 | £3,999.00 |
| Combi 155 | 967 97 84-01 | £2,915.83 | £3,499.00 |
| Combi 155X | 967 97 86-01 | £3,582.50 | £4,299.00 |
| Unit + Combi 132X | Total RRP | £27,081.67 | £32,498.00 |
| Unit + Combi 155X | Total RRP | £27,331.67 | £32,798.00 |

COMBI 132 / 155



Commercial Combi decks offering both BioClip® (mulching) and rear ejection. The decks have a low profile heavy duty box frame and replaceable side skid wears. The shell has been stamped from a single piece of 4.5 mm thick piece of metal to optimise airflow, resulting in cutting high efficiency. Both deck sizes feature manual height adjustment.

| Cutting width | Cutting heights | Height adjustment | Offset position |
|----------------------|-----------------|-------------------|------------------|
| 132 cm / 155 cm | 25 - 127 mm | Manual | Combi 155 only |
| Model | Order PNC | RRP ex VAT | RRP inc VAT |
| Combi 132 | 967 97 83-01 | £2,665.83 | £3,199.00 |
| Blade Kit (3 blades) | 586 19 88-10 | | |
| Combi 155 | 967 97 84-01 | £2,915.83 | £3,499.00 |
| Blade Kit (3 blades) | 586 19 89-10 | | |

COMBI 132X / 155X



Commercial Combi decks offering both BioClip® (mulching) and rear ejection. The decks have a low profile heavy duty box frame and replaceable side skid wears. The shell has been stamped from a single piece of 4.5 mm thick piece of metal to optimise airflow, resulting in cutting high efficiency. Both deck sizes feature hydraulic height adjustment, adjustable from the seat. Hydraulic kit required when used with P 520D.

| Cutting width | Cutting heights | Height adjustment | Offset position |
|----------------------|-----------------|-------------------|------------------|
| 132 cm / 155 cm | 25 - 127 mm | Hydraulic | Combi 155X only |
| Model | Order PNC | RRP ex VAT | RRP inc VAT |
| Combi 132X | 967 97 85-01 | £3,332.50 | £3,999.00 |
| Blade Kit (3 blades) | 586 19 88-10 | | |
| Combi 155X | 967 97 86-01 | £3,582.50 | £4,299.00 |
| Blade Kit (3 blades) | 586 19 89-10 | | |



P 535HX WITH HYBRID TECHNOLOGY. A NEW SMARTER WAY.

SMART GREEN SPACE MANAGEMENT

The most powerful front mower in the Husqvarna commercial range. Two electric motors power the wheel drive axles, while the PTO and electric generator are powered by a 1123 cm³ Kubota diesel engine. The 20" wheels, all-wheel drive and articulated steering make it easy to manoeuvre even in rough terrain and complex areas. Prepared for high capacity cutting decks up to 180 cm, providing an excellent result in any terrain. Commercial-grade components and ease of service make for uncompromised durability and maximum uptime.



LOWER EMISSIONS AND INCREASED OUTPUT

The incorporation of dual-energy sources combined with high efficiency in the Hybrid system enables high power output yet maintained in a compact and agile format. The power train reduces the vehicle's overall fuel consumption, CO₂ footprint and operational cost. Through an energy efficient electric drive vs normal hydrostatic drive, the energy efficiency in the machines propulsion system is improved by up to 50%. Hence depending on drive cycle, the fuel consumption is lowered by up to 30% when compared to a 19kW conventional diesel front mower working under the same conditions.

OPTIMISED PERFORMANCE WITH HYBRID POWER TRAIN

The P 535HX can be operated in two different drive modes. Electric mode is used during transportation vastly reducing emissions. Hybrid mode combines the diesel engine and battery buffer for maximum performance. Modes continuously adjust depending on cutting conditions. In normal conditions the power from the diesel engine is used to both operate the front attachment through the PTO, the propulsion and recharging of the batteries if needed. In demanding conditions, the power from the diesel engine is used to just operate the front attachment through the PTO. Power for propulsion is taken from the battery.





P 535HX

**NEW
SUMMER**

HYBRID



Powerful Hybrid commercial front mower. Two electric motors power the wheel drive axles, while the PTO and electric generator are powered by a 1123 cm³ Kubota diesel engine.

- Hybrid technology using a combination of powerful 1123cc Kubota 3- cylinder diesel engine, electric generator and electric drive motors.
- Hybrid energy storage system using 4.2 kWh Li-Ion 52 V batteries. Batteries are recharged when the PTO is engaged.
- Unique articulated steering concept creates a dynamic weight transfer on the front wheels, which maximises traction in all conditions.
- Electric All-Wheel Drive (AWD) with battery only quiet transport mode.
- The electric AWD propulsion system is electronically controlled via integrated sensors which ensures optimised traction. The drive wheels individually and automatically set the correct speed in all situations.
- The steering concept in combination with AWD and a low centre of gravity provides excellent handling on slopes.
- Commercial-grade components means uncompromised durability and maximum uptime.
- Ergonomic driver interface with intuitive hi-resolution touch colour screen and easy access to all controls.
- Built-in connectivity module allows connection to Husqvarna Fleet Services™.
- Heavy-duty square tube ladder frame (4 – 10 mm) with an open design for easy service access.
- Engine powered PTO shaft.
- Choice of cutting decks from 132 - 180cm. X variant Combi decks feature hydraulic height adjustment.
- Extra wide tyres and high transport speed (19.5 km/h)
- HVO100 ready. Hydrogenated Vegetable Oils (HVO) is a 100% synthetic diesel made from renewable materials.
- Supplied equipped with hydraulic kit.

| Engine | Engine size / Power | Transmission | Cutting width |
|----------------------|-------------------------------|--------------|-------------------|
| Kubota D 1105 diesel | 1123 cm ³ / 17.8kW | Electric AWD | 132 - 180 cm |
| Model | Order PNC | RRP ex VAT | RRP inc VAT |
| P 535HX Unit | 967 98 55-03 | £26,665.83 | £31,999.00 |
| Combi 132X | 967 97 85-01 | £3,332.50 | £3,999.00 |
| Combi 155X | 967 97 86-01 | £3,582.50 | £4,299.00 |
| R180 | 967 98 56-01 | £5,665.83 | £6,799.00 |
| Unit + Combi 132X | Total RRP | £29,998.33 | £35,998.00 |
| Unit + Combi 155X | Total RRP | £30,248.33 | £36,298.00 |
| Unit + R 180 | Total RRP | £32,331.67 | £38,798.00 |

COMBI 132X / 155X



Commercial Combi decks offering both BioClip® (mulching) and rear ejection. The decks have a low profile heavy duty box frame and replaceable side skid wears. The shell has been stamped from a single piece of 4.5 mm thick piece of metal to optimise airflow, resulting in cutting high efficiency. Both deck sizes feature hydraulic height adjustment, adjustable from the seat.

| Cutting width | Cutting heights | Height adjustment | Offset position |
|----------------------|-----------------|-------------------|------------------|
| 132 cm / 155 cm | 25 - 127 mm | Hydraulic | Combi 155X only |
| Model | Order PNC | RRP ex VAT | RRP inc VAT |
| Combi 132X | 967 97 85-01 | £3,332.50 | £3,999.00 |
| Blade Kit (3 blades) | 586 19 88-10 | | |
| Combi 155X | 967 97 86-01 | £3,582.50 | £4,299.00 |
| Blade Kit (3 blades) | 586 19 89-10 | | |

R180

**NEW
SUMMER**



Professional, high-capacity rear discharge cutting deck. The R180 is a heavy-duty 180 cm cutting deck with rear discharge, for use with Husqvarna P 535HX. Designed for the professional user seeking a wide, high-performance cutting deck for efficient mowing of large areas and long dense grass. Shaft driven with bevel gear. Requires counterweight.

| Cutting width | Cutting heights | Height adjustment | Offset position |
|----------------|-----------------|-------------------|------------------|
| 180 cm | 30 - 90 mm | Manual | N/A |
| Model | Order PNC | RRP ex VAT | RRP inc VAT |
| R180 | 967 98 56-01 | £5,665.83 | £6,799.00 |
| Blade (single) | 599 42 15-01 | | |



P 500 D / HX ACCESSORIES



A full range of attachments designed to increase the flexibility of your investment whilst allowing true all year round use. The range consists of PTO and hydraulic controlled front mount attachments all designed for full time commercial use and optimised for use with the P 500 Series.

WEED BRUSH



PTO driven rotating steel brush for removal of weeds and dirt on paths and curbstones. Angle adjustable from seat. Diameter 50 cm. Requires hydraulic kit (P 520D).

| Fitment | Order PNC | RRP ex VAT | RRP inc VAT |
|------------|--------------|------------|------------------|
| All models | 587 93 28-01 | £5,207.50 | £6,249.00 |

FLAIL MOWER



PTO driven flail mower with reinforced bevel gear. Excellent mulch performance in dense vegetation. Supplied with solid tyres. Working width 120 cm. Requires counterweight.

| Fitment | Order PNC | RRP ex VAT | RRP inc VAT |
|-----------------|--------------|------------|------------------|
| P 525DX / 535HX | 596 86 75-01 | £4,832.50 | £5,799.00 |

BROOM



PTO driven large diameter broom with adjustable working angle. Max/min working width 130/120 cm. Requires counterweight & hydraulic kit (P 520D).

| Fitment | Order PNC | RRP ex VAT | RRP inc VAT |
|------------|--------------|------------|------------------|
| All models | 596 45 00-01 | £4,165.83 | £4,999.00 |

UTILITY BUCKET



Hydraulic adjustment of angling and emptying. Working width 120 cm. Loading capacity 65 kg. Requires counterweight & hydraulic kit (P 520D).

| Fitment | Order PNC | RRP ex VAT | RRP inc VAT |
|------------|--------------|------------|------------------|
| All models | 965 99 74-01 | £1,249.17 | £1,499.00 |

BLOWER



PTO driven blower with powerful low noise fan capable of 80 m³/min air flow. 360 degree rotating air outlet adjustable from seat. Requires hydraulic kit (P 520D).

| Fitment | Order PNC | RRP ex VAT | RRP inc VAT |
|------------|--------------|------------|------------------|
| All models | 587 93 29-01 | £3,749.17 | £4,499.00 |





SPREADER



Electric spreader for gritting and de-icing on walkways. Stepless adjustable roller speed. The galvanised bucket holds 70 litres.

| Fitment | Order PNC | RRP ex VAT | RRP inc VAT |
|------------|--------------|------------|------------------|
| All models | 967 33 98-01 | £1,915.83 | £2,299.00 |

SNOW THROWER



Highly efficient and heavy-duty two-stage snow thrower. 120 cm working width, 68 cm intake height. Requires counterweight & hydraulic kit (P 520D).

| Fitment | Order PNC | RRP ex VAT | RRP inc VAT |
|------------|--------------|------------|------------------|
| All models | 590 45 19-01 | £5,415.83 | £6,499.00 |

FOLDING PLOUGH



Hydraulic adjustable blades. Reversible hardox steel wears with adjustable skid plates. Working width 140 cm to 119 cm. Requires counterweight & hydraulic kit (P 520D).

| Fitment | Order PNC | RRP ex VAT | RRP inc VAT |
|------------|--------------|------------|------------------|
| All models | 965 99 72-01 | £3,249.17 | £3,899.00 |

SNOW BLADE



Rugged steel snow blade. Hydraulic adjustment and 140 cm working width. Requires counterweight & hydraulic kit (P 520D). Requires support wheels and rubber scraper.

| Fitment | Order PNC | RRP ex VAT | RRP inc VAT |
|------------|--------------|------------|------------------|
| All models | 592 75 51-01 | £1,665.83 | £1,999.00 |

GRAMMER SEAT



Deluxe seat with options for personal settings for optimum ergonomics. Available with or without heated seat. Armrests available as accessories.

| Fitment | Order PNC | RRP ex VAT | RRP inc VAT |
|----------|--------------|------------|------------------|
| Standard | 967 00 84-01 | £1,082.50 | £1,299.00 |
| Heated | 967 00 84-02 | £1,249.17 | £1,499.00 |

HYDRAULIC KIT



Two auxiliary hydraulic connections to control front-mounted attachments. Includes valve, switch, hoses with connectors and wires.

| Fitment | Order PNC | RRP ex VAT | RRP inc VAT |
|---------------|--------------|------------|----------------|
| P 520D / 525D | 966 75 45-01 | £482.50 | £579.00 |

COUNTERWEIGHT



Rear counterweight for improved grip and stability. Must be used when operating front-mounted attachments. Total weight 62 kg.

| Fitment | Order PNC | RRP ex VAT | RRP inc VAT |
|------------|--------------|------------|----------------|
| All models | 966 75 49-01 | £482.50 | £579.00 |

! INCREASE YOUR PRODUCTIVITY WITH THE P 500 SERIES

For more information on the Husqvarna P 500 Series and to arrange a product demonstration please contact your local Authorised Husqvarna dealer.

Locate your nearest dealer
Visit: www.husqvarna.com/uk/dealer-locator

For complete accessories range and fitment guide please refer to page 146.



ATTACHMENT GUIDE

| MODEL ATTACHMENT | P 520D / P 525DX / P 535HX | | | | | | P 524EFI | | |
|---|----------------------------|-----------|------------------|---|---|---|--------------|----------|------------------|
| | ORDER PNC | EX VAT | INC VAT | P 520D | P 525DX | P 535HX | ORDER PNC | EX VAT | INC VAT |
| CUTTING DECK COMBI 112 | — | — | — | — | — | — | 967 69 35-01 | £1624.17 | £1,949.00 |
| CUTTING DECK COMBI 122 | — | — | — | — | — | — | 967 29 37-01 | £1749.17 | £2,099.00 |
| CUTTING DECK COMBI 132 | 967 97 83-01 | £2665.83 | £3,199.00 | ● | ● | ● | — | — | — |
| CUTTING DECK COMBI 155 | 967 97 84-01 | £2915.83 | £3,499.00 | — | ● | ● | — | — | — |
| CUTTING DECK COMBI 132X | 967 97 85-01 | £3,332.50 | £3,999.00 | C | ● | ● | — | — | — |
| CUTTING DECK COMBI 155X | 967 97 86-01 | £3582.50 | £4,299.00 | — | ● | ● | — | — | — |
| CUTTING DECK R180 | 967 98 56-01 | £5665.83 | £6,799.00 | — | — | A | — | — | — |
| GRAMMER PRIMO M SEAT | 967 00 84-01 | £1082.50 | £1,299.00 | ● | ● | S | 966 95 42-01 | £915.83 | £1,099.00 |
| GRAMMER PRIMO M SEAT, HEATED | 967 00 84-02 | £1,249.17 | £1,499.00 | ● | ● | ● | 966 95 42-02 | £999.17 | £1,199.00 |
| GRAMMER ARM REST KIT, RIGHT | 965 89 68-01 | £74.99 | £89.99 | ● | ● | S | 965 89 68-01 | £74.99 | £89.99 |
| GRAMMER ARM REST KIT, LEFT | 965 89 70-01 | £74.99 | £89.99 | ● | ● | S | 965 89 70-01 | £74.99 | £89.99 |
| RETRACTABLE SAFETY BELT FOR STANDARD SEAT | 576 78 34-01 | £45.83 | £54.99 | ● | ● | ● | — | — | — |
| CENTRAL GREASE KIT | 591 12 62-01 | £265.83 | £319.00 | ● | ● | ● | — | — | — |
| SNOW BLADE, STEEL | 592 75 51-01 | £1665.83 | £1,999.00 | A + C | A | A | 966 83 30-01 | £957.50 | £1,149.00 |
| RUBBER BLADE (Fits snow blade 966 83 30-01) | — | — | — | — | — | — | 531 00 71-34 | £49.99 | £59.99 |
| SNOW THROWER | 590 45 19-01 | £5415.83 | £6,499.00 | A + C | A | A | 966 79 64-01 | £1790.83 | £2,149.00 |
| UTILITY BUCKET | 965 99 74-01 | £1,249.17 | £1,499.00 | A + C | A | A | — | — | — |
| FLAIL MOWER | 596 86 75-01 | £4832.50 | £5,799.00 | — | A | A | 966 79 65-01 | £1665.83 | £1,999.00 |
| FOLDABLE PLOUGH | 965 99 72-01 | £3,249.17 | £3,899.00 | A + C | A | A | 966 85 01-01 | £1415.83 | £1,699.00 |
| BROOM | 590 45 00-01 | £4165.83 | £4,999.00 | A + C | A | A | 966 79 63-01 | £1749.17 | £2,099.00 |
| GRAVEL HARROW | — | — | — | — | — | — | 587 93 20-01 | £1415.83 | £1,699.00 |
| RAKE | — | — | — | — | — | — | 587 93 25-01 | £957.50 | £1,149.00 |
| BLOWER | 587 93 29-01 | £3749.17 | £4,499.00 | C | ● | ● | — | — | — |
| WEED BRUSH | 587 93 28-01 | £5207.50 | £6,249.00 | A + C | A | A | — | — | — |
| DROP SPREADER | 967 33 98-01 | £1915.83 | £2,299.00 | ● | ● | ● | — | — | — |
| TRAILER HOOK | 587 72 76-01 | £291.6 | £34.99 | ● | ● | ● | — | — | — |
| ROTATING BEACON LIGHT (ROPS) | 966 79 15-01 | £232.50 | £279.00 | ● | ● | ● | — | — | — |
| POSITION AND TURNING LIGHTS REAR, START KIT 1 | 966 79 09-01 | £374.17 | £449.00 | B | B | B | — | — | — |
| LOW SPEED VEHICLE TRIANGLE | 966 79 11-01 | £41.66 | £49.99 | 1 | 1 | 1 | — | — | — |
| POSITION AND TURNING LIGHTS FRONT | 966 79 10-01 | £182.50 | £219.00 | 1 | 1 | 1 | — | — | — |
| NUMBER PLATE KIT, ROPS | 966 79 13-01 | £45.83 | £54.99 | 1 | 1 | 1 | — | — | — |
| ATTACHMENT | | | | | | | | | |
| A COUNTERWEIGHT | 966 75 49-01 | £482.50 | £579.00 | ● | ● | ● | — | — | — |
| B CONTROL BOX | 966 79 08-01 | £499.17 | £599.00 | ● | ● | ● | — | — | — |
| C HYDRAULIC KIT | 966 75 45-01 | £482.50 | £579.00 | ● | S | S | — | — | — |

1 A = Requires additional attachments and/or parts.

● Suitable ○ Not recommended — Not applicable S - Comes as standard



TECHNICAL SPECIFICATIONS

| FRONT MOWERS | P 524EFI | P 520D | P 525DX / P 525DX WITH CABIN | P 535HX |
|--|----------------------------|----------------------------|---------------------------------------|---------------------------------------|
| TECHNICAL SPECIFICATIONS | | | | |
| Engine manufacturer | Kawasaki | Kubota™ | Kubota™ | Kubota™ |
| Engine name | FX Series V-Twin | D 902 | D1105 | D1105 |
| Net power at preset rpm, kW | 15.6 @ 3000 | 14.7 @ 3000 | 18.7 @ 3000 | 17.8 @ 3000 |
| Transmission type | Hydrostatic AWD | Hydrostatic AWD | Hydrostatic AWD | Electric AWD |
| Cylinder displacement, cm ³ | 726 | 898 | 1123 | 1123 |
| Cylinders | 2 | 3 | 3 | 3 |
| Sound power level, guaranteed (LWA), dB(A)* | 104 | 103 | 105 | 105 |
| Sound pressure level at operator's ear, dB(A)** | 88 | 88 | 92 | 88 |
| Vibration level steering wheel, m/s ² *** | 3 | 1.7 | 1.7 | 1.2 |
| Vibration level seat, m/s ² **** | 0.7 | 0.7 | 0.7 | 0.1 |
| Engine cooling | Air | Liquid | Liquid | Liquid |
| Generator, A | 20 | 40 | 40 | 40 (12V) and 80 (48V) |
| Battery, V/Ah | 12/24 | 12/62 | 12/62 | 12/62 (12V) and 52/40 (48V) |
| Air filter type | Heavy-duty canister style | Heavy-duty canister style | Heavy-duty canister style | Heavy-duty canister style |
| Fuel tank volume, litre | 22 | 25 | 25 | 23 |
| Oil tank volume (incl. oil filter), litre | 2.1 | 3.3 | 3.3 | 3.3 |
| Transmission manufacturer | Kanzaki | Kanzaki | Kanzaki | Benevelli |
| Transmission model | KTM 23 | KTM 23 | KTM 23 | TX2 |
| Speed forward, min – max, km/h | 0–13 | 0–15 | 0–18 | 0–19.5 |
| Speed reverse, min – max, km/h | 0–9 | 0–12 | 0–11 | 0–11 |
| Uncut circle, cm | 50 | 55 | 58 | 58 |
| Optional cutting decks | Combi 112 / 122 | Combi 132 / 132X | Combi 132 / 132X / 155 / 155X | Combi 132 / 132X / 155 / 155X / R 180 |
| Blade engagement | Electric clutch | Electric clutch | Electric clutch | Electric clutch |
| Frame construction type | Ladder frame | Ladder frame | Ladder frame | Ladder frame |
| Seat type | Premium | Full suspension | Full suspension | Full suspension |
| Tyre size front, inch | 18×8.5–8 | 18×8.5–8 | 20×10–10 | 20×10–10 |
| Tyre size rear, inch | 18×8.5–8 | 18×8.5–8 | 20×10–10 | 20×10–10 |
| Wheelbase, cm | 100 | 106 | 106 | 106 |
| Ground clearance, mm | 105 | 105 | 140 | 134 |
| Base machine length, cm | 205 | 207.5 | 211/227 | 209 |
| Base machine width, cm | 98 | 111 | 114/125.5 | 116 |
| Base machine height, cm | ROPS up 192, ROPS down 115 | ROPS up 200, ROPS down 130 | ROPS up 203, ROPS down 133, Cabin 201 | ROPS up 204, ROPS down 134 |
| Weight (excluding cutting deck), kg | 410 | 627 | 665/907 | 790 |
| FEATURES | | | | |
| Power steering | ● | ● | ● | ● |
| All-Wheel Drive (AWD) | ● | ● | ● | ● |
| Oil cooler | ● | ● | ● | ● |
| Hydraulic equipment lift | ● | ● | ● | ● |
| Service position | ● | ● | ● | ● |
| Hinged armrests | ● | ● | ● | ● |
| Digital hour meter | ● | ● | ● | ● |
| 12V outlet | ● | ● | ● | ● |
| ROPS | ● | ● | ●/– | ● |
| Integrated connectivity | – | ● | ● | ● |
| High contrast segment display | ● | ● | ● | – |
| Hydraulic attachment kit | – | – | ● | ● |
| Cup holder | ● | – | – | – |
| Dynamic graphic display | – | – | – | ● |
| Hybrid driveline | – | – | – | ● |

● = Available – = Not available * = Noise emissions in the environment measured and calculated as guaranteed sound power level according to EC-Directive 2000/14/EC. The guaranteed sound power level includes variation in production as well as variation from the test code with 1–2 dB(A). Noise emissions and sound pressure level can be influenced by the cutting deck used. Declared figures are for the machine equipped with the most used cutting unit for the specific mower model. For further information, see the Operator's manual. ** = Sound pressure level according to EN ISO 5395-1. Reported data for sound pressure level has a typical statistical dispersion (standard deviation) of 1.2 dB(A). *** = Vibration level according to EN ISO 5395-1. Reported data for vibration has a typical statistical dispersion of 0.2 m/s² (steering wheel) and 0.8 m/s² (seat).



A PERFECT MATCH FOR YOUR NEEDS

All our lawn mowers are designed to give the highest performance and efficiency with thoughtful ergonomic solutions. They have high-specification and easy-starting engines as well as durable cutting decks, delivering first class cutting results every time. So no matter what Husqvarna model you choose, you can expect a mower that's robust, reliable and one that delivers the results for healthy well kept green spaces.



WHAT YOU GET AND HOW WE DO IT



DURABLE ALUMINIUM CHASSIS

The chassis on all mowers is cast in one-piece aluminium, which gives optimal torsional rigidity and extends service life. Aluminium is a light material that doesn't rust, and it is solid enough for years of tough and demanding operation



BUILT FOR THE DEMANDS OF COMMERCIAL USE

Husqvarna professional mowers are fitted with commercial grade power units (petrol / battery) as well high specification commercial grade transmissions. Durable aluminium wheels with double ball bearings and connected to durable components ensure a long service life.



USE YOUR BACKPACK BATTERY, SAVE YOUR BACK

On our battery mowers using the backpack adaptor you can attach a backpack battery directly on top of the battery mower, instead of wearing a harness.



EXTRA CUTTING FORCE WHERE YOU NEED IT

The PowerBoost™ function increases the rpm of the cutting blades automatically when working in tough conditions, such as when mowing tall grass. This gives a "petrol-like" user experience.



VARIABLE SPEED





The variable speed function allows you to adjust the drive speed of the machine to suit your own walking speed. On our battery mowers the drive wheels are powered by a direct drive transmission with a dedicated, brushless electric motor. This means high productivity, energy efficiency and long service life.



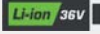

PRODUCT USE GUIDE

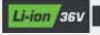
Use this guide to help you select the best product for your needs.



| TYPE OF USE | MODEL | POWER SOURCE | CUTTING WIDTH | PRODUCT TYPE | DRIVE SYSTEM | |
|--|-------------------------|--|---------------|--------------|-------------------------------|--|
|  PART-TIME USE (LANDOWNER / LANDSCAPER) | LB 442i |  Li-ion 36V | 42 cm | Wheeled | Push | |
| | LB 448i |  Li-ion 36V | 48cm | Wheeled | Push | |
| | LC 451S | Petrol | 51 cm | Wheeled | Self-propelled | |
|  FULL-TIME USE (PROFESSIONAL) | LC 551SP | Petrol | 51 cm | Wheeled | Self-propelled | |
| | LC 551iV |  Li-ion 36V | 51 cm | Wheeled | Variable speed self-propelled | |
| | LC 551VBP | Petrol | 51 cm | Wheeled | Variable speed self propelled | |
| | GX 560 | Petrol | 50.5 cm | Hover | Push | |
| | LB 548i |  Li-ion 36V | 48 cm | Wheeled | Push | |
| | KLIPPO LB 548S e | Petrol | 48 cm | Wheeled | Self-propelled | |
| | KLIPPO LB 553S e | Petrol | 53 cm | Wheeled | Self-propelled | |

The product selector is only to be used as a guide. Please visit your local Authorised Husqvarna dealer for more information.

* - Mulch kit is available as an accessory. ● Optimised solution (guideline only) ○ Capable solution but not optimal (guideline only)





| CUTTING SYSTEM | | | | RECOMMENDED LAWN AREA | | | | PAGE |
|----------------|------------|-------|---|---|--|---|-----|------|
| COLLECTION | REAR EJECT | MULCH |  |  |  |  | | |
| | | | SMALL | MEDIUM | LARGE | PROFESSIONAL GROUNDS MAINTENANCE | | |
| | | ● | ● | ● | | ○ | 154 | |
| | | ● | ● | ● | ○ | ○ | 154 | |
| ● | ● | ●* | | ● | ● | ○ | 152 | |
| ● | ● | ●* | | ● | ● | ● | 152 | |
| ● | ● | ●* | | ● | ● | ● | 153 | |
| ● | ● | ●* | | ● | ● | ● | 153 | |
| | | ● | ● | ● | | ● | 155 | |
| | | ● | ● | ● | ○ | ● | 154 | |
| | | ● | ● | ● | ○ | ● | 155 | |
| | | ● | | ● | ● | ● | 155 | |





COLLECTION LAWN MOWERS



Petrol and battery collection lawn mowers designed for part-time and full-time professional use on medium and larger areas in the most demanding conditions. Featuring commercial grade components and high specification engines or motors that deliver outstanding performance, durability and reliability no matter what the application. Additional 400 / 500 series features include highly durable cast aluminium cutting decks, cast aluminium rims (500 series) and commercial specification engines on the petrol powered models. For increased area capacity the battery version features dual battery slots which allows the use of any combination of one or two BLi batteries, with auto switch. For maximum area coverage the backpack battery can also be used when fitted to machine mounted carrier accessory.

Ideal for applications including:

- Municipality
- Grounds maintenance
- Parks and public spaces
- Sports fields

LC 451S



Durable semi-professional self-propelled petrol lawnmower designed for part-time use. Aluminium deck and excellent collection performance.

- Collect / BioClip® / rear eject
- Adjustable, folding handles
- 65 litre canvas collector
- Cast aluminium deck
- Central height adjustment
- Vibration level 4.0 m/s²

| Engine | Cutting Width | Cutting Height | Drive |
|------------------------------|---------------|----------------|----------------|
| B&S 750e 161 cm ³ | 51 cm | 26 - 74 mm | Single speed |
| Weight | Order PNC | RRP ex VAT | RRP inc VAT |
| 406 kg | 967 34 31-02 | £732.50 | £879.00 |

LC 551SP



High performance fully professional self-propelled petrol lawnmower designed for full-time use. Aluminium deck and excellent collection performance.

- Collect / BioClip® / rear eject
- Adjustable, folding handles
- 65 litre canvas collector
- Cast aluminium deck / wheels
- Central height adjustment
- Vibration level 4.5 m/s²

| Engine | Cutting Width | Cutting Height | Drive |
|-------------------|---------------|----------------|----------------|
| Kawasaki FJ180KAI | 51 cm | 26 - 74 mm | Single speed |
| Weight | Order PNC | RRP ex VAT | RRP inc VAT |
| 500 kg | 967 34 32-02 | £832.50 | £999.00 |



LC 551iV



Li-ion 36V



High performance fully professional self-propelled battery lawnmower designed for full-time use. Digital control, user interface and Fleet Services™ compatible.

- Collect / BioClip® / rear eject
- Adjustable, folding handles
- 65 litre canvas collector
- Cast aluminium deck / wheels
- Integrated or backpack battery
- Vibration level 0.3 m/s²

| Voltage | Cutting Width | Cutting Height | Drive |
|-------------------------------------|---------------|----------------|------------------|
| 36V Li-ion | 51 cm | 26 - 74 mm | Variable speed |
| Model | Order PNC | RRP ex VAT | RRP inc VAT |
| LC 551iV Unit only | 967 97 72-01 | £1,040.83 | £1,249.00 |
| Unit + BLi300 & QC500 (recommended) | | £1,406.66 | £1,687.99 |

WORKING TIME ON ONE CHARGE

LC 551iV



| | | |
|--|----------------|------------|
| | BLi200 | 15 min |
| | BLi300 | 30 min |
| | BLi550X | 50 min |
| | BLi950X | 1 h 35 min |

Working time shown is with a single battery.

LC 551VBP



High performance fully professional variable speed self-propelled petrol lawnmower designed for full-time use. Blade brake clutch and aluminium deck.

- Collect / BioClip® / rear eject
- Blade brake clutch
- 65 litre canvas collector
- Cast aluminium deck / wheels
- Adjustable, folding handles
- Vibration level 4.5 m/s²

| Engine | Cutting Width | Cutting Height | Drive |
|-------------------|---------------|----------------|------------------|
| Kawasaki FJ180KAI | 51 cm | 26 - 74 mm | Variable speed |
| Weight | Order PNC | RRP ex VAT | RRP inc VAT |
| 530 kg | 967 09 96-02 | £1,082.50 | £1,299.00 |

MULCH KITS

| Model | LC 451S / 551SP | LC 551iV | LC 551VBP |
|------------|-----------------|---------------|---------------|
| Blade size | 51 cm | 51 cm | 51 cm |
| PNC | 589 21 49-01 | 597 41 37-01 | 589 81 75-01 |
| Ex VAT | £31.66 | £33.33 | £31.66 |
| Inc VAT | £37.99 | £39.99 | £37.99 |

REPLACEMENT BLADES

| Model | LC 451S / 551SP | LC 551iV | LC 551VBP |
|------------|-----------------|--------------|--------------|
| Blade type | Collection | | |
| PNC | 587 59 08-10 | 587 59 08-10 | 597 46 63-10 |
| Blade type | Mulch | | |
| PNC | 504 11 33-20 | 502 88 13-10 | 295 67 32-20 |



Locate your nearest dealer

Visit: www.husqvarna.com/uk/dealer-locator

HUSQVARNA RECOMMEND

4-stroke fuel, oil and lubricants optimised for your Husqvarna lawn mower. Pages 180 - 181



DID YOU KNOW?

The BLi carrier attachment allows the BLi backpack batteries to power the LC 551iV for extended runtime.



| Model | Order PNC | RRP ex VAT | RRP inc VAT |
|----------------------|--------------|------------|---------------|
| BLi Backpack Carrier | 597 84 87-01 | £37.49 | £44.99 |



MULCH LAWN MOWERS



Petrol and battery mulch lawn mowers designed for part-time and full-time professional use on medium and larger areas in the most demanding conditions. Featuring commercial grade components and high specification engines or motors that deliver outstanding performance, durability and reliability no matter what the application. 400 / 500 series features include highly durable cast aluminium cutting decks and commercial specification engines on the petrol powered models. For increased area capacity the battery versions features dual battery slots which allows the use of any combination of one or two BLi batteries, with auto switch. For maximum area coverage the backpack battery can also be used when fitted to machine mounted carrier accessory (LB 548i).

Ideal for applications including:

- **Municipality**
- **Grounds maintenance**
- **Parks and public spaces**
- **Sports fields**

LB 442i

NEW
SPRING

Li-ion 36V



Compact battery mulch mower designed for semi-professional use, ideal in complex smaller areas. Features user interface with PowerBoost and savE™ modes. Fleet Services™ compatible.

- BioClip® (mulch)
- Adjustable handle
- 2 integrated battery slots
- Cast aluminium deck
- Central height adjustment
- Vibration level 0.3 m/s²

| Voltage | Cutting Width | Cutting Height | Drive |
|-------------------------------------|---------------|----------------|----------------|
| 36V Li-ion | 42 cm | 34 - 55 mm | Push |
| Model | Order PNC | RRP ex VAT | RRP inc VAT |
| LB 442i Unit only | 970 48 23-01 | £457.50 | £549.00 |
| Unit + BLi300 & QC500 (recommended) | | £832.33 | £987.99 |

LB 448i

NEW
SPRING

Li-ion 36V



Battery mulch mower designed for semi-professional use, ideal in complex areas. Features user interface with PowerBoost and savE™ modes. Fleet Services™ compatible.

- BioClip® (mulch)
- Adjustable handle
- 2 integrated battery slots
- Cast aluminium deck
- Central height adjustment
- Vibration level 0.3 m/s²

| Voltage | Cutting Width | Cutting Height | Drive |
|-------------------------------------|---------------|----------------|------------------|
| 36V Li-ion | 48 cm | 30 - 60 mm | Push |
| Model | Order PNC | RRP ex VAT | RRP inc VAT |
| LB 448i Unit only | 970 48 24-01 | £624.17 | £749.00 |
| Unit + BLi300 & QC500 (recommended) | | £989.99 | £1,187.99 |

LB 548i

Li-ion 36V



High capacity mulch mower designed for professional use, ideal in complex areas. Features user interface with PowerBoost and savE™ modes. Fleet Services™ compatible.

- BioClip® (mulch)
- Adjustable handle
- Integrated x2 or backpack battery
- Cast aluminium deck / wheels
- Central height adjustment
- Vibration level 0.3 m/s²

| Voltage | Cutting Width | Cutting Height | Drive |
|-------------------------------------|---------------|----------------|------------------|
| 36V Li-ion | 48 cm | 30 - 60 mm | Push |
| Model | Order PNC | RRP ex VAT | RRP inc VAT |
| LB 548i Unit only | 967 97 73-01 | £790.83 | £949.00 |
| Unit + BLi300 & QC500 (recommended) | | £1156.66 | £1,387.99 |



KLIPPO LB 548S e



Compact mulch mower designed for professional use, ideal in complex and confined areas. Side adjustable handlebar for optimal flexibility and highly durable cutting deck.

- BioClip® (mulch)
- Adjustable handle
- Front wheel drive
- Cast aluminium deck / wheels
- Central height adjustment
- Vibration level 4.8 m/s²

| Engine | Cutting Width | Cutting Height | Drive |
|----------------|---------------|----------------|----------------|
| Honda GCVX-170 | 48 cm | 30 - 60 mm | Single speed |
| Weight | Order PNC | RRP ex VAT | RRP inc VAT |
| 32.5 kg | 970 48 21-01 | £790.83 | £949.00 |

KLIPPO LB 553S e



Large capacity mulch mower designed for professional applications, ideal for use in larger areas. Side adjustable handlebar for optimal flexibility and highly durable cutting deck.

- BioClip® (mulch)
- Adjustable handle
- Front wheel drive
- Cast aluminium deck / wheels
- Central height adjustment
- Vibration level 4.1 m/s²

| Engine | Cutting Width | Cutting Height | Drive |
|----------------|---------------|----------------|------------------|
| Honda GCVX-170 | 53 cm | 27 - 65 mm | Single speed |
| Weight | Order PNC | RRP ex VAT | RRP inc VAT |
| 36.7 kg | 970 48 22-01 | £874.17 | £1,049.00 |

GX 560



Petrol hover mower designed for professional use. Uses air cushion mowing, ideal in applications that feature difficult ground conditions and slopes up to 45 degrees.

- ABS Deck
- 45° maximum working angle
- Vibration level 3.3 m/s²
- Folding handles
- Mow in any direction

| Engine | Cutting Width | Cutting Height | Drive |
|--------------|---------------|----------------|----------------|
| Honda GCV160 | 50.5 cm | 10 - 30 mm | Push |
| Weight | Order PNC | RRP ex VAT | RRP inc VAT |
| 18.2 kg | 964 00 06-02 | £582.50 | £699.00 |

WORKING TIME

Li-ion 36V

| | LB 442i | LB 448i | LB 548i |
|--|---------|---------|---------|
|--|---------|---------|---------|



| | | | | |
|--|----------------|--------|--------|------------|
| | BLi200 | 35 min | 25 min | 25 min |
| | BLi300 | 55 min | 45 min | 45 min |
| | BLi550X | – | – | 1 h 15 min |
| | BLi950X | – | – | 2 h 20 min |

Working time shown is with a single battery.

REPLACEMENT BLADES

| Model | LB 442i | LB 448i |
|------------|--------------|--------------|
| Blade type | Mulch | |
| PNC | 599 70 71-10 | 597 46 65-10 |

| Model | LB 548i | LB 548S e | LB 553S e |
|------------|--------------|--------------|--------------|
| Blade type | Mulch | | |
| PNC | 597 46 65-10 | 502 88 13-10 | 295 67 32-20 |

| Model | GX560 |
|------------|--------------|
| Blade type | Mulch |
| PNC | 511 90 04-00 |



Locate your nearest dealer

Visit: www.husqvarna.com/uk/dealer-locator

DID YOU KNOW?

The BLi carrier attachment allows the BLi backpack batteries to power the LB 548i for extended runtime.



| Model | Order PNC | RRP ex VAT | RRP inc VAT |
|----------------------|--------------|------------|---------------|
| BLi Backpack Carrier | 597 84 87-01 | £37.49 | £44.99 |



TECHNICAL SPECIFICATIONS

| | LC 451S | LC 551SP | LC 551VBP | KLIPPO LB 548S e | KLIPPO LB 553S e | GX 560 |
|-----------------------------------|---------------------------------------|---------------------------------------|---------------------------------------|------------------------------|------------------------------|-------------------|
| TECHNICAL SPECIFICATIONS | | | | | | |
| Engine manufacturer | Briggs & Stratton | Kawasaki | Kawasaki | Honda | Honda | Honda |
| Engine name | 750e DOV | FJ180KAI | FJ180KAI | GCVX-170 | GCVX-170 | GCV160 |
| Net power at preset rpm, kW | 2.6 @ 2900 | 2.9 @ 2800 | 2.9 @ 2800 | 3.3 @ 2900 | 3.3 @ 2900 | 3.0 @ 3150 |
| Fuel tank volume, litres | 1.0 | 1.9 | 1.9 | 0.9 | 0.9 | 0.9 |
| Drive system | Self-propelled, single speed | Self-propelled, single speed | Self-propelled, single speed | Self-propelled, single speed | Self-propelled, single speed | Push, hover model |
| Drive wheels | Rear | Rear | Rear | Front | Front | — |
| Rims, material | Plastic | Aluminium | Aluminium | Aluminium | Aluminium | — |
| Wheel size, front/rear, mm | 210/210 | 210/210 | 210/210 | 203/203 | 203/203 | — |
| Speed, km/h | 4.1 | 4.1 | 5.0 | 5.0 | 4.8 | — |
| Cutting deck material | Aluminium | Aluminium | Aluminium | Aluminium | Aluminium | ABS plastic |
| Cutting methods | Collection / BioClip® / Rear ejection | Collection / BioClip® / Rear ejection | Collection / BioClip® / Rear ejection | BioClip® | BioClip® | — |
| Cutting width, cm | 51.0 | 51.0 | 51.0 | 48.0 | 53.0 | 50.5 |
| Cutting height, min-max, mm | 26-74 | 26-74 | 26-74 | 30-60 | 27-65 | 10-30 |
| Cutting height steps | 6 | 6 | 6 | 6 | 5 | 3 |
| Blade type | Collect | Collect | Collect | Mulch | Mulch | — |
| Collector type | Fabric with dust blocker | Fabric with dust blocker | Fabric with dust blocker | — | — | — |
| Collector volume, litres | 65 | 65 | 65 | — | — | — |
| Handle type | Ergonomic | Ergonomic | Ergonomic | Anti-vibrated | Anti-vibrated | Comfort |
| Weight, kg | 40.6 | 50.0 | 53.0 | 32.5 | 36.7 | 18.2 |
| FEATURES | | | | | | |
| Anti-vibrated handle | — | — | — | ● | ● | — |
| Blade brake clutch | — | — | ● | — | — | — |
| Central cutting height adjustment | ● | ● | ● | ● | ● | — |
| Double ball-bearing wheels | ● | ● | ● | ● | ● | — |
| Foldable handle | ● | ● | ● | — | — | ● |
| Handle height adjustment | ● | ● | ● | ● | ● | — |
| ReadyStart™ | — | — | ● | — | — | — |
| Side adjustable handle | — | — | — | ● | ● | — |

● = Available (●) = Accessory — = Not available

! ALWAYS USE GENUINE HUSQVARNA LUBRICANTS AND SPARE PARTS FOR YOUR LAWN MOWER

These high quality spare parts and lubricants are developed to facilitate the care and maintenance of your Husqvarna equipment and enable trouble-free operation and storage. We also supply the most frequent service parts for our products. See your owner's manual or consult your Authorised Husqvarna dealer if any uncertainty occurs.

IMPORTANT! Check the oil/lubricant levels before each work shift and top up.

Recommended frequently used parts for lawn mowers:

- Mulch blades
- Standard blades
- Collect blades.
- Engine oil 10 W/30
- Spark plugs
- Air filters and oil filters

Always read your owner's manual or contact your dealer for recommended parts for your machine.

NOMINAL POWER A new machinery directive (2006/42/EC) came into force on January 1, 2010, requiring manufacturers to declare the nominal power of engines, in kilowatts (kW). The power rating of the engines indicated is the average net power output during a normal working situations and meets applicable noise regulations (at specified rpm, see owner manual) of a typical production engine for the engine model measured to SAE standard J 1349/ISO 1585. Mass production engines may differ from this value. Actual power output for the engine installed in the final machine will depend on the operating speed, environmental conditions and other variables.





AN EASIER WAY TO KEEP TRACK OF YOUR EQUIPMENT

Just put a sensor on any piece of equipment and you'll always know where your machines are, how much they've been used, when they need to be serviced or replaced – and much more. If you use our professional robotic mowers, you don't even need to install a sensor. All this updated information – easily accessible from your phone, tablet or laptop – allows you to save a lot of time and money, to develop your business even further.

HOW IT WORKS

The system keeps track of your equipment either through the use of machine sensors or – in the case of our professional robotic mowers – built-in connectivity. The equipment data is transmitted via Bluetooth (for Automower® it's via 2G/3G) and can either be collected in the field via the intuitive Husqvarna Fleet Services™ app, or back in storage via the Husqvarna Fleet Services™ Gateway app. The combination of these apps gives you updated data that's automatically uploaded to the cloud-based account where you can access it from any device if you decide not to continue with the service.

Read more at www.husqvarna.com/uk/fleetservices



REDUCE YOUR CO₂ EMISSIONS

Whether you work for a council or a commercial contractor, reducing CO₂ emissions is an important target. The Carbon Footprint Calculator provides you with the data and insights you need to take action – and of course, to report your progress to your stakeholders.



COMPLETE FLEET MANAGEMENT, HOW IT MAKES YOUR WORKDAY EASIER

The system keeps track of your equipment through the use of machine sensors. The equipment data is transmitted via Bluetooth and can either be collected in the field via the intuitive Husqvarna Fleet Services™ app, or back in storage via the Husqvarna Fleet Services™ Gateway app. The combination of these apps gives you updated data that's automatically uploaded to the cloud-based account where you can access it from any device

ALL YOUR EQUIPMENT IN ONE PLACE

Don't rely on paperwork. With Husqvarna Fleet Services™, you just check the inventory list, and you know exactly how many machines you have of each type. Give them unique names, and you can easily tell which is which. You can add sensors to all sorts of equipment, even machines from other manufacturers. By using tags, different machines can be categorised for different purposes. This could include "tagging" machines for different locations or to different teams.

SERVICE HISTORY AND NOTIFICATIONS

By using Husqvarna Fleet Services™, you always have access to the service history for each piece of equipment, making it much easier to keep track of its status and troubleshoot in case of a breakdown. You can also get service reminders based on actual engine hours or calendar time, to make sure your equipment is always in great shape.

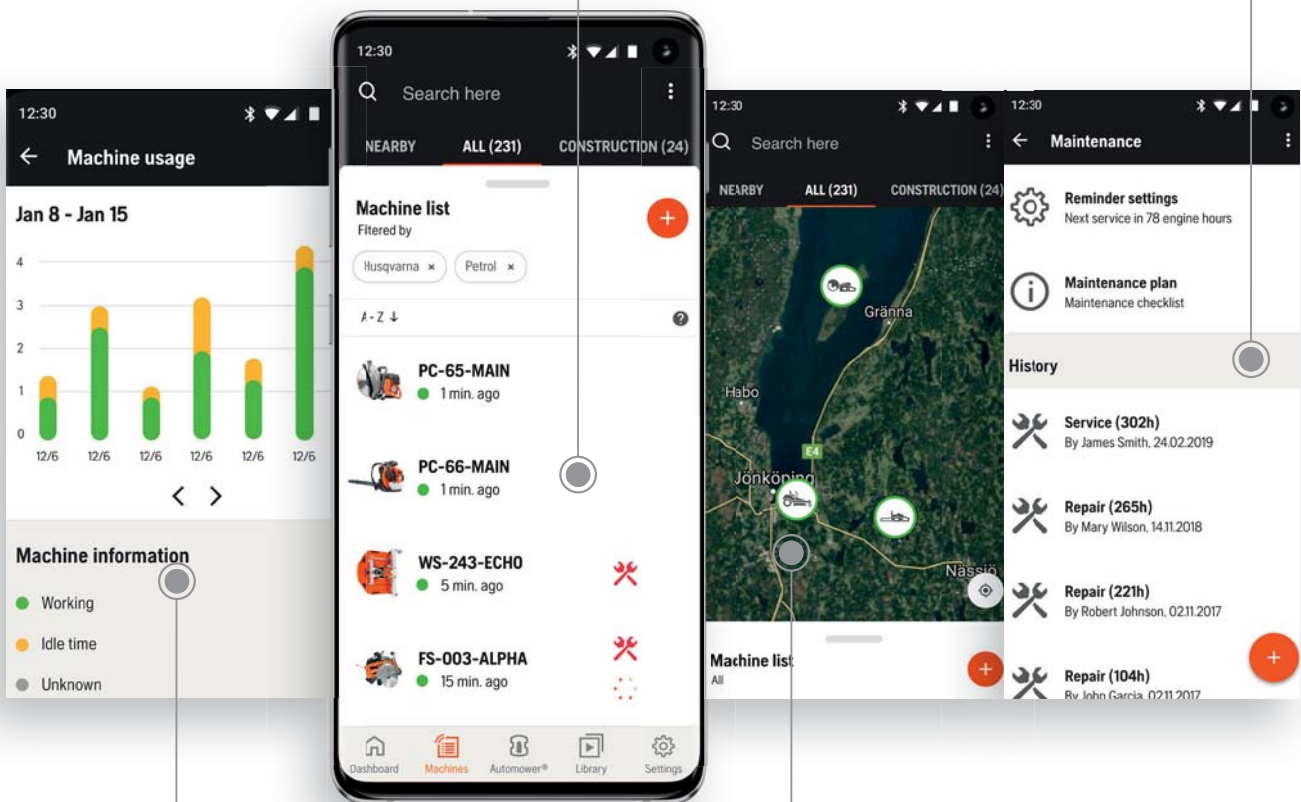

SEE WHEN AND HOW MUCH YOU'VE USED IT

Since the sensors track the engine hours of every machine, you can easily get an overview with Husqvarna Fleet Services™. You can produce a workday log with detailed information on how many hours they have been used every day.

TRACK THEM ALL ON THE MAP

Always keep track of where you last had your equipment. As soon as a machine with a sensor is within Bluetooth® distance from the app, its location is registered. So whenever you're looking for a machine, you just check the map to find out if it's in the storage, away for service or out working. The tag feature makes it possible to have grouped machines performing specific tasks within specific pre-set geographic locations.





+ INTEGRATED CONNECTIVITY

Selected 500 series battery and ride on machines feature a built-in connectivity module allowing easy connection to Husqvarna Fleet Services™. This allows you to see each machine's last known location, its usage statistics and service history – and much more without the need of a machine sensor. This also facilitates updates of the machine's firmware, so that it's always compatible with the latest functions in Husqvarna Fleet Services™.

All 500 Series robotic mowers are supplied as standard with Husqvarna Fleet Services™. With a free 10 year data plan included it gives you the possibility to monitor and control multiple numbers of mowers from your smart phone, tablet or laptop. You can overview your mower's status or exact location and adjust various settings. The digital tool also sends notifications and allows you to track the mower's position in case of theft – from anywhere.

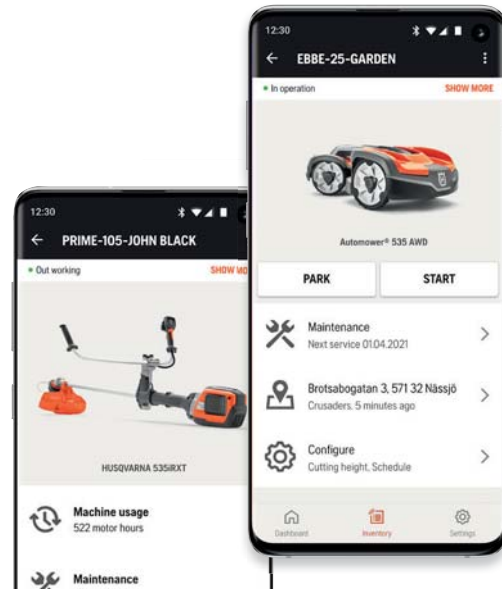

SUBSCRIPTION PLANS

Try Husqvarna Fleet Services™ and find out how it can improve your business. It's easy to get started. Select the plan that best suits the requirements of your business. The system is scalable allowing full integration no matter how small or large your fleet size.



MACHINE SENSOR



The machine sensor allows you to connect all sorts of hand held and wheeled machines. This also includes products from other manufacturers.

| Fits to | Order PNC | RRP ex VAT | RRP inc VAT |
|---------|--------------|------------|---------------|
| Machine | 584 91 89-05 | £14.00 | £16.80 |

MACHINE SENSOR KEY



Specialist tool designed for opening and closing the machine sensor, for instance to change the battery.

| Fits to | Order PNC | RRP ex VAT | RRP inc VAT |
|----------------|--------------|------------|--------------|
| Machine sensor | 585 47 76-01 | £2.25 | £2.70 |

FIND OUT MORE POSSIBILITIES

For more information on Husqvarna Fleet Services™ and detailed subscription plans based upon the requirements of your business.

Visit www.husqvarna.com/uk/fleetservices

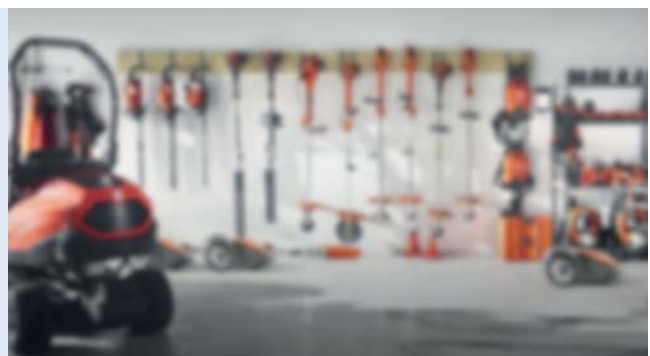



THE PROFESSIONAL WAY TO MANAGE YOUR ROBOTIC MOWERS

When you invest in our 500 Series robotic mowers, you get free access to Husqvarna Fleet Services™ – a digital tool allowing you to easily monitor and control them from your smart phone, tablet or laptop. Just as easy as it should be.

FILTERS THAT MAKE YOUR MOWERS MORE EFFICIENT

Different mowers can be “tagged” to different teams, or to different locations, and then grouped for easier handling. The different user roles can also be tagged with different levels of control.

ALWAYS KEEP TRACK OF THEIR EXACT LOCATIONS

Want an overview of all your robotic mowers? Just check the map view. Thanks to the built-in GPS, you always know the exact location and status of every robotic mower. Use tags to issue commands to all mowers in specific areas for even easier fleet handling.

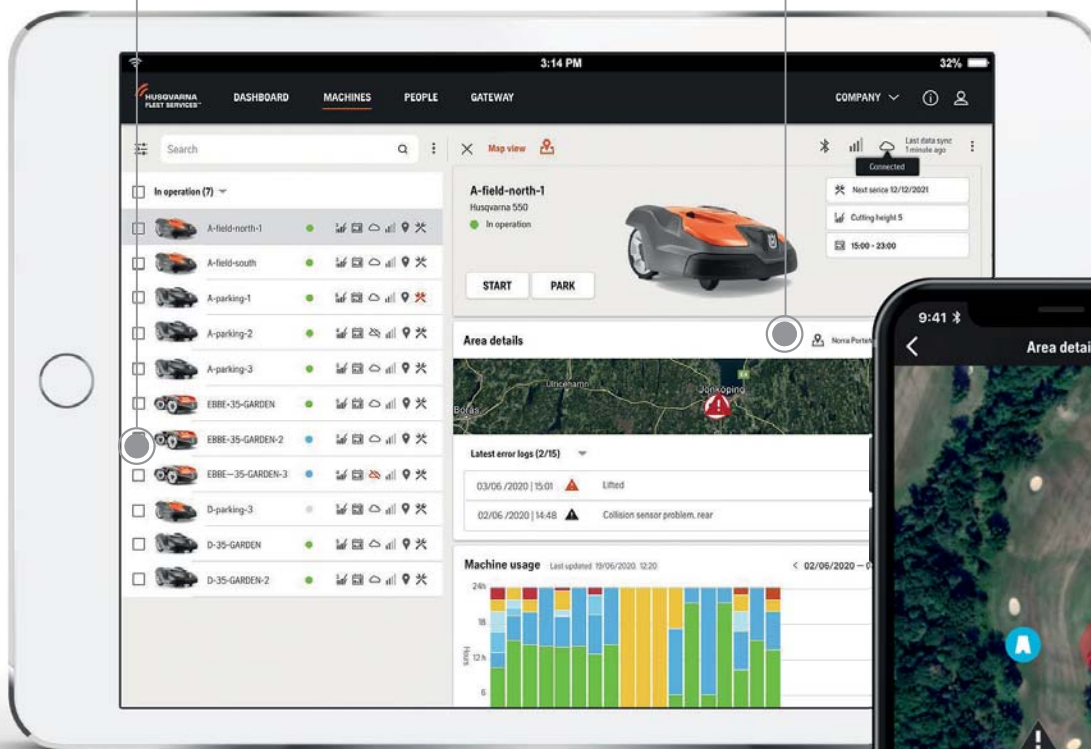

**FREE
10 YEAR
DATA PLAN
INCLUDED**

FULL CONTROL AND SCHEDULING FROM ANYWHERE

Forget manual controls. With Husqvarna Fleet Services™, you – and only you – conveniently control your robotic mowers from anywhere. Perfect when you want to adjust the mowing schedule or cutting height, or park them before the storm arrives. And thanks to tagging, you can exert exact control over all your mowers, grouping them and issuing batch commands, directly from your smartphone app.

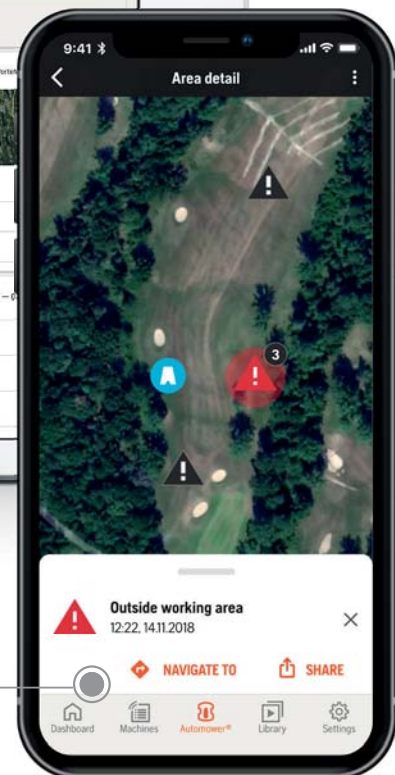

OPERATIONAL INSIGHTS

Should anything happen, such as an unexpected standstill for one mower, you'll immediately receive a notification to your phone. Information about where problems occur and how often give you valuable insights to continuously adjust and improve the installation, which ensure a smooth and efficient operation. Through the Automower® Machine usage tab, you can review daily user data for more insights. The information is summarised in an easy and accessible way, helping you make your fleet usage more efficient and productive.

+ ALL YOUR EQUIPMENT IN ONE PLACE

If you want to, you can also connect the rest of your equipment to the system by using Husqvarna Fleet Services™ sensors. [Learn more at www.husqvarna.com/uk/fleetservices](http://www.husqvarna.com/uk/fleetservices)





DO THE DAILY CHECKS YOURSELF, LEAVE THE REST TO OUR EXPERTS

With over 300 Authorised Husqvarna dealers in the UK, you're never far from professional service and support using only Genuine Husqvarna spare parts, fuels and lubricants. Our dealers are the experts in keeping your machines running safe, smooth and strong.

For more information visit www.husqvarna.com/uk/support



GET SERVICE NOTIFICATIONS FROM YOUR CONNECTED HUSQVARNA PRODUCTS

With the Husqvarna Connect app, you can get notifications to your smartphone when your connected products need a service. You can find the nearest Authorised Husqvarna dealer, make the call and even bookmark your favourite dealer directly in the app.

For more details visit www.husqvarna.com/uk

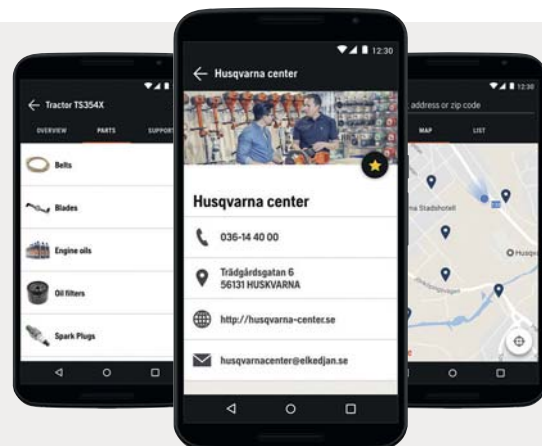



PROFESSIONAL SUPPORT FOR PROFESSIONAL DEMANDS

Your Authorised Husqvarna dealer can advise you on machinery and services to suit your needs. They can also supply you with Genuine Husqvarna spare parts, lubricants and accessories as well as adequate service and repair to keep your Husqvarna equipment ready for your next job. Our dedicated dealers provide professional services for your machines, to safeguard optimal performance and reliability. The Authorised Husqvarna dealer network consists of 25,000 locations worldwide, so we're never far away. See our interactive dealer locator on www.husqvarna.com/uk/dealer-locator.

KEEP YOUR MACHINES IN ORIGINAL SHAPE WITH GENUINE HUSQVARNA SPARE PARTS

Our product development always starts with you, the user, in focus, to make your work less strenuous and more efficient. This is also why every single part in a Husqvarna machine is rigorously tested to ensure it interacts optimally with all the other parts. This interaction produces the reliability and characteristics you have the right to expect from a Husqvarna, while proper servicing and using the right parts mean your equipment performs safely, reliably and economically in the long run. Genuine Husqvarna spare parts allow you to get the most out of your Husqvarna.



ENJOY OUR OFF-SEASON SERVICE OFFERS

It's wise to let your Authorised Husqvarna dealer do the service in the off-season period when your garden rests from growing and you can spare your equipment for a while. Look out for the off-season service offers and local pick-up /delivery services offered by your Authorised Husqvarna dealer. Don't forget to ask your dealer to register your product at your dealership to ensure special offers and information.

MINIMISE YOUR DOWNTIME WITH PREVENTIVE MAINTENANCE AND REPAIR

At our dealers, all servicing is done by authorised technicians. They are all specialists trained in the machines you are using. Many workshops have fixed prices for all forms of service - look out for our Service Menus at your local dealer. For each machine there is a detailed service plan, which is divided into a number of time intervals and presented to you in our Service Checklists. By maintaining your machines regularly and servicing them at the recommended times, you ensure the machines are performing optimally. You also minimise the risk of unexpected downtime. And, just as importantly, the machine will last longer.



+ ADD PERFORMANCE WITH HUSQVARNA ACCESSORIES



Why let poor equipment get in your way? Husqvarna accessories allow you to keep working – and delivering great results. By choosing Husqvarna accessories and lubricants from our extensive product range, you are guaranteed the same high quality throughout the lifespan of the product.

+ HUSQVARNA WARRANTY

Consumer Use - Products and Accessories. Husqvarna provides a 24 month warranty for consumer use provided that the following conditions are met: Sale of Husqvarna products must be registered through intended applications in the Husqvarna Reseller Portal, or to its connected services. The Husqvarna Product must have a proven service history in accordance with the product operator handbook/manual (where service instructions are provided).

Professional Use - Products and Accessories. Husqvarna provides a 12 month warranty for professional use provided that the following conditions are met: Sale of Husqvarna products must be registered through intended applications in the Husqvarna Reseller Portal, or to its connected services. The Husqvarna Product must have a proven service history in accordance with the product operator handbook/manual (where service instructions are provided).

Note! Battery warranty is handled separately, see your Husqvarna dealer for details.





EXPECT MAXIMUM PROTECTION – NO MATTER THE PERFORMANCE LEVEL

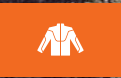

LAYERED PROTECTION

Our advanced protective material comprises fewer layers. This makes it lighter, without compromising protection levels. The material and layering design consists of long fibres that can become tangled in the chain.



CONFIDENT SAFETY WITH REGULAR TESTING

Protective clothing for forestry work must carry CE marking. The additional EuroTest mark shows that randomly selected samples are regularly re-inspected by an accredited institute.



Good protective equipment must withstand demanding conditions and provide the required protection. That's why we use nothing but high-quality materials. Each job comes with different requirements. Our range of protective clothing takes into consideration every type of work.

In fact, our extensive range of safety clothing, offering the latest innovations in design and materials, will provide you with the level of protection and comfort you need to get the job done.

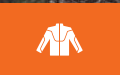
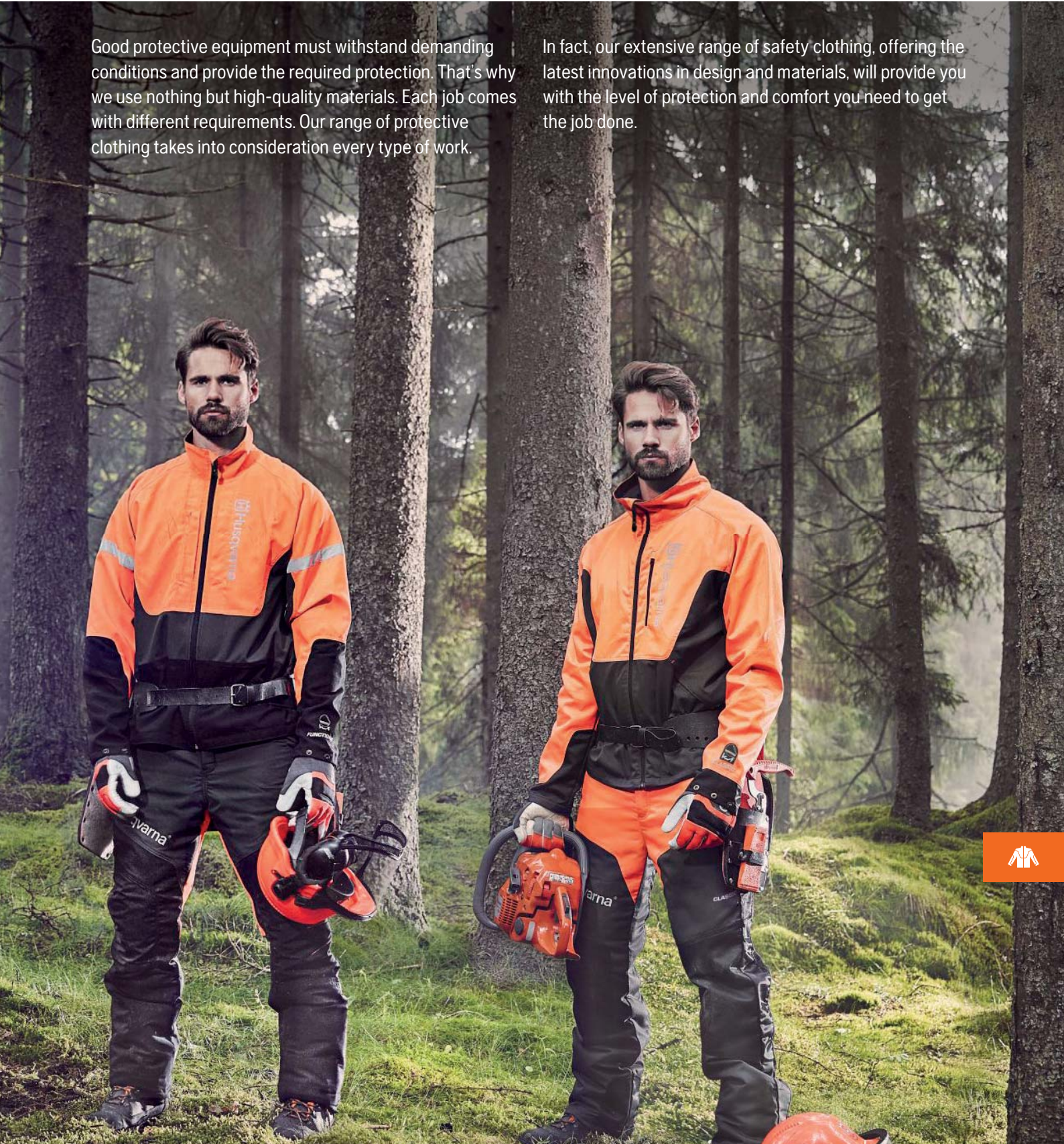

GRADED PROTECTION CLASS

All personal protection is ranked based on its ability to stop the chain at different speeds: Class 0 (16 m/s), Class 1 (20 m/s), Class 2 (24 m/s) and Class 3 (28 m/s). Tested and approved in accordance with European (CE) and International (ISO) standards.



TROUSER CUT PROTECTION AREAS

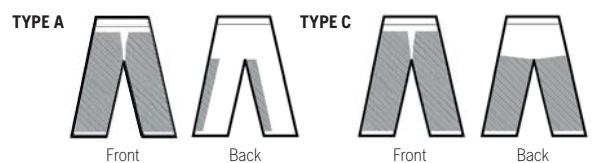

The shaded areas show the location of protective material.



MATERIALS CHOSEN FOR YOUR NEEDS

FULL-TIME USE



COMFORTABLE STRETCH

A 4-way stretch fabric that stretches in all directions, length-ways and across. The breathable fabric therefore gives you high movability in areas where it is needed, and provides comfortable movement. Available in our Technical range.

235 G/M². 92 % POLYESTER / 8 % LYCRA®.



ARAMIDE MÉLANGE

A fibre composition combining abrasion resistant Kevlar® fibres and hardwearing Cordura® fibres, making our Aramide mélange a tough fabric used for reinforcements on exposed areas.

Available in our Technical range.

240 G/M². 45 % CORDURA® / 30 % POLYAMID / 25 % KEVLAR® ARAMIDE.



CORDURA® REFLEX

Cordura® means durability without compromise. The fabric delivers the wear and tear resistance needed on the most exposed areas. The reflective yarn in the fabric gives high visibility in dark and dim conditions. Available in our Technical Extreme range.

335G/M². 100 % POLYAMIDE.



CORDURA® CHECKERED

The fabric delivers the wear and tear resistance needed on the most exposed areas. Coated on the back for improved water resistance.

Available in our Technical Extreme range.

225 G/M². 100 % POLYAMIDE.



LIGHT WEIGHT STRETCH

Our light 4-way stretch fabric stretches in all directions, length-ways and across. The breathable fabric therefore gives you high movability in areas where it is needed, and provides maximum comfort. Available in our Technical Extreme range.

190 G/M². 88 % POLYESTER (14% POLYESTER COOLMAX®) / 12% ELASTANE (LYCRA®).



FEATHER STRETCH

Our lightest fabric with 2-way stretch is used for areas in need of a great movability. The fabric gives freedom of movement and high comfort. Available in our Technical Extreme range.

185 G/M². 66 % POLYESTER / 34 % ELASTANE.

FULL-TIME USE





FIND YOUR SIZE

FOREST JACKETS / STANDARD SIZES

| SIZES | | S | M | L | XL | XXL | XXXL |
|-------|----------------|--------|--------|--------|--------|--------|--------|
| Male | Chest (inches) | 36-38" | 40-42" | 44-46" | 48-50" | 52-54" | 54-56" |

| SIZES | | XS | S | M |
|--------|----------------|--------|--------|--------|
| Female | Chest (inches) | 31-34" | 34-36" | 36-39" |

PROTECTIVE TROUSERS

| SIZES | 44 | 46/48 | 50/52 | 54/56 | 56/60 | 62 |
|---------------------|---------|---------|---------|---------|---------|-----|
| MODEL | XS | S | M | L | XL | XXL |
| Height (cm) | 170-176 | 170-176 | 176-182 | 176-182 | 182-188 | 188 |
| Waist (inches) | 31" | 32-34" | 35-36" | 37-38" | 39-40" | 42" |
| Inside leg (inches) | 31" | 31.5" | 32" | 32.5" | 33" | 33" |

| SHORT LEG | S-7 cm | M-7 cm | L-7 cm | XL-7 cm |
|---------------------|---------|---------|---------|---------|
| Height (cm) | 165-171 | 171-177 | 177-177 | 177-183 |
| Waist (inches) | 32" | 35" | 37" | 39" |
| Inside leg (inches) | 26.5" | 27" | 27.5" | 27.5" |

| LONG LEG | S+7 cm | M+7 cm | L+7 cm | XL+7 cm |
|---------------------|---------|---------|---------|---------|
| Height (cm) | 175-181 | 181-187 | 181-187 | 187-193 |
| Waist (inches) | 32" | 35" | 37" | 39" |
| Inside leg (inches) | 34" | 34.5" | 35" | 35.5" |

Note: All measurements are body measurements, except the inner leg, which is a garment measurement. If a base layer is to be worn under the garment, it should also be worn when measuring. Chest: measured around the widest part of the chest. Height: from top to toe. Waist: measured around the waist. Inside leg: measured from crotch to desired length.

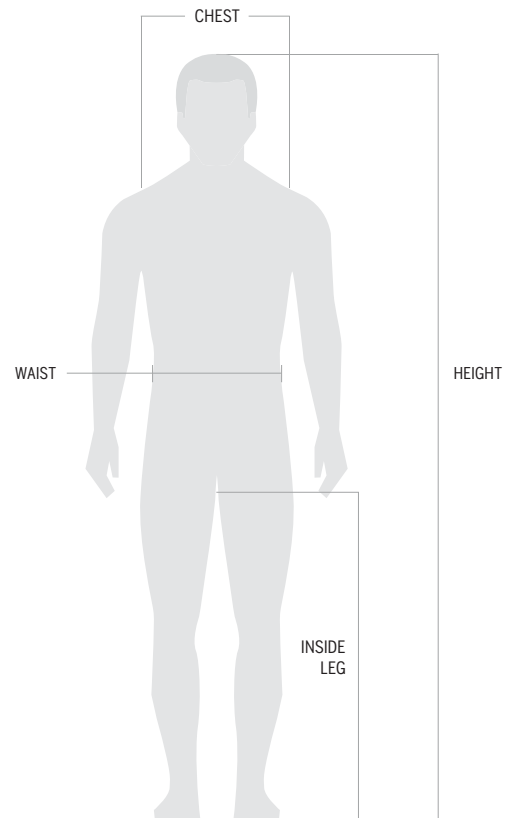

KEEP YOUR SAFETY CLOTHING SAFE

WASHING GUIDE

Your protective clothes are regularly exposed to sweat and oil. These substances can reach the protective layer, reducing its functionality. This is why you need to wash your clothes regularly and in accordance with their labelling. If your clothes get heavily soiled, you should wash them as soon as possible after use.



Wash the garment regularly in accordance with the instructions on the inside labelling.



Machine wash. For temperature, see inside labelling.



After washing, the garment should be stretched prior to drying. Air dry slowly.



Do not wash your protective clothes inside out. Also, do not bleach, dry clean, or tumble dry. Iron with low heat.



Clean the garment immediately if it has been subjected to petrol, oil, grease or other flammable materials. Fire hazard!



Keep the garment away from sharp objects, acids, oils, solvents, fuels and animal droppings.

REPAIR GUIDE

In addition to washing and cleaning your protective wear, you also need to check for heavily worn areas, damages and tears in the fabric. The protective functions may be seriously reduced if repairs are not carried out properly. Use the guide below for reference, and always consult your dealer if in doubt.



If a repair to the outer material is being made, do not sew into the protective material as this can reduce its protective qualities.



Damaged outer material must be repaired immediately in order to prevent the protective material becoming damaged.



The garment should be scrapped and not used again if the protective material has been: damaged, incorrectly washed, or altered from its original shape.



Adhesive must not be used when carrying out repairs as it may affect the protective material and reduce its protective qualities.



This product is no substitute for the operation of a chainsaw and does not provide total protection.

Cut-retardant apparel and materials are subject to a certain degree of aging. In professional logging, the maximum period of usage is considered to be about 12 months. In non-professional or occasional use, up to 5 years is considered acceptable.





TECHNICAL – FULL-TIME USE



TIGHT FIT



PRE-BENT KNEES

The knees are pre-bent and have been tailored to offer maximum mobility without compromising safety.



ADJUST FOR PERFECT FIT

The clothes come with elastic drawstrings at the waist and at the lower bottom of the jacket, allowing you to adjust your gear for a perfect fit.



STRETCH FOR COMFORT

Where needed, the clothes are made of stretch fabric, allowing you to move freely, safely and comfortably.



WELL VENTILATED

Openings at the yoke and the lower back make for good ventilation. Zips under the arms and at the back of the legs let you adjust the airflow to your liking.



REINFORCED WHERE YOU NEED IT

The knees, elbows, ankles and wrists have been reinforced to withstand tough use and make your clothes last longer.



EASY-ACCESS POCKETS

The jacket has two pockets on the chest and a dedicated first-aid pocket. The trousers feature two front pockets, two back pockets, a leg pocket and a double ruler pocket.

PROTECTIVE CLOTHING MADE FOR PROFESSIONAL PERFORMANCE

The Husqvarna Technical range is designed and built to perform all day every day for professional users. Task-optimised design meets modern styling, while tough, light stretch fabrics, reinforced panels and pre-bent knees and elbows offer high resistance, durability and performance.

Ideal for applications including:

- Forestry
- Logging
- Horticulture
- Arboriculture





TECHNICAL FOREST JACKET



Size (chest)
54 for 44-46"
46 for 36-38" **58 for 48-50"**
50 for 40-42" **62 for 52-54"**

Tough yet lightweight four-way stretch polyester with pre-bent sleeves ensures comfortable movement and reduced effort. Ventilation openings on the yoke and lower back, padded chest pocket and zip sleeve adjustment. With Aramide and Cordura® reinforcements.

| Order PNC | RRP ex VAT | RRP inc VAT |
|--------------|------------|----------------|
| 582 33 21-XX | £165.83 | £199.00 |

TECHNICAL ARBOR 20 JACKET



Size (chest)
54 for 44-46"
46 for 36-38" **58 for 48-50"**
50 for 40-42"

With EN381 Class 1 (20 m/s) cut protection. A crafted fit made from two-way stretch polyester with Aramide and Cordura® reinforcements. Enforcements from elbow to wrist. Velcro® adjustments at the end of the sleeves and elastic string at the waist and bottom gives all-day durable performance.

| Order PNC | RRP ex VAT | RRP inc VAT |
|--------------|------------|----------------|
| 594 99 88-XX | £232.50 | £279.00 |

TECHNICAL VENT JACKET



Size (chest)
54 for 44-46"
46 for 36-38" **58 for 48-50"**
50 for 40-42" **62 for 52-54"**

Designed for forest work in warmer conditions, the jacket is made from 100% knitted polyester under the arms and features pre-bent sleeves and a tight fit for working in the forest. With thin elastic bands around the waist and wrists.

| Order PNC | RRP ex VAT | RRP inc VAT |
|--------------|------------|----------------|
| 582 33 43-XX | £91.66 | £109.99 |

TECHNICAL HIGH VIZ JACKET



Size (chest)
54 for 44-46"
46 for 36-38" **58 for 48-50"**
50 for 40-42" **62 for 52-54"**

Tough, yet lightweight make this jacket ideal for everyday work in environments where visibility matters. Conforming to EN ISO20471 Class 3, it's made from lightweight stretch polyester, two-way ways on the front and four-ways on the back, with crafted fit.

| Order PNC | RRP ex VAT | RRP inc VAT |
|--------------|------------|----------------|
| 596 30 37-XX | £182.50 | £219.00 |

TECHNICAL PROTECTIVE TROUSERS 20A

Long
 (+ 7 cm leg)
Short
 (- 7 cm leg)



Size (waist)
45 for 32" S **54 for 37"**
46 for 32" **55 for 37" L**
47 for 32" L **57 for 39" S**
49 for 35" S **58 for 39"**
50 for 35" **59 for 39" L**
51 for 35" L **61 for 42" S**
53 for 37" S **62 for 42"**

With Aramide and Cordura® reinforcements in critical areas. Lightweight, stretch fabrics with pre-bent knees and ventilated back pockets with zips in a tight fit. **TYPE A, CLASS 1**



| Order PNC | RRP ex VAT | RRP inc VAT |
|--------------|------------|----------------|
| 594 99 90-XX | £190.83 | £229.00 |

TECHNICAL PROTECTIVE TROUSERS 20C



Size (waist)
46 for 32" **58 for 39"**
50 for 35" **62 for 42"**
54 for 37"

Type C trousers in grey colour way design. Lightweight with extended back, ventilated back pockets with Cordura® and Aramide reinforcements and a reinforced crotch. With Husqvarna logo on lower back leg. Fulfills EN 381 Class 1 (20 m/s).

TYPE C, CLASS 1



| Order PNC | RRP ex VAT | RRP inc VAT |
|--------------|------------|----------------|
| 595 00 07-XX | £233.33 | £279.00 |

TECHNICAL PROTECTIVE TROUSERS HI-VIZ 20A



Size (waist)
46 for 32" **58 for 39"**
50 for 35" **62 for 42"**
54 for 37"

For work along the roads or where you need more visibility. 4-way stretch where needed allows you to move freely, safely and comfortably. The pre-bent legs offer maximum mobility, the reflective straps high visibility and increased safety, whereas the reinforced knees and legs provide durability during tough use. Approved according to EN 381 class 1 (20 m/s) and EN ISO 20471 class 2.

TYPE A, CLASS 1



| Order PNC | RRP ex VAT | RRP inc VAT |
|--------------|------------|----------------|
| 595 08 72-XX | £190.83 | £229.00 |

TECHNICAL ROBUST TROUSERS 20A



Size (waist)
46 for 32" **58 for 39"**
50 for 35" **62 for 42"**
54 for 37"

Dyneema® fabric on the front and reinforcements on crotch in Aramide stretch and Cordura® around ankles. Tick protection around ankles and stretch fabric on trouser back ensures comfort and productivity. Fulfills EN 381 Class 1 (20 m/s).

TYPE A, CLASS 1



| Order PNC | RRP ex VAT | RRP inc VAT |
|--------------|------------|----------------|
| 594 99 86-XX | £199.17 | £239.00 |



TECHNICAL EXTREME – FULL-TIME USE



SLIM FIT

CORDURA[®] REFLEX

FEATHER STRETCH

LIGHT WEIGHT STRETCH

CORDURA CHECKERED

CORDURA[®] REFLEX

CORDURA CHECKERED

PROTECTIVE CLOTHING MADE FOR MAXIMUM PERFORMANCE

Husqvarna Technical Extreme is our ultimate range of protective clothing. Designed for full-time intensive use in the most demanding conditions. The Technical Extreme range has been developed solely to maximise your performance offering lightweight comfort, breathability and protection. With pre-bent knees, sleeves and a slim fit in durable stretch fabrics, the garments' smart, trade specific design enables maximum performance all day, every day.

Ideal for applications including:

- Professional forestry
- Logging
- Arboriculture



ADJUST FOR PERFECT FIT

The clothing comes with hook and loop wrist and ankle strap as well as elastic drawstrings at the waist and at the lower bottom of the jacket, allowing you to adjust your gear for a perfect fit.



KEEP YOUR TROUSERS IN PLACE

Attach the boot hook on the inside of the cuff to your laces, to keep them tightly secured.



BRACES INCLUDED

The trousers come with quality braces, so they stay safely and comfortably in place all day.



WELL VENTILATED

Openings at the yoke and the lower back make for good ventilation. Zips under the arms and at the back of the legs let you adjust the airflow to your liking.



EASY-ACCESS POCKETS

The jacket has two pockets on the chest, one on the sleeve, and a dedicated first-aid pocket. The trousers feature two front pockets, two back pockets, a leg pocket and a double ruler pocket.



POCKETS FOR YOUR MOBILE PHONE

The chest pockets have a padded lining for your mobile phone, keeping it well protected and within easy reach at all times.





TECHNICAL EXTREME FOREST JACKET



NEW FEMALE SIZES AVAILABLE

| | |
|--------------------------|----------------------|
| Size Male (chest) | Size Female |
| 42 for 31-34" | 42 for 31-34" |
| 46 for 36-38" | 46 for 34-36" |
| 50 for 40-42" | 50 for 36-39" |
| 54 for 44-46" | |
| 58 for 48-50" | |
| 62 for 52-54" | |

Lightweight, breathable fabrics with pre-bent elbows and padded chest pocket, zipped sleeve pocket and Velcro® adjustable cuffs. The Technical Extreme Forest Jacket features high visibility fabrics and reflex bands in a slim fit. Available in both male and female sizes.

| | Order PNC | RRP ex VAT | RRP inc VAT |
|--------|--------------|------------|----------------|
| Male | 582 33 10-XX | £232.50 | £279.00 |
| Female | 582 34 07-XX | £232.50 | £279.00 |

TECHNICAL EXTREME PROTECTIVE TROUSERS 20A



Size (waist)
42 for 30" **62 for 42"**
46 for 32"
50 for 35"
54 for 37"
58 for 39"

Slim fit with lightweight stretch and Cordura® reinforcement in critical areas. With Tech-Knee and ventilation openings which provide protection and durability. With an adjustable waist, reflex tapes and Husqvarna logo on lower back leg. Fulfills EN 381 Class 1 (20 m/s).

TYPE A, CLASS 1

| | Order PNC | RRP ex VAT | RRP inc VAT |
|--|--------------|------------|----------------|
| | 594 99 68-XX | £265.83 | £319.00 |

TECHNICAL EXTREME PROTECTIVE ARBOR TROUSERS 20A



Size (waist)
42 for 30" **54 for 37"**
46 for 32" **58 for 39"**
50 for 35" **62 for 42"**

Designed for the challenges of climbing and working in trees, the Technical Extreme Arbor trouser offers a combination of safety, agility and function. With strong and light Dyneema®, Cordura® and Kevlar® reinforcements it is made to withstand wear in areas most needed. The design combines the key features of the Technical Extreme range with features adapted to the needs of arborists to fit with climbing gear. Size S-XL.

EN381 TYPE A, CLASS 1



EXTENDED LEG

An extra three centimetres has been added to make sure the trouser stays over the boot when climbing, for protection and comfort.



EASY ACCESS POCKETS

Side pockets with reversed zips for easy access when wearing harness, and double thigh pockets with loops for storage.

| | Order PNC | RRP ex VAT | RRP inc VAT |
|--|--------------|------------|----------------|
| | 595 21 77-XX | £265.83 | £319.00 |



! TECH-KNEE TECHNOLOGY. EXCEPTIONAL PROTECTION AND MOBILITY

ADDED PROTECTIVE LAYERS

The Tech-Knee provides excellent saw protection, thanks to the additional fibre layers. This improves safety, especially in situations where the trousers fit tight to the knee.

WATER REPELLENT

The knee has a water-resistant inner lining and an outer layer made of water-repellent fabric, keeping water and moisture from penetrating the saw protection layers. This means you can work comfortably in wet conditions for a longer time.

PRE-BENT FABRIC

The complete knee, including the waterproof layers and saw protection fabric, has been pre-bent to ensure a perfect fit in all working positions.





TECHNICAL FOR BRUSHCUTTING



SPECIALLY DESIGNED FOR CLEARING AND GARDEN WORK

Wearing a harness while working long hours with a brushcutter puts specific demands on the clothes to be comfortable and functional. Our brushcutter and trimmer clothing offers practical details in the right places, like padded shoulders and hips and ventilation zips for durable protection whilst you work.

Ideal for applications including:

- **Trimming / brushcutting / hedge trimming**
- **Grounds maintenance**
- **Non chainsaw applications**

TECHNICAL BRUSHCUTTING/TRIMMING JACKET

NEW



Size (chest)
46 for 36-38"
50 for 40-42"
54 for 44-46"
58 for 48-50"
62 for 52-54"

High visibility jacket approved to EN ISO 20471 Class 3. Features shoulders with padded pockets which reduce fatigue, easily accessible pockets while using a harness and pre-bent arms. Ventilation zippers under the arms and ventilation yoke in the back with 4-way stretch fabric.

| Order PNC | RRP ex VAT | RRP inc VAT |
|--------------|------------|----------------|
| 597 66 02-XX | £91.66 | £109.99 |

TECHNICAL BRUSHCUTTING/TRIMMING TROUSERS

NEW



Size (waist)
46 for 32" 54 for 37"
48 for 34" 56 for 38"
50 for 35" 58 for 39"
52 for 36" 60 for 40"

Trousers especially designed for working long hours with brushcutter or trimmer. High visibility approved to EN ISO 20471 Class 2. Feature extra padding in the hip and water repellent material at front and side of the legs with extra padding against thrown debris. Surface treated fabric lets you just brush off wet grass. Reinforcements on exposed areas increase durability and lifespan. Ventilation zippers on back of the legs.

| Order PNC | RRP ex VAT | RRP inc VAT |
|--------------|------------|---------------|
| 597 66 06-XX | £83.33 | £99.99 |



EXTRA REINFORCEMENT

Shoulder and hip reinforcement for increased durability when using a harness all day.



WELL-VENTILATED

Ventilation zips under the arms and on the back of the trouser legs for a comfortable temperature.

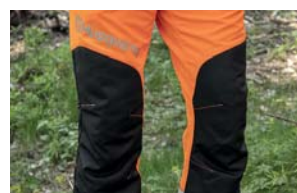

PRE-BENT

Trouser knees with Cordura® reinforcements for durability. A water repellent material in front and on the sides of the legs with padded protection.



TECHNICAL RAIN VENT JACKET



NEW

Size
 42 for X Small
 46 for Small
 50 for Medium
 54 for Large
 58 for X Large
 62 for XX Large

High-quality rain jacket with reinforced exposed areas. Water-repellent yet breathable thanks to laminate and taped seams. Made from durable polyester with mechanical stretch. Detachable hood, adjustable waist, pockets feature waterproof zip. EN ISO20471 Class 3 & EN343.

| Order PNC | RRP ex VAT | RRP inc VAT |
|--------------|------------|----------------|
| 597 66 26-XX | £157.50 | £189.00 |

FUNCTIONAL RAIN JACKET HI-VIZ



NEW

Size
 42 for X Small
 46 for Small
 50 for Medium
 54 for Large
 58 for X Large

Polyester knitting, durable one-sided PU coating with welded seams. Enables airflow in the jacket for long working hours. EN ISO 20471 Class 3 EN343.

| Order PNC | RRP ex VAT | RRP inc VAT |
|--------------|------------|----------------|
| 597 66 28-XX | £91.66 | £109.99 |

FUNCTIONAL RAIN BACK PROTECTOR - ONE SIZE



NEW

Back Protector made from a polyester knitting with a durable one-sided PU coating with welded seams. Designed for working positions while operating with a chainsaw. EN343. One size.

| Order PNC | RRP ex VAT | RRP inc VAT |
|--------------|------------|---------------|
| 597 66 32-10 | £41.66 | £49.99 |

TECHNICAL RAIN VENT TROUSERS



NEW

Size
 42 for X Small
 46 for Small
 50 for Medium
 54 for Large
 58 for X Large
 62 for XX Large

High-quality rain trousers, durable laminated polyester fabric with mechanical stretch, taped seams, reinforcement fabric over the areas from above the knee and lower inside leg. Elastic hem at back with hook and loop attachments on the sides for easy adjustment and perfect fit. EN343.

| Order PNC | RRP ex VAT | RRP inc VAT |
|--------------|------------|---------------|
| 597 66 27-XX | £79.16 | £94.99 |

FUNCTIONAL RAIN TROUSERS HI-VIZ



NEW

Size
 42 for X Small
 46 for Small
 50 for Medium
 54 for Large
 58 for X Large

Rain trousers made from a polyester knitting with a durable one-sided PU coating with welded seams. Zippers at the side for easy access. EN ISO 20471 Class 2 and EN343.

| Order PNC | RRP ex VAT | RRP inc VAT |
|--------------|------------|---------------|
| 597 66 29-XX | £58.33 | £69.99 |

FUNCTIONAL RAIN CHAPS HI-VIS - ONE SIZE



NEW

Rain chaps made from a polyester knitting with a durable one-sided PU coating and welded seams. Attached to a belt or a tool belt. EN ISO20471 Class 1 and EN343. One size.

| Order PNC | RRP ex VAT | RRP inc VAT |
|--------------|------------|---------------|
| 597 66 33-10 | £37.49 | £44.99 |



TECHNICAL WORK T-SHIRTS



Size
 46 for Small
 50 for Medium
 54 for Large
 58 for X Large
 62 for XX Large
 66 for XXX Large

Light and cool, with zipped front, extended back and easy-access zipped front pocket. It transports moisture away from the body and dries quickly. Available in long and short sleeves.

Technical Hi-Viz T-Shirt features additional reflective tape and is tested and approved to ISO EN 20471 (Class 2).

| Item | Order PNC | RRP ex VAT | RRP inc VAT |
|-------------------------|--------------|------------|---------------|
| Short Sleeve NEW | 597 66 11-XX | £29.16 | £34.99 |
| Long Sleeve NEW | 597 66 12-XX | £36.66 | £43.99 |
| Hi-Viz Short Sleeve | 596 30 39-XX | £33.33 | £39.99 |
| Hi-Viz Long Sleeve | 596 30 38-XX | £41.66 | £49.99 |

WORK SHIRT



Size
 37 for Small
 39 for Medium
 41 for Large
 43 for X Large
 45 for XX Large

A soft and comfortable shirt for work or leisure. Made of 100% pre-shrunk cotton.

| Order PNC | RRP ex VAT | RRP inc VAT |
|--------------|------------|---------------|
| 578 78 57-XX | £27.49 | £32.99 |



FOOTWEAR



PROTECTIVE FOOTWEAR FOR MAXIMUM COMFORT AND STABILITY

We offer a comprehensive range of foot protection. Close co-operation with professionals forms the basis of the research and development behind our purpose designed footwear.

All protective footwear is VAT exempt.

SIZE AVAILABILITY

| Variant - UK size | TPB | C20 / FB24 | T24 | F24 | F28 |
|-------------------|-----|------------|-----|-----|-----|
| 36 - 3.5 | • | | • | | |
| 37 - 4 | • | | • | • | • |
| 38 - 5 | • | | • | • | • |
| 39 - 5.5 | • | • | • | • | • |
| 40 - 6.5 | • | • | • | • | • |
| 41 - 7.5 | • | • | • | • | • |
| 42 - 8 | • | • | • | • | • |
| 43 - 9 | • | • | • | • | • |
| 44 - 9.5 | • | • | • | • | • |
| 45 - 10.5 | • | • | • | • | • |
| 46 - 11 | • | • | • | • | • |
| 47 - 12 | • | • | • | • | • |
| 48 - 13 | | | • | | • |
| 49 - 13.5 | | | | | • |

WITH SAW PROTECTION

CLASSIC 20 CHAINSAW LEATHER BOOTS (C20)



Lightweight and robust leather boots with reinforced toe and heel. The removable soles are washable. With saw protection 20 m/s.

| | |
|--------------|----------------|
| Order PNC | RRP ex VAT |
| 597 65 94-XX | £169.99 |

FUNCTIONAL 24 CHAINSAW LEATHER BOOTS (FB24)

NEW



Water repellent, lightweight with reinforcements for increased support TE-POR membrane keeps the feet dry and Vibram® sole. With saw protection 24 m/s.

| | |
|--------------|----------------|
| Order PNC | RRP ex VAT |
| 597 65 93-XX | £239.00 |

TECHNICAL 24 CHAINSAW LEATHER BOOTS (T24)



With composite toe cap. Made of nylon mesh and high quality leather Sympatex® membrane, the boots are 100% waterproof. With saw protection 24 m/s.

| | |
|--------------|----------------|
| Order PNC | RRP ex VAT |
| 597 65 92-XX | £269.00 |

FUNCTIONAL 24 RUBBER CHAINSAW BOOTS (F24)



Class 2 (24 m/s) saw protection. Features include steel toe cap, ankle protection, heel ridges and non-slip sole. Can fit studs.

| | |
|--------------|---------------|
| Order PNC | RRP ex VAT |
| 595 00 28-XX | £69.99 |

FUNCTIONAL 28 RUBBER CHAINSAW BOOTS (F28)



Class 3 (28 m/s) saw protection. Features include steel toe cap, ankle protection, heel ridges and non-slip sole. Can fit studs.

| | |
|--------------|---------------|
| Order PNC | RRP ex VAT |
| 595 00 24-XX | £84.99 |

WITHOUT SAW PROTECTION

TECHNICAL PROTECTIVE BOOTS (TPB)



Made from high quality waterproof leather/nylon mesh. The Sympatex membrane makes the boots 100% waterproof, with pull strap at the tongue and back of the boot.

| | |
|--------------|----------------|
| Order PNC | RRP ex VAT |
| 597 65 95-XX | £129.99 |

FOOTWEAR ACCESSORIES

| Item | Order PNC | RRP ex VAT | RRP inc VAT |
|---|--------------|------------|---------------|
| Boot Dryers (11m cable, 4 + 4 W/ 230 V. CE approved.) | 544 96 40-01 | £16.66 | £19.99 |
| Studs (50 pcs, inc stud key) | 587 25 81-01 | £14.99 | £17.99 |
| Boot Laces | 579 30 10-01 | £5.83 | £6.99 |

PROTECTIVE LEATHER BALM 200ml

NEW

Perseveres the leather, keeps it soft and comfortable and gives it a water and dirt repellent surface. Use it on your leather boots and gloves. Contains wool fat, beeswax, Vaseline® and mink oil.

| | | |
|--------------|------------|--------------|
| Order PNC | RRP ex VAT | RRP inc VAT |
| 590 65 22-01 | £7.49 | £8.99 |





WORK GLOVES



GLOVES THAT MATCH YOUR REQUIREMENTS

We offer the latest in gloves, specially designed for every type of work. Gardener, forestry worker or arborist? You decide what you need for the work you are doing. Our range of gloves covers every requirement.

WITHOUT SAW PROTECTION

CLASSIC LIGHT GLOVES



Variant - cm
(palm width)
06 - 6 cm
07 - 7 cm
08 - 8 cm
09 - 9 cm
10 - 10 cm



Goat leather palm with jersey fabric on the back. Suitable for many different types of jobs. Tight fit.

| Order PNC | RRP ex VAT | RRP inc VAT |
|--------------|------------|---------------|
| 596 31 06-XX | £12.49 | £14.99 |

TECHNICAL GLOVES



Variant - cm
(palm width)
09 - 9 cm
10 - 10 cm
12 - 12 cm



Goat leather palm with interlock jersey and grey foam. Laminated Spandex fabric on back. Comfortable seams and double thumb stitching. Tight fit.

| Order PNC | RRP ex VAT | RRP inc VAT |
|--------------|------------|---------------|
| 596 30 67-XX | £20.83 | £24.99 |

WITH SAW PROTECTION

FUNCTIONAL 16 GLOVES



Variant - cm
(palm width)
07 - 7 cm
08 - 8 cm
09 - 9 cm
10 - 10 cm
12 - 12 cm



Class 0 (16 m/s) chainsaw protection. Goat leather double palm with foam laminated Spandex on the back and nylon neoprene knuckles.

| Order PNC | RRP ex VAT | RRP inc VAT |
|--------------|------------|---------------|
| 595 00 39-XX | £23.33 | £27.99 |

TECHNICAL 20 GLOVES



Variant - cm
(palm width)
08 - 8 cm
09 - 9 cm
10 - 10 cm



Class 1 (20 m/s) chainsaw protection with goat leather palm with interlock jersey and grey foam. Laminated Spandex fabric on back with comfortable seams and double thumb stitching.

| Order PNC | RRP ex VAT | RRP inc VAT |
|--------------|------------|---------------|
| 595 00 34-XX | £31.66 | £37.99 |



COMFORTABLE SEAMS

Inside in goat skin. Made with comfortable seams with double thumb stitching that follows the hand shape.



REINFORCED TRIGGER FINGER

Reinforced trigger finger in goatskin leather.





HEAD, FACE AND EAR PROTECTION



YOUR HEAD, EYES AND EARS DESERVE PROFESSIONAL PROTECTION

Extensive research, technological product development as well as close, long lasting co-operation with professional users allows us to offer an excellent combination of ergonomically designed equipment.

All protective helmets are VAT exempt.



CLASSIC FOREST HELMET



Helmet with six-point plastic harness and one-hand adjustable slip ratchet. The harness depth is also adjustable in three steps for individual fit. The hearing protectors are developed for optimal ergonomics, and a metal mesh visor that provides good protection and good visibility.

| Order PNC | SNR (dB) | RRP ex VAT |
|--------------|----------|---------------|
| 580 75 43-01 | 27dB | £39.99 |

FUNCTIONAL FOREST HELMET



High specification helmet with 6-point harness for comfort and less pressure. It features the UltraVision visor with only 20% light reduction giving a clearer view and ergonomic hearing protectors.

| Order PNC | SNR (dB) | RRP ex VAT |
|--------------------|----------|---------------|
| 576 41 24-02 | 26dB | £59.99 |
| 576 41 24-01 | 26dB | £59.99 |
| Fluorescent Orange | | |

TECHNICAL ARBORIST HELMET



Lightweight and breathable helmet for professional arborists. Approved for working at heights. Harness adjustment with two wheels that centres the head in the helmet for best balance, stability and comfort.

| Order PNC | SNR (dB) | RRP ex VAT |
|--------------|----------|----------------|
| 578 09 23-01 | 26dB | £109.99 |

TECHNICAL FOREST HELMET



Lightweight and well ventilated- an ergonomically exceptional helmet for foresters packed with smart solutions that lessen the weight, enable a more personal fit and ensure a better head temperature even during long shifts. It also offers an improved field of vision and a headlamp slot.

| Order PNC | SNR (dB) | RRP ex VAT |
|----------------|----------|----------------|
| 585 05 84-01 | 26dB | £109.99 |
| 595 08 43-01 | 26dB | £319.00 |
| (with X-COM R) | | |

SPIRE VENT ARBORIST HELMET

NEW



Husqvarna arborist helmet Spire Vent is designed for the professional arborist who requires convenience and style at work without compromising safety and protection. The Spire Vent helmet is lightweight and well ventilated for maximum comfort. It has a universal fit and a wheel ratchet for easy size adjustment. Also equipped with attachments for mounting headlamps, ear muffs and visors. Compatible with Husqvarna ear muffs and three Husqvarna visor styles, including clear, mirror and smoke (all sold separately). Fulfills European standard EN 12492 for work at heights.

| | Item | Order PNC | RRP ex VAT | RRP inc VAT |
|---|-----------------------------|--------------|------------|----------------|
| 1 | Spire Vent Arborist Helmet | 597 68 18-01 | £83.33 | £99.99 |
| 2 | Clear Visor for Spire Vent | 598 86 23-01 | £41.66 | £49.99 |
| 3 | Smoke Visor for Spire Vent | 598 86 23-02 | £45.83 | £54.99 |
| 4 | Mirror Visor for Spire Vent | 598 86 23-03 | £58.33 | £69.99 |
| 5 | Hearing Protection X-COM R | 595 08 42-01 | £190.83 | £229.99 |
| 6 | Hearing Protection Standard | 587 44 24-01 | £20.83 | £24.99 |
| | Hearing Protection Adaptor* | 599 29 72-01 | £2.49 | £2.99 |

*Required to fit hearing protection



VISOR FOR TECHNICAL HELMET



Etched visor with low light reduction and improved design that encloses the face for extended protection from all directions. Will fit Technical Forest helmet only.

| Order PNC | RRP ex VAT | RRP inc VAT |
|--------------|------------|---------------|
| 586 40 96-01 | £23.33 | £27.99 |

ULTRAVISION VISOR



Light reduction is only 20% over the whole mesh area. Less sensitive for water to stick on the mesh and permanent deformation.

| Order PNC | RRP ex VAT | RRP inc VAT |
|--------------|------------|---------------|
| 574 61 35-01 | £16.66 | £19.99 |

METAL MESH VISOR



Fits all our helmets and hearing protectors. Excluding Technical Forest helmet.

| Order PNC | RRP ex VAT | RRP inc VAT |
|--------------|------------|---------------|
| 505 66 53-21 | £9.99 | £11.99 |

NYLON MESH VISOR



Fits all our helmets and hearing protectors. Excluding Technical Forest helmet.

| Order PNC | RRP ex VAT | RRP inc VAT |
|--------------|------------|---------------|
| 505 66 53-19 | £9.99 | £11.99 |

PERSPEX VISOR



Fits all our helmets and hearing protectors. Excluding Technical Forest helmet.

| Order PNC | RRP ex VAT | RRP inc VAT |
|--------------|------------|--------------|
| 505 66 53-43 | £8.33 | £9.99 |

ANTI-FOG VISOR



Scratch-resistant polycarbonate visor with anti-fog treatment inside. For all our helmets and hearing protectors. Excluding Technical Forest helmet.

| Order PNC | RRP ex VAT | RRP inc VAT |
|--------------|------------|---------------|
| 505 66 53-63 | £14.99 | £17.99 |

HYGIENE KITS



Designed to fit our FM radio hearing protectors and Functional forest helmets.

| Item | Order PNC | RRP ex VAT | RRP inc VAT |
|------------|--------------|------------|---------------|
| Functional | 505 66 53-26 | £8.33 | £9.99 |
| FM Radio | 505 66 53-91 | £8.33 | £9.99 |
| X-COM R | 596 48 94-01 | £10.83 | £12.99 |

BOOM MIC FOR X-COM



| Order PNC | RRP ex VAT | RRP inc VAT |
|--------------|------------|---------------|
| 596 48 95-01 | £49.99 | £59.99 |

| HELMET TYPE | PNC | DESCRIPTION | RRP EX VAT | RRP INC VAT |
|--------------------------|--------------|-------------------------------|------------|---------------|
| Functional Forest Helmet | 575 55 76-02 | Harness Assy | £313 | £3.76 |
| Functional Forest Helmet | 575 55 73-01 | Sweatband Assy | £1.04 | £1.25 |
| Functional Forest Helmet | 582 17 04-01 | Chin Strap | £4.16 | £4.99 |
| Functional Forest Helmet | 578 17 98-01 | Sun Peak | £3.33 | £3.99 |
| Functional Forest Helmet | 505 66 53-28 | Visor Holder | £10.12 | £12.14 |
| Functional Forest Helmet | 505 67 53-40 | Holder for Hearing Protectors | £0.67 | £0.80 |
| Technical Forest Helmet | 586 40 96-01 | Visor | £25.42 | £30.50 |
| Technical Forest Helmet | 587 26 30-01 | Link Arm Kit | £13.64 | £16.37 |
| Technical Forest Helmet | 582 05 50-02 | Ratchet Kit Front | £5.90 | £7.08 |
| Technical Forest Helmet | 587 25 32-01 | Ratchet Wheel Kit | £4.57 | £5.48 |
| Technical Forest Helmet | 582 05 50-01 | Ratchet Kit Rear | £5.90 | £7.08 |
| Technical Forest Helmet | 583 87 08-01 | Forehead Pad | £3.39 | £4.08 |
| Technical Forest Helmet | 581 75 43-01 | Neck Protection Assy | £14.99 | £17.99 |
| Technical Forest Helmet | 581 50 82-01 | Sun Peak Visor | £4.16 | £4.99 |





PERSONAL PROTECTIVE EQUIPMENT

X-COM R HEARING PROTECTION WITH BLUETOOTH



The Husqvarna X-COM R with Bluetooth enables you to take and make phone calls, connect to an external intercom radio or listen to the music of your choice, directly in your hearing protection. Large talk button for easy operation and internal FM radio antenna. Boom mic available as an accessory. Please see page 177.

| Item | Order PNC | RRP ex VAT | RRP inc VAT |
|------------------|--------------|------------|----------------|
| Headband Mounted | 595 08 40-01 | £199.17 | £239.00 |
| Helmet Mounted | 595 08 42-01 | £199.17 | £239.00 |

HEARING PROTECTION WITH HEADBAND



Hearing protection where you can adjust the pressure by 20%. With soft, airy padding in the headband and an ergonomic design. The ear covers are the same as for our helmets. Available as a headband and helmet set. Common helmet set will fit Classic, Functional and Arborist helmets.

| Item | Order PNC | SNR (dB) | RRP ex VAT | RRP inc VAT |
|----------------------|--------------|----------|------------|---------------|
| Headband | 505 66 53-04 | 27dB | £23.33 | £27.99 |
| Common Helmet Set | 505 66 53-25 | 26dB | £20.83 | £24.99 |
| Technical Helmet Set | 587 44 24-01 | 26dB | £20.83 | £24.99 |

HEARING PROTECTORS WITH FM RADIO



Hearing protection with built-in FM Radio with improved sound quality and ergonomic headband. 3.5mm AUX input for audio and communication radio.

| Item | Order PNC | SNR (dB) | RRP ex VAT | RRP inc VAT |
|----------|--------------|----------|------------|----------------|
| Headband | 578 27 49-03 | 27dB | £91.66 | £109.99 |
| Helmet | 578 27 49-04 | 27db | £91.66 | £109.99 |

HEARING PROTECTION WITH VISOR AND COVER



Comfortable hearing protectors where you can adjust the pressure by 20%. Ideal for clearing grass and trimming. Features a cover between the visor and headband protecting your head from grass and rain. Can be used in combination with protective glasses. Can also be fitted with a sun peak.

| Item | Order PNC | SNR (dB) | RRP ex VAT | RRP inc VAT |
|--------------------|--------------|----------|------------|---------------|
| With perspex visor | 505 66 53-48 | 27dB | £33.33 | £39.99 |
| With mesh visor | 505 66 53-58 | 27dB | £33.33 | £39.99 |

GARDENER HEARING PROTECTION



Developed for garden work. Light and comfortable with extra wide headband. Also available with a perspex or mesh visor.

| Item | Order PNC | SNR (dB) | RRP ex VAT | RRP inc VAT |
|--------------------|---------------|----------|------------|---------------|
| Basic model | 505 69 90-12* | 25dB | £12.49 | £14.99 |
| With perspex visor | 505 66 53-60 | 25dB | £20.83 | £24.99 |

PROTECTIVE GLASSES



Protective glasses with non-scratch lenses. Meets requirements of EN 166.

| Item | Order PNC | RRP ex VAT | RRP inc VAT |
|-------|--------------|------------|---------------|
| Clear | 544 96 38-01 | £7.49 | £8.99 |
| Sun | 544 96 38-02 | £9.16 | £10.99 |

PROTECTIVE GOGGLES



Developed for people who wear glasses, featuring anti-fog coated lenses and a soft inside for greater comfort. Durable against impact, dust and airborne particles.

| Item | Order PNC | RRP ex VAT | RRP inc VAT |
|---------|--------------|------------|---------------|
| Goggles | 544 96 39-01 | £14.99 | £17.99 |

PROTECTIVE GLASSES X



Scratch resistant glasses with frames that can be extended and angled. The yellow tinted lenses give improved vision in dark conditions and the grey tinted lenses, with UV protection, give improved vision in sunny conditions.

| Item | Order PNC | RRP ex VAT | RRP inc VAT |
|----------|--------------|------------|---------------|
| Clear X | 544 96 37-01 | £9.99 | £11.99 |
| Yellow X | 544 96 37-02 | £11.66 | £13.99 |
| Sun X | 544 96 37-03 | £11.66 | £13.99 |

*PNC is for 1 x pack of 10 Gardner Hearing Protection. Please note, price is for single item



OPTIMISE YOUR MACHINES PERFORMANCE



RIGOROUS TESTING

At Husqvarna, we test oils in hot temperatures to see if the machine stays lubricated, and in the cold, to check it starts easily.



VERIFIED ENGINE FORMULA

We also test for thousands of hours in real life field tests. Only the oils that fulfill our strict requirements get the VEF label.



PROVEN PERFORMANCE

Compared to other oils, Husqvarna oils have been proven to leave less deposits on the pistons. Reducing damage at high temperatures.

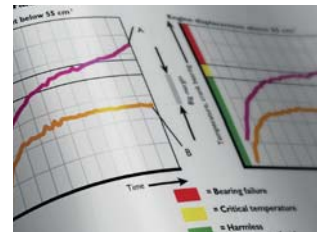

THE RIGHT TEMPERATURE

Oils are developed and continually tested to keep the right temperature and to ensure that your engine gets the optimum lubrication it needs.





BETTER FOR YOU, BETTER FOR YOUR HUSQVARNA

There is no better fuel for your Husqvarna product than our alkylate petrol manufactured to unique Husqvarna specifications. Our new XP® Power 2 is conveniently pre-mixed with exactly 2% of Husqvarna XP® synthetic 2-stroke oil, providing efficient combustion leaving a cleaner, cooler, healthier engine with minimal harmful substances in the emissions. It also prevents inner corrosion, makes starting easier, reduces the need for service and minimises downtime. VEF approved.



GIVE YOUR HUSQVARNA ENGINE THE BEST CONDITIONS TO DELIVER ITS FULL POTENTIAL.

- ✓ Prevents downtime
- ✓ Extends product lifetime
- ✓ Reduces need for service
- ✓ Easy start of the engine
- ✓ Long storage shelf life
- ✓ No more mixing (XP® Power 2)
- ✓ VEF – Verified Engine Formula (XP® Power 2)
- ✓ Healthier working environment
- ✓ Increases productivity and safety due to a clear mind the full working day.
- ✓ Reduces carbon footprint

DID YOU KNOW?

Our XP® Power 2 has almost no aromatics, benzene or olefins and extremely low fluorine content meaning that it is less corrosive than other fuels and one of the cleanest alkylate fuels, giving your product optimal performance; improving power, torque and startability.





HUSQVARNA XP® POWER 2



Alkylate petrol developed specifically for Husqvarna two-stroke engines. Pre-mixed with 2% of premium Husqvarna XP® synthetic 2-stroke oil (50:1). Provides efficient combustion for a clean, healthy engine with a minimum of harmful substances in the emissions. Simplifies starting and increases productivity by allowing a healthier working environment. VEF approved. Recommended shelf life is 2 years*.

| Item | Order PNC | RRP ex VAT | RRP inc VAT |
|-----------|--------------|------------|----------------|
| 1 Litre | 589 22 76-01 | £4.41 | £5.29 |
| 5 Litre | 582 20 20-05 | £16.66 | £19.99 |
| 25 Litre | 583 95 29-02 | £79.16 | £94.99 |
| 200 Litre | 583 95 29-04 | £582.50 | £699.00 |

HUSQVARNA POWER 4



Alkylate petrol developed to work with 4-stroke engines. Provides efficient combustion for a clean, healthy engine with a minimum of harmful substances in the emissions. Simplifies starting and increases productivity by allowing a healthier working environment. Recommended shelf life is 2 years*.

| Item | Order PNC | RRP ex VAT | RRP inc VAT |
|-----------|--------------|------------|----------------|
| 1 Litre | 589 22 79-01 | £4.16 | £4.99 |
| 5 Litre | 583 95 59-01 | £15.83 | £18.99 |
| 25 Litre | 583 95 59-02 | £74.99 | £89.99 |
| 200 Litre | 589 22 79-40 | £540.83 | £649.00 |

HUSQVARNA POWER FILLER SPOUT



Filler spout specifically designed when working with Husqvarna XP® Power 2 and Power 4, 5 Litre bottles. For quick and easy pouring.

| Order PNC | RRP ex VAT | RRP inc VAT |
|--------------|------------|---------------|
| 582 06 66-01 | £14.16 | £16.99 |

ACTIVE CLEAN SPRAY 500ML



Versatile cleaning spray, effective on saw chains, garden machines, air filters, and dirty boots. Husqvarna Active Clean Spray contains a specially-developed detergent that is phosphate-free and biodegradable.

| Order PNC | RRP ex VAT | RRP inc VAT |
|--------------|------------|--------------|
| 597 25 57-01 | £8.33 | £9.99 |

*Recommended Ideal storage conditions is in a cool, dry and dark place.



OILS & LUBRICANTS



ENGINEERED TO OPTIMISE YOUR HUSQVARNA

2-stroke chainsaw engines can run at 14,000 rpm, often under heavy load. At Husqvarna we design our engines to be durable and powerful, whilst also lightweight. This places special requirements on the oil – so it's vital to choose the right one. Husqvarna 2-stroke oils that meet our strict requirements are labelled VEF – Verified Engine Formula.

HP 2-STROKE ENGINE OIL



Formulated to work well with low-quality fuels and to meet all the tough challenges a 2-stroke engine oil can encounter. Carefully selected components in this part synthetic oil gives a cleaner engine and less coating on the piston/cylinder walls, exhaust port and crankcase. VEF approved.

| Volume | Order PNC | RRP ex VAT | RRP inc VAT | Dealer Information |
|-----------|--------------|------------|------------------|------------------------|
| 01 Litre | 587 80 85-01 | £1.66 | £1.99 | Shipped in packs of 50 |
| 1L Dosage | 587 80 85-11 | £7.49 | £8.99 | Shipped in packs of 12 |
| 4 Litre | 587 80 85-20 | £22.49 | £26.99 | Shipped in packs of 4 |
| 20 Litre | 587 80 85-30 | £99.99 | £119.99 | - |
| 208 Litre | 587 80 85-40 | £999.17 | £1,199.00 | - |

LS+ 2-STROKE ENGINE OIL



LS+ oil is a mix of mineral and synthetic oils. Low smoke and has extremely good lubrication qualities on high load engine components, such as the connecting rod and bearings. It is best used for chainsaws and clearing saws with a cylinder volume up to 55 cm³. It also lowers the engine temperature which extends engine life and gives a very good seizure protection against lean mix as well as carbon related piston seizures. VEF approved.

| Volume | Order PNC | RRP ex VAT | RRP inc VAT | Dealer Information |
|-----------|--------------|------------|------------------|------------------------|
| 01 Litre | 578 18 03-02 | £1.91 | £2.29 | Shipped in packs of 50 |
| 1L dosage | 578 03 70-02 | £9.16 | £10.99 | Shipped in packs of 12 |
| 4 Litre | 578 03 71-02 | £29.99 | £35.99 | Shipped in packs of 3 |
| 10 Litre | 578 18 00-02 | £66.66 | £79.99 | - |
| 208 Litre | 578 18 04-02 | £1,332.50 | £1,599.00 | - |

XP® 2-STROKE ENGINE OIL



An excellent, fully synthetic and biodegradable 2-stroke oil, developed for tough use with high loads and engine speed. Developed with a completely new ash-free wear additive which gives extremely good lubrication, low smoke, a cleaner engine and less coating on the piston and in the crankcase compared to competing oils. Appropriate for all Husqvarna products, especially for engines with a cylinder volume over 55 cm³. VEF approved.

| Volume | Order PNC | RRP ex VAT | RRP inc VAT | Dealer Information |
|-----------|--------------|------------|------------------|------------------------|
| 01 Litre | 578 18 03-03 | £2.49 | £2.99 | Shipped in packs of 50 |
| 1L dosage | 578 03 70-03 | £14.99 | £17.99 | Shipped in packs of 12 |
| 4 Litre | 578 03 71-03 | £54.16 | £64.99 | Shipped in packs of 3 |
| 10 Litre | 578 18 00-03 | £116.66 | £139.99 | - |
| 208 Litre | 578 18 04-03 | £2,499.17 | £2,999.00 | - |





4-STROKE OIL 10W-40



High quality engine oil for all 4-stroke garden equipment. Developed for easy starting at low temperatures, perfect lubrication at all operating conditions and low oil consumption.

| Volume | Order PNC | RRP ex VAT | RRP inc VAT | Dealer Information |
|-----------|--------------|------------|---------------|------------------------|
| 1.4 Litre | 577 41 97-02 | £10.83 | £12.99 | Shipped in packs of 12 |

4-STROKE 10W-30 TRANSMISSION OIL



Fully synthetic transmission oil that is specially developed for transmissions in Husqvarna ride-on machines. The fully synthetic transmission oil is extremely stable in both hot and cold temperatures.

| Volume | Order PNC | RRP ex VAT | RRP inc VAT | Dealer Information |
|---------|--------------|------------|---------------|-----------------------|
| 4 Litre | 597 68 70-04 | £41.66 | £49.99 | Shipped in packs of 3 |

4-STROKE SAE 30 ENGINE OIL



High-quality oil for 4-stroke lawn mowers. Gives the engine excellent protection.

| Volume | Order PNC | RRP ex VAT | RRP inc VAT | Dealer Information |
|-----------|--------------|------------|--------------|------------------------|
| 0.6 Litre | 577 41 92-01 | £4.16 | £4.99 | Shipped in packs of 12 |
| 1.4 Litre | 577 41 97-01 | £8.33 | £9.99 | Shipped in packs of 12 |

AIR FILTER OIL



Biodegradable. Effectively traps particles in the filter, keeping the engine cleaner and reducing wear.

| Volume | Order PNC | RRP ex VAT | RRP inc VAT | Dealer Information |
|---------|--------------|------------|---------------|------------------------|
| 1 Litre | 531 00 92-48 | £21.66 | £25.99 | Shipped in packs of 12 |

MINERAL CHAIN OIL



Mineral Chain oil with adhesive agent for high-performance chain saws. Guaranteed low wear of chains and rails. For universal use all year round.

| Volume | Order PNC | RRP ex VAT | RRP inc VAT | Dealer Information |
|-----------|--------------|------------|----------------|------------------------|
| 1 Litre | 579 39 60-01 | £4.16 | £4.99 | Shipped in packs of 12 |
| 5 Litre | 579 39 61-01 | £14.16 | £16.99 | Shipped in packs of 4 |
| 20 Litre | 579 39 62-01 | £52.49 | £62.99 | - |
| 200 Litre | 579 39 63-01 | £499.17 | £599.00 | - |

X-GUARD BIO CHAIN OIL



Improved formula Husqvarna chain oil with superior lubrication performance even in extreme conditions. Excellent anti-oxidation properties protect the bar and chain during storage.

| Volume | Order PNC | RRP ex VAT | RRP inc VAT | Dealer Information |
|-----------|--------------|------------|----------------|------------------------|
| 1 Litre | 596 45 73-01 | £4.58 | £5.49 | Shipped in packs of 12 |
| 5 Litre | 596 45 73-02 | £16.66 | £19.99 | Shipped in packs of 4 |
| 10 Litre | 596 45 73-03 | £30.83 | £36.99 | Shipped in single |
| 20 Litre | 596 45 73-04 | £62.49 | £74.99 | Shipped in Single |
| 200 Litre | 596 45 73-05 | £624.17 | £749.00 | Shipped in Single |

MULTI PURPOSE / ECO GREASE / GREASE GUN



Multi Purpose grease with good corrosion protection and load carrying capacity. Suitable for general greasing purposes. For brushcutter bevel gears. Eco grease lubricates the transmission and absorbs the axial forces. Environmentally compatible and biodegradable.

| Volume | Item | Order PNC | RRP ex VAT | RRP inc VAT |
|--------|----------------------|--------------|------------|---------------|
| 225g | Multi Purpose Grease | 502 51 27-01 | £4.99 | £5.99 |
| 100g | Eco Grease | 503 97 64-01 | £5.83 | £6.99 |
| 0.6L | Grease Gun | 595 01 17-01 | £9.16 | £10.99 |

COMBI CAN



Enables you to refuel quickly without splash effects and any waste. The two containers are designed to achieve an optimised fuel and chain oil ratio. Integrated tool box for frequently needed spare parts and filling equipment. Approved in accordance with UN recommendations. Read more on page 68.

| Item | Order PNC | RRP ex VAT | RRP inc VAT |
|-------------------------|--------------|------------|---------------|
| Combi Can 5 + 2.5 Litre | 580 75 42-01 | £33.33 | £39.99 |
| Fuel Spout | 586 11 04-01 | £14.16 | £16.99 |
| Oil Spout | 586 11 05-01 | £14.16 | £16.99 |
| Winter Oil Spout | 586 11 07-01 | £7.49 | £8.99 |



CHANGE CLOTHES. NOT WHO YOU ARE.

Show who you are, even if you're not doing any tough work. The Husqvarna Xplorer series is designed with that in mind. These leisure wear clothes and accessories will help you feel comfortable and express your workday confidence in your free time.





QUALITY CLOTHES FOR QUALITY TIME

Stay comfortable off the job – and be ready for whatever that precious time off can offer. With the Husqvarna Xplorer leisure collection, you'll be prepared for the very best outdoor experience, never compromising on comfort, fit – or style. The clothes and equipment are all made from high-quality materials and adapted to a fulfilling life in the great outdoors.

OUTDOOR TROUSERS



Size
44 for X Small
46 for Small
50 for Medium
54 for Large
58 for X Large
62 for XX Large

Comfortable and durable trousers for outdoor activity with 4-way stretch fabric on knees and rear. Reinforced fabric in exposed areas and pre-bent knees add comfort and mobility. Adjustable waist and legs. Mobile phone is protected by a padded pocket.

| Item | Order PNC | RRP ex VAT | RRP inc VAT |
|-------------------------------------|--------------|------------|----------------|
| Mens. Grey & Forest Green. S - XXL | 597 41 85-XX | £91.66 | £109.99 |
| Womens. Grey & Grape Purple. XS - L | 597 43 08-XX | £91.66 | £109.99 |

FLEECE JACKET



Size
42 for X Small
46 for Small
50 for Medium
54 for Large
58 for X Large
62 for XX Large

The fleece jacket is a cosy companion in all seasons. On cold, early spring or autumn days it becomes a nice middle layer, or a comfortable outer jacket. The jacket comes in both men's and women's sizes so you can find your optimal fit.

| Item | Order PNC | RRP ex VAT | RRP inc VAT |
|---------------------------|--------------|------------|---------------|
| Womens. steel grey. XS-L | 593 25 22-XX | £70.83 | £84.99 |
| Mens. granite grey. S-XXL | 593 25 23-XX | £70.83 | £84.99 |

SHELL JACKET



Size
42 for X Small **54 for Large**
46 for Small **58 for X Large**
50 for Medium **62 for XX Large**

A breathable and water resistant shell jacket waterproofing 10 000 mm water columns, with flexible 4-way stretch material, gives you the best possible comfort. Equipped with taped seams and smart features such as padded mobile pocket, hidden ventilation under sleeves for adjustable airflow, and hook and loop flap closure on the sleeves.

| Item | Order PNC | RRP ex VAT | RRP inc VAT |
|----------------------------|--------------|------------|----------------|
| Womens. grape purple. XS-L | 593 25 04-XX | £140.83 | £169.00 |
| Mens. forest green. S-XXL | 593 25 05-XX | £140.83 | £169.00 |

FLEECE VEST



Size
42 for X Small **54 for Large**
46 for Small **58 for X Large**
50 for Medium **62 for XX Large**

Have your arms free and still keep warm. The fleece vest is ideal for many outdoor activities such as cutting firewood or working in the garden. The knitted fleece material is comfortable and soft, and the vest comes in both men's and women's sizes for an optimal fit.

| Item | Order PNC | RRP ex VAT | RRP inc VAT |
|---------------------------|--------------|------------|---------------|
| Womens. steel grey. XS-L | 593 25 43-XX | £49.99 | £59.99 |
| Mens. granite grey. S-XXL | 593 25 44-XX | £49.99 | £59.99 |

HOODIE



Size
42 for X Small **54 for Large**
46 for Small **58 for X Large**
50 for Medium **62 for XX Large**

Unisex hoodie is made out of comfortable materials, and comes in the colour Lichen green for you to feel like one with nature. Three pockets and a raised neck make this very practical.

| Item | Order PNC | RRP ex VAT | RRP inc VAT |
|----------------------------|--------------|------------|---------------|
| Hoodie Unisex lichen green | 597 93 12-XX | £57.50 | £69.00 |

T-SHIRT BARK CAMO



Size
42 for X Small **54 for Large**
46 for Small **58 for X Large**
50 for Medium **62 for XX Large**

The long sleeve t-shirt is a perfect choice for when the weather is not to be reckoned with, and layering is key. The t-shirt comes in unisex sizes and is made in a dark green colour with our Husqvarna crown logo in the bark camo pattern. Great for every day tasks. Sizes XS-XXL.

| Item | Order PNC | RRP ex VAT | RRP inc VAT |
|---------------------------|--------------|------------|---------------|
| T-Shirt bark camo. XS-XXL | 593 25 31-XX | £20.83 | £24.99 |



T-SHIRT FOREST CAMO



Size
42 for X Small **54 for Large**
46 for Small **58 for X Large**
50 for Medium **62 for XX Large**

The short sleeve t-shirt comes in unisex sizes, and in our grey coloured print, forest camo. The t-shirt is ideal to wear underneath a sweater for more warmth, or on its own in warmer temperatures. Sizes XS-XXL.

| Item | Order PNC | RRP ex VAT | RRP inc VAT |
|----------------------|--------------|------------|---------------|
| Unisex, camo, XS-XXL | 593 25 24-XX | £14.99 | £17.99 |

NECK TUBE



The neck tube is specifically developed for that extra warmth and to stop wind from cooling you down during easier tasks in the forest, or for windy and colder days. Available in orange with our bark camo print with the Husqvarna logo.

| Item | Order PNC | RRP ex VAT | RRP inc VAT |
|-----------|--------------|------------|--------------|
| Neck tube | 593 25 76-01 | £3.33 | £3.99 |

BEANIE PIONEER SAW



The beanie comes in black with a blow out print of our pioneer saw in the front. It is made from breathable Coolmax air material.

| Item | Order PNC | RRP ex VAT | RRP inc VAT |
|--------------------|--------------|------------|---------------|
| Beanie pioneer saw | 593 25 37-01 | £10.83 | £12.99 |

CAP



This collection offers three cap styles: a vintage orange cap with adjustable hook-and-loop with a print of our pioneer saw, a granite grey canvas cap with adjustable leather band, and a vintage cap in bark camo pattern with a bleeding orange visor and adjustable leather band.

| Item | Order PNC | RRP ex VAT | RRP inc VAT |
|-------------------------------------|--------------|------------|---------------|
| Pioneer saw, orange | 593 25 39-01 | £14.16 | £16.99 |
| Granite leather patch, granite grey | 593 25 40-01 | £15.83 | £18.99 |
| Bark camo, forest green | 594 72 97-01 | £15.83 | £18.99 |

DUFFEL BAG, 70L



A durable 70L duffel bag made of tough materials and smart features for all purposes. The outer material – tarpaulin – keeps your contents dry and is easy to clean. The inside pocket in mesh makes organising easier, and for extra convenience shoulder straps and two organising bags are included.

| Item | Order PNC | RRP ex VAT | RRP inc VAT |
|-----------------|--------------|------------|---------------|
| Duffel bag, 70L | 593 25 83-01 | £62.49 | £74.99 |

TROLLEY BAG, 90L



Trolley bag, holding 90L, perfect for transporting all your necessities. U-shaped zipper on top makes packing and structure easier, while the moulded side and bottom make the bag stand upright without support. For extra convenience, organising bags are included, as well as an ID pocket for easy recognition.

| Item | Order PNC | RRP ex VAT | RRP inc VAT |
|------------------|--------------|------------|---------------|
| Trolley bag, 90L | 593 25 81-01 | £83.33 | £99.99 |





BACKPACK, 30L



A comfortable, high-quality backpack for all weathers made from durable TPU/ribstop material that keeps the inside dry and also makes the backpack easy to clean. Large compartments for items such as your laptop, water bottle and thermos, and a roll-up seal that can be closed in two ways to keep water out.

| Item | Order PNC | RRP ex VAT | RRP inc VAT |
|---------------|--------------|------------|---------------|
| Backpack, 30L | 593 25 82-01 | £49.99 | £59.99 |

WATER BOTTLE INSULATED 0,5L



Make sure you stay properly hydrated – but avoid using unnecessary disposable plastics. This stainless steel bottle features a reinforced, tight-fitting cap with a strap to easily attach the bottle to a carabiner or your backpack.

| Item | Order PNC | RRP ex VAT | RRP inc VAT |
|-----------------------------|--------------|------------|---------------|
| Water Bottle Insulated 0.5L | 597 41 81-01 | £14.99 | £17.99 |

INSULATED FOOD CAN WITH SPOON 0,6L



Fill up quickly with energy and serve lunch from this handy food can. Equipped with a foldable spoon in the lid. The lid stays tightly shut without leaking and the wide opening makes it easy to eat from, fill up and clean the thermos after use.

| Item | Order PNC | RRP ex VAT | RRP inc VAT |
|------------------------------------|--------------|------------|---------------|
| Insulated Food Can With Spoon 0.6L | 597 41 78-01 | £16.66 | £19.99 |

THERMOS BOTTLE INSULATED 0,75L



Take your favourite beverage to your favourite outdoor spot in this insulated, crush-proof stainless steel thermos.

| Item | Order PNC | RRP ex VAT | RRP inc VAT |
|--------------------------------|--------------|------------|---------------|
| Thermos Bottle Insulated 0.75L | 597 41 79-01 | £16.66 | £19.99 |





HUSQVARNA CLOTHING



Essential for any Husqvarna fan! There is something for any occasion in our extensive Husqvarna clothing collection, whether it be a cap, hoodie or a coat, why not express yourself by wearing something from our merchandise collection.

BASEBALL CAP



Navy cotton twill cap with white embroidered Husqvarna logo on the front and RWYA on the side, adjustable size. One size fits all.

| | |
|--------------|--------------|
| Order PNC | |
| 582 39 69-01 | |
| RRP ex VAT | RRP inc VAT |
| £2.49 | £2.99 |

BEANIE HAT



Navy with White 'Ready When You Are' print, label and orange stitching. 95% cotton/5% Lycra.

| | |
|--------------|--------------|
| Order PNC | |
| 582 39 20-01 | |
| RRP ex VAT | RRP inc VAT |
| £4.16 | £4.99 |

COTTON POLO SHIRT



| Mens | | Womens | |
|------|----------|--------|---------|
| 48 | Small | 46 | X Small |
| 50 | Medium | 48 | Small |
| 52 | Large | 50 | Medium |
| 54 | X Large | 52 | Large |
| 56 | XX Large | 54 | X Large |

100% cotton navy polo shirt with Husqvarna logo on chest and 'Ready When You Are' logo on sleeve.

| | | | |
|----------------------|--|------------|---------------|
| Order PNC | | RRP ex VAT | RRP inc VAT |
| Mens: 101 63 80-XX | | £20.83 | £24.99 |
| Womens: 101 63 79-XX | | £20.83 | £24.99 |

BUSINESS SHIRT



| Mens | |
|------|-----------|
| 01 | Small |
| 02 | Medium |
| 03 | Large |
| 04 | X Large |
| 05 | XX Large |
| 06 | XXX Large |

Regular fit white shirt. 100% cotton with Navy Husqvarna logo on cuff.

| | | | |
|--------------|--|------------|---------------|
| Order PNC | | RRP ex VAT | RRP inc VAT |
| 582 05 06-XX | | £58.33 | £69.99 |

BODYWARMER



| Mens | |
|------|-----------|
| 01 | Small |
| 02 | Medium |
| 03 | Large |
| 04 | X Large |
| 05 | XX Large |
| 06 | XXX Large |

Navy softshell bodywarmer with white embroidered Husqvarna logo and zipped chest pocket. Water/wind resistant.

| | | | |
|--------------|--|------------|---------------|
| Order PNC | | RRP ex VAT | RRP inc VAT |
| 582 36 57-XX | | £45.83 | £54.99 |





HOODIE



- Mens**
- 01 Small
 - 02 Medium
 - 03 Large
 - 04 X Large
 - 05 XX Large
 - 06 XXX Large

High quality sweat hoodie with Husqvarna logo on chest with chest pocket and 'Ready When You Are' text on sleeve. 92% cotton/ 8% Lycra.

| Order PNC | RRP ex VAT | RRP inc VAT |
|--------------|------------|---------------|
| 582 39 93-XX | £45.83 | £54.99 |

POWERFLEECE



- | Mens | Womens |
|-------------|------------|
| 01 Small | 01 X Small |
| 02 Medium | 02 Small |
| 03 Large | 03 Medium |
| 04 X Large | 04 Large |
| 05 XX Large | 05 X Large |

Navy zip up lightweight jacket with orange stitching on sleeves and white Husqvarna logo on chest. Available for men and women.

| Order PNC | RRP ex VAT | RRP inc VAT |
|----------------------|------------|---------------|
| Mens: 582 40 21-XX | £29.16 | £34.99 |
| Womens: 582 40 20-XX | £29.16 | £34.99 |

T-SHIRT



- Unisex**
- 01 Small
 - 02 Medium
 - 03 Large
 - 04 X Large
 - 05 XX Large

100% cotton, high quality unisex t-shirt.

| Order PNC | RRP ex VAT | RRP inc VAT |
|--------------|------------|--------------|
| 582 32 48-XX | £8.33 | £9.99 |

FUNCTIONAL JACKET



- | Mens | Womens |
|--------------|------------|
| 01 Small | 01 X Small |
| 02 Medium | 02 Small |
| 03 Large | 03 Medium |
| 04 X Large | 04 Large |
| 05 XX Large | 05 X Large |
| 06 XXX Large | |

Lightweight hooded jacket with Husqvarna logo, with zipped pocket on sleeve. Water/windproof, breathable fabric.

| Order PNC | RRP ex VAT | RRP inc VAT |
|----------------------|------------|---------------|
| Mens: 582 40 73-XX | £66.66 | £79.99 |
| Womens: 582 40 72-XX | £66.66 | £79.99 |

SPORT JACKET



- | Mens | Womens |
|--------------|------------|
| 01 Small | 01 X Small |
| 02 Medium | 02 Small |
| 03 Large | 03 Medium |
| 04 X Large | 04 Large |
| 05 XX Large | 05 X Large |
| 06 XXX Large | |

Light quilted jacket with soft polyester shell. Features white embroidered Husqvarna logo and chest pocket.

| Order PNC | RRP ex VAT | RRP inc VAT |
|----------------------|------------|---------------|
| Mens: 582 22 88-XX | £62.49 | £74.99 |
| Womens: 582 22 86-XX | £62.49 | £74.99 |

WINTER JACKET



- | Mens | Womens |
|--------------|------------|
| 01 Small | 01 X Small |
| 02 Medium | 02 Small |
| 03 Large | 03 Medium |
| 04 X Large | 04 Large |
| 05 XX Large | 05 X Large |
| 06 XXX Large | |

Light quilted jacket with padded fillings. Features chest pocket and white printed Husqvarna logo.

| Order PNC | RRP ex VAT | RRP inc VAT |
|----------------------|------------|---------------|
| Mens: 582 22 73-XX | £66.66 | £79.99 |
| Womens: 582 22 91-XX | £66.66 | £79.99 |





HUSQVARNA ACCESSORIES



Husqvarna accessories offer something for any Husqvarna fan from bags to keyrings and even tumblers. Any item from this page makes a great gift or stocking filler.

CHAINSAW KEYRING



Chainsaw keyring with bottle opener makes this the perfect companion.

| | |
|--------------|--------------|
| Order PNC | |
| 590 96 00-01 | |
| RRP ex VAT | RRP inc VAT |
| £3.33 | £3.99 |

CHAINSAW KEYCOVER



Rubber key cover with keyring, featuring push activated LED light.

| | |
|--------------|--------------|
| Order PNC | |
| 590 76 84-01 | |
| RRP ex VAT | RRP inc VAT |
| £1.66 | £1.99 |

Dealer information: PNC is for 1 x pack of 10. Please note, price is for single item

KEYRING



Metal keyring with leather strap. Featuring embossed logo and 'Ready When You Are' text.

| | |
|--------------|--------------|
| Order PNC | |
| 582 39 95-01 | |
| RRP ex VAT | RRP inc VAT |
| £1.66 | £1.99 |

BACKPACK



Navy backpack with embroidered logo detail and zipped front pocket.

| | |
|--------------|---------------|
| Order PNC | |
| 582 39 18-01 | |
| RRP ex VAT | RRP inc VAT |
| £16.66 | £19.99 |

SPORTS BAG



Navy spacious sports bag with embroidered logo and orange straps. 'Ready When You Are' logo also features.

| | |
|--------------|---------------|
| Order PNC | |
| 582 40 36-01 | |
| RRP ex VAT | RRP inc VAT |
| £20.83 | £24.99 |

GRANITY TUMBLER



Clear glass tumbler with Husqvarna logo - 31cl.

| | |
|--------------|--------------|
| Order PNC | |
| 590 21 06-01 | |
| RRP ex VAT | RRP inc VAT |
| £4.99 | £5.99 |

Dealer information: PNC is for 1 x pack of 12. Please note, price is for single item

CHRONO WATCH



High quality chronograph watch with Citizen movement. Comes with 5 years warranty, leather strap with stitching detail and giftbox.

| | |
|--------------|---------------|
| Order PNC | |
| 582 40 64-01 | |
| RRP ex VAT | RRP inc VAT |
| £49.99 | £59.99 |

SPORTS WATCH



With silicon rubber strap with Seiko movement. Comes with 3 years warranty.

| | |
|--------------|---------------|
| Order PNC | |
| 582 40 37-01 | |
| RRP ex VAT | RRP inc VAT |
| £14.99 | £17.99 |





THERMOS FLASK



Keep your drinks warmer for longer. Perfect for those who are outside all day.

| Item | Order PNC |
|------------|---------------|
| 0.5 Litre | 582 40 61-01 |
| 0.75 Litre | 582 40 61-02 |
| RRP ex VAT | RRP inc VAT |
| £8.33 | £9.99 |
| £11.66 | £13.99 |

TRAVEL FLASK



The perfect travel companion. Available in 0.35 Litre.

| Order PNC | |
|--------------|---------------|
| 582 40 62-01 | |
| RRP ex VAT | RRP inc VAT |
| £9.99 | £11.99 |

BALL POINT PEN



Basic ball point pen in blue ink.

| Order PNC | |
|--------------|--------------|
| 582 39 19-01 | |
| RRP ex VAT | RRP inc VAT |
| £0.33 | £0.39 |

Dealer information: Shipped in packs of 10

KNIGHT PEN



High quality metal pen in blue ink.

| Order PNC | |
|--------------|--------------|
| 522 02 62-01 | |
| RRP ex VAT | RRP inc VAT |
| £4.16 | £4.99 |

IPHONE CASES



Husqvarna branded phone case. Available for iPhone 6/6s and 7.

| Item | Order PNC |
|-------------|--------------|
| iPhone 6/6s | 588 13 79-01 |
| iPhone 7 | 588 13 79-02 |
| RRP ex VAT | RRP inc VAT |
| £3.33 | £3.99 |

AUTOMOWER® USB



8GB Husqvarna Automower® USB.

| Order PNC | |
|--------------|---------------|
| 580 71 44-01 | |
| RRP ex VAT | RRP inc VAT |
| £9.16 | £10.99 |

GOLF UMBRELLA



Stormproof golf umbrella with Husqvarna logo and 'Ready When You Are' text. 30" diameter and EVA handle for good grip.

| Order PNC | |
|--------------|---------------|
| 101 69 20-20 | |
| RRP ex VAT | RRP inc VAT |
| £12.49 | £14.99 |





HUSQVARNA WORD BY WORD

A

ACTIVE AIR FILTRATION™ One of the most efficient air filtration systems on the market. Longer service intervals and less engine wear – even in tough conditions.

ADJUSTABLE HANDLEBAR Wing nut operation adjusts handlebars both horizontally and vertically for optimum working position.

ADJUSTABLE OIL PUMP An adjustable oil pump provides the bar and chain the right amount of lubrication for every task.

ADJUSTABLE REAR HANDLE The rear handle is adjustable to facilitate cutting the sides and top of hedges.

ADJUSTABLE SLIDING SEAT Adjustable while seated; seat moves forward and down, or backwards and up.

ALL-WHEEL-DRIVE (AWD) Ensures traction on uneven, wet and slippery areas and slopes. AWD automatically adjusts the traction on all wheels depending on situation and ground condition.

ANTI-SCALP WHEELS AND FRONT ROLLER Most cutting decks are equipped with anti-scalp wheels and sometimes also a front roller. These reduce the risk of scalping when cutting uneven lawns.

AIR INDUCTION™ A powerful air stream lifts the grass before it is cut, for excellent cutting and collection of both grass and leaves.

AIR INJECTION™ Centrifugal air cleaning system for reduced wear and longer operating time between filter cleanings.

AIR PURGE Air Purge and a decompression valve make the machine extra easy to start.

ARTICULATED STEERING The unique articulated steering system allows the rear pair of wheels to swing in underneath the machine. The result is superior manoeuvrability with a minimum turning radius at full lock.

ATTACHMENT FRAME Easy to shift between cutting decks and front-mounted attachments, such as broom, flail mower, snow blade and snow thrower. No tools or belt changes needed.

AUTOMATIC PASSAGE HANDLING The robotic mower automatically senses narrow passages and will vary its route through the passage to avoid unpleasant tracks.

AUTO RETURN STOP SWITCH Stop switch automatically resets to the ON position for trouble-free starting.

AUTOTUNE™ Provides maximum power through automatic engine setting. No time spent on manual carburettor adjustment. Autotune™ compensates for different fuels, altitude, humidity and ambient temperature.

B

BALANCE HARNESS An ergonomic harness that distributes the load optimally between shoulders, chest and back. Wide padded straps and wide back plate reduce the load. Hip pad with travelling connection reduces body movement.

BALANCE X™ HARNESS A unique ergonomic harness that effectively spreads the machine's weight and maximises its excellent balance. The machine feels much lighter, and much easier and less strenuous to move around. Ergonomic harness with broad back support that distributes the load over a larger area. The hip belt has a shock-absorbing hip pad.

BALANCE XT™ HARNESS A harness providing excellent ergonomics. The load is spread on both shoulders, over the chest and the back and on the hips. This makes the machine feel much lighter, and less strenuous to move around. A wide adjustable back plate, which is ventilated and shaped to fit the curve of the back, allows the harness to fit different body sizes. Wide, padded hip belt. The shock-absorbing hip pad has a travelling connection which reduces body movement.

BALL-BEARING FRONT WHEELS Heavy duty ball-bearings provide long lasting and trouble free service on professional models.

BAR CUTTING LENGTH The cutting length is different from its overall length. It's the distance from the front of the saw to the tip of the farthest cutter rounded to the nearest inch / cm's.

BIOCLIP® (MULCHING) The grass is cut into small pieces that quickly decompose and return to the lawn as fertiliser, also making the lawn more drought resistant. BioClip® is suitable for frequently cut areas.

BIOCLIP® KIT / COVER Makes it possible to convert your side ejection tractor to BioClip®, which means that the grass is cut into small pieces that quickly decompose and return to the lawn as fertiliser, also making the lawn more drought resistant.

BLUETOOTH A standard for the short-range wireless interconnection of mobile phones, computers, and other electronic devices.

C

CARRYING HANDLE / S Facilitates lifting and transport.

CARGO HOLDER The practical carrier and compartment on the engine hood can be used for extra equipment.

CAST FRONT AXLE Heavy cast front axle provides superior balance and stability, even with a collector.

CENTRAL CUTTING HEIGHT ADJUSTMENT Quick and easy adjustment of grass cutting height with one lever.

CHOKeless START Easy to get operating with automatic choke. Just turn the key and go.

COLLECT BLADE Top class collection performance with minimum clippings left on the lawn, giving the lawn a tidy and nice look.

COLLECTION When collecting the grass you get a tidy cutting result. The risk of spreading weeds is less and the collected grass is easily emptied into a compost bin. You can also collect leaves and small twigs.

COMBI CUTTING DECK The Combi cutting deck offers the versatility of two different cutting systems. Choose between BioClip® for lawn fertilisation and rear ejection for efficient mowing on areas with higher and rougher grass.

COMBI-GUARD The same cutting equipment guard can be used when using trimmer head and grass blade.

COMBINED CHOKE/STOP CONTROL Combined choke/stop control allows for easier starting and reduces the risk of engine flooding.

COUNTERWEIGHT Increases weight on the wheels and improves balance.

CUP HOLDER Convenient cup holder for refreshments during operation.

CUTTING DECK TRANSPORT MODE The cutting deck can be folded back along the tube into a transport mode for easy transport and storage.

CUTTING HEIGHT INDICATOR A well-placed indicator window makes it easy to control the cutting height settings.

D

DETACHABLE SHAFT Detachable shaft for easy transport and storage.

DOUBLE BALL-BEARING WHEELS Ensure the mower rolls easily and without the wheels becoming loose, even after many years of use.

DOWN-DRAFTED VENTS The collector's down-drafted vents direct noise and dust downwards, away from the user, creating a more comfortable working environment.

DRIVEN WHEELS Powered wheels for easy and comfortable operation.

DUST BLOCKER COLLECTOR BAG Designed to keep dust into the bag, preventing it from blowing in the operators face.

E

EASY ADJUSTABLE HANDLE BAR Quick and easy adjustment of the handle in two different heights.

EASY ADJUSTABLE CUTTING HEIGHT A well balanced one hand grip on our lawnmowers makes adjustment of cutting height easy and convenient.

EASY-ADJUST BLADE GUARD The blade guard is adapted quickly and easily during operation.

ELECTRONICS Push button start, indicator lamps for parking brake, battery, headlights, ROS and blade engagement.

ELECTRIC ENGAGEMENT OF CUTTING BLADE / S Easy engagement of cutting blade /s; simply pull the switch on the control panel.

ENGINE BEHIND DRIVER Thanks to the rear-mounted engine, you get better overview of the mowing and less noise and emissions in the driver's area.

ERGONOMIC HANDLES Angled handlebar provide excellent grip to reduce unnecessary strain giving optimum comfort and ergonomic operating control.

ERGONOMIC STEERING WHEEL Ergonomic and comfortable steering wheel.

F

FAST TRANSMISSION For extra efficient mowing and fast transport speed.

FOLDABLE HANDLES Meets the need for easy storage and transporting.

FOUR EQUALLY-SIZED WHEELS Large wheels both front and back provide optimal riding comfort, great accessibility and less risk of damaging delicate surfaces.

FRONT-MOUNTED CUTTING DECK Front-mounted cutting deck for excellent accessibility into corners and under bushes, park benches etc.

FUEL PUMP Fuel pump designed for easy starting by reducing the number of pulls in the starter cord.

G

GPS COMMUNICATION UNIT GPS theft tracker. SMS alert. Settings changes can be handled from a distance as well as submitting current operating status.

GPS-ASSISTED NAVIGATION An onboard GPS system creates a map of the garden, including where the boundary and guide wires are installed.

H

HANDLE HEIGHT ADJUSTMENT Adjustable handle height for improved ergonomics.

HEADLIGHTS Makes the products more visible and allows you to work when it's dark.

HEATED CARBURETTOR A heated carburettor lets the engine start easier and run smoother in cold working environments.

HEATED HANDLES Efficient heating coils in the front and rear handles make operating in cold and damp conditions more manageable.

HIDDEN CABLES The cables are hidden inside the handle tubes, which eliminates the risk of them becoming tangled in hedges or damaged when the handle is folded.

HIGH-CAPACITY BATTERY The high-capacity battery provides performance levels comparable to a petrol driven machine.

HIGH OFFSET POST High offset post increases freedom of movement when working in slopes.

HOURLY METER Helps you having control over service and maintenance intervals.



HYDRAULIC EQUIPMENT LIFT Controls front-mounted equipment quick and with high precision. Managed by a easy reachable joy-stick placed on the control panel beside the operators seat.

HYDROSTATIC TRANSMISSION Optimises speed and provides excellent driving comfort. Speed and direction are controlled by separate pedals for forward and reverse.

HYDROSTATIC TRANSMISSION, FAST Hi-speed transmission for superior transport speeds and smooth, variable forward and reverse speeds with the aid of pedals.

I

INTEGRATED LOOP FOR ROPE A sturdy point for fastening a rope, making it easy to hoist the chainsaw up into a tree.

INERTIA-ACTIVATED CHAIN BRAKE If a kickback occurs and the tip of the bar is forced upwards, the inertia of the front guard should activate the chain brake instantly.

INTUITIVE KEY PAD Our battery products is very easy to operate, all information you need in one place.

L

LED HEADLIGHTS Gives over 50 % larger lit area compared to traditional incandescent lights.

LOW NOISE ENGINE Quiet operation provides a comfortable work situation and low disturbance for others.

LOW VIB® Effective anti-vibration dampeners absorb vibration, sparing the user's arms and hands.

M

MY AUTOMOWER® An iPhone application that makes it possible for you to control the robotic lawnmower with your mobile phone.

O

OIL COOLER A heat exchanger for cooling the hydraulic system. The cooling system is adequate to keep oil temperatures within safe limits.

OPTIONAL CUTTING DECK To ensure a perfect result, most of our Riders have different cutting decks as options.

ONE-PIECE CUTTING DECK The cutting deck comes in one piece straight out of the stamping line which means it has no welded parts. This gives very high torsional rigidity, tolerance and durability as well as sturdiness in operation.

P

PEDAL-OPERATED HYDROSTATIC TRANSMISSION Easy speed and direction control with pedal-operated hydrostatic transmission. Separate pedals for forward and reverse.

PIVOTING FRONT AXLE Ensures good balance and excellent driving comfort.

PIVOTING REAR AXLE The rear axle is pivoting to get maximum traction on the drive wheels and a smooth ride also on uneven surfaces.

POLY-V BELT For better power transmission, less frequent retensioning and increased product life.

POWER STEERING Steering effort is reduced by providing hydraulic pressure to assist when turning the wheels, making manoeuvring easier, more controlled and easier to operate.

PREMIUM SEAT Comfortable Premium seat with high back and armrests. The seat is self-draining and can be tipped to protect it from rain.

PRESSURE-LUBRICATED ENGINE An oil pump ensures that all vital parts in the engine get adequate lubrication.

Q

QUICK RELEASE ON AIR FILTER Makes it easy to remove the air filter for cleaning or replacement. No tools required.

QUICK RELEASE ON AIR FILTER COVER Makes it easy to access the air filter and spark plug quickly for cleaning or replacement. A valuable advantage, especially if the saw is used for long periods on a daily basis.

R

REAR IMPACT GUARD The rear-impact guard protects the pole saw engine from wear and damage.

REAR EJECTION These cutting systems have high capacity and are therefore suitable for taller grass, coarser grass types and seldom-cut lawns.

REINFORCED CUTTING DECK The steel tube on the edge of the cutting deck gives improved durability.

REMOTE CONTROLLED CUTTING DECK The remote control makes it easy to adjust the cutting deck angle during operation.

REMOTE TEXT MESSAGING If something unforeseen disturbs operation, this function allows the robotic mower to send a text message to a pre-programmed mobile phone

RETAINED BAR NUTS The bar nuts are attached to the clutch cover. The retaining function prevents losing the bar nuts.

S

SAVE™ Maximises runtime of our battery driven products.

SAFETY SWITCH The tractors are equipped with a safety switch under the seat. If the driver leaves the seat the engine and cutting deck are automatically switched off.

SEPARATE OIL FILTER A separate oil filter is easy to change to ensure that clean oil is circulated inside the engine.

SERVICE POINTS The tilting hood and easy-access servicing points make maintenance and servicing easy.

SERVICE POSITION Without tools you can quickly lift the cutting deck into the maintenance position, for convenient cleaning and service.

SIDE-MOUNTED CHAIN TENSIONER Side-mounted chain tensioner makes chain adjustment quick and easy.

SIDE PROTECTION BUMPER Additional protection when mowing next to wall edges or other obstacles.

SMART START® The engine and starter have been designed so the machine starts quickly with minimum effort and reduced resistance in the starter cord.

SMART START® DECOMPRESSION VALVE The engine and starter have been designed so the machine starts quickly with minimum effort.

SMART START® SPRING ASSISTED START When pulling the starter cord a special spring reduces the resistance in the starter cord.

SNR Signal To Noise Ratio is a measure that compares the level of a desired signal to the level of background noise.

SNAP-LOCK CYLINDER COVER Saves time when changing spark plugs and cleaning.

SOFT-GRIP HANDLE Reduces vibrations to reduce strain and add comfort for the user.

SOFTSTART™ Electronic SoftStart™ provides starting with normal, slow acting fuses.

STAND ALONE STARTER The stand alone starter makes it easier to change starter cord if needed. Easy to service and maintain.

STARTING REMINDER A decal placed on the top cover reminds you of the correct starting sequence for easy starts.

T

TAP-N-GO® Tap-n-Go® function for quick cord feed. Bump the trimmer head on the ground to feed new cord.

TOOL-LESS CHAIN TENSIONER Quick and easy chain tensioning and assembling of the bar and the chain without using any tools.

TOUCH-CONTROLS Comfortable operation with easy access touch controls for start, stop and reverse.

TRANSPARENT FUEL TANK Large, transparent fuel tank makes it easy to check the fuel level.

TWO-WAY ROTATION The trimmer head can rotate to the left or to the right. This means you avoid grass on walkways.

U

ULTRASONIC SENSOR Built-in sensors using ultrasonic technology help the mower to adjust the speed depending on the surroundings, and avoids hard collisions.

V

VARIABLE DRIVE SPEED Enables ground speed to be adjusted according to the needs and the conditions of the grass area where the work is taking place

VISIBLE FUEL LEVEL Makes it easy for the user to see when refill of fuel is needed.

VIBRATION-DAMPENED CARBURETTOR When vibration dampening the carburettor the engine runs smoother and with less need for adjustments.

W

WEATHER TIMER Adjusts the working time to the lawn's growth rate, meaning that the robotic mower will maximise or minimise its mowing time due to the weather.

X

XP® Premium professional chainsaws – packed with innovative design and technique for superb productivity.

X-CUT™ Researched and developed in-house. Our new family name of chains especially developed for our chainsaws, offering stay sharp technology, pre-stretched in the factory and increased efficiency.

X-FORCE® Researched and developed in-house. Our new family name of pro-laminated bars, offering more durability and lighter weight.

X-TORQ® Our patented, world-leading, 2-stroke X-Torq® technology gives you more power when you need it. But with less fuel consumption and less emissions, when compared to a standard 2-stroke engine. It's technology that works for you and the environment.

X-TRA EFFICIENCY The Rider X model features a car style engine hood with sound absorbing material for improved sound quality. This low sound technology makes it possible to increase the engine power and thereby also the blade and ground speed, which makes the X model extra efficient.

X-TRAC, HEAVY-TREAD TYRES For extra good traction.

OTHER

12 V OUTLET Makes it possible to plug in extra electric equipment, charge your cellular phone etc.



SUSTAINABLE GREEN SPACES THROUGH INNOVATION

Helping to shape green spaces and urban environments is at the core of our vision. By shifting to technologies that make our products as smart, efficient and optimised as possible – and by investing in sustainable innovations – we can make a real difference and contribute to positive change. Below you'll find some of our efforts within our various product categories.



ROBOTICS WITH A VISION: ZERO IMPACT

Husqvarna Automower® supports the transition from petrol-driven lawn mowers to silent and efficient lawn management in private gardens, commercial properties and public green spaces. Husqvarna Automower® robotic mowers have an extremely low noise level (down to only 58dB) and can replace ride-on and walk-behind mowers in residential areas, parks and green spaces as well as sports facilities, thereby reducing the carbon footprint and noise levels.

AUTOMOWER® 500 SERIES - PROUD TO BE MADE IN THE UNITED KINGDOM

Our most advanced range of robotic mowers, Automower® 500 Series are proudly made in the United Kingdom. Produced in a state of the art, sustainable factory that uses 100% green electricity with zero waste to landfill.

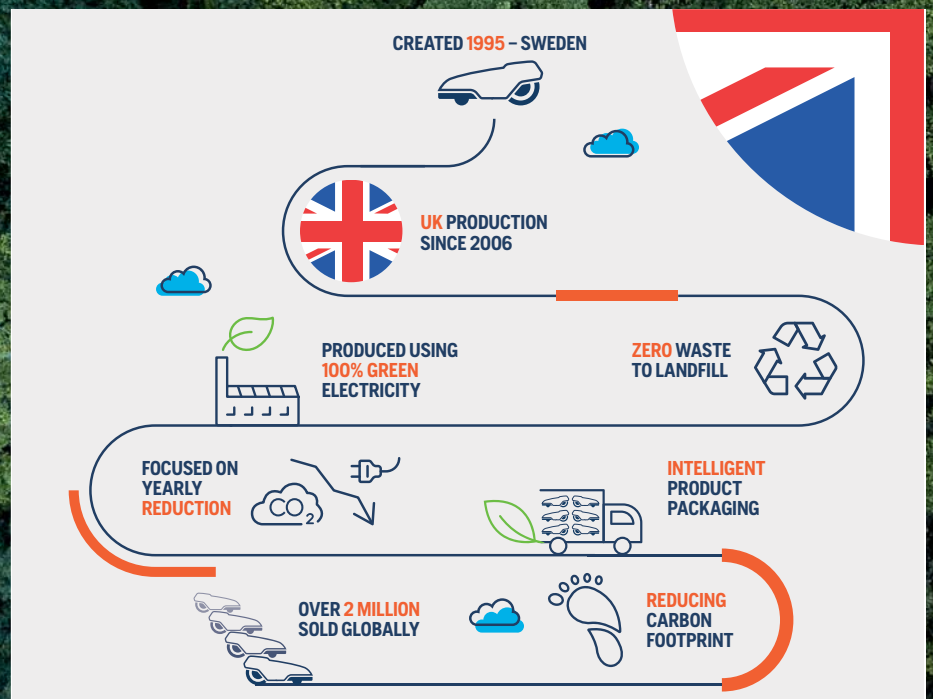

BATTERY RANGE TO CUT NOISE AND CARBON

Our wide range of low noise, battery-powered equipment delivers opportunities to use low-carbon energy sources and improves safety. Furthermore they spare the environment from fumes and the products have lower vibration and noise levels. Carbon emissions can be reduced to almost zero during use if the battery is charged with renewable energy.

CHAINSAW INNOVATIONS TO REDUCE EMISSIONS

Since 1990, we have reduced our chainsaws' fuel consumption by more than 30%. Our 70cc pro chainsaws have approximately 10% less CO₂ emissions compared to its predecessors thanks to innovations like the X-Torq® engine technology. And over the last 20 years, NOx + HC emissions have decreased by more than 50% for combustion engines.



For further advice and support:

rtmachinery.co.uk
LINKING VALUE WITH SERVICE

01844 299 037 | sales@rtmachinery.co.uk
RT Machinery Ltd, Brackwell Farm Estate, Winchendon Rd,
Nether Winchendon, Aylesbury, HP18 0DS, United Kingdom



Husqvarna

READY WHEN YOU ARE

Husqvarna UK Ltd, Preston Road, Aycliffe Business Park, Newton Aycliffe, County Durham, DL5 6UP.

Email: info@husqvarna.co.uk

Disclaimer Husqvarna UK Ltd reserve the right to change or modify any of their prices and product specifications without any prior notification. Copyright © 2021 Husqvarna AB (publ). All rights reserved. Husqvarna and other product and feature marks are trademarks of the Husqvarna Group as displayed at www.international.husqvarna.com