

Rapid

RAPID SINGLE-AXLE APPLIANCES

The Entire Product Range



Manufacturer's adress



Rapid Technic AG
 Industriestrasse 7
 8956 Killwangen
 Schweiz

Internet www.rapid.ch
 E-Mail info@rapid.ch
 Telefon 044 743 11 11

Opening hours for
 reception/ showroom:

Monday to Friday
 07:30 to 11:45
 13:15 to 17:00

How to find us

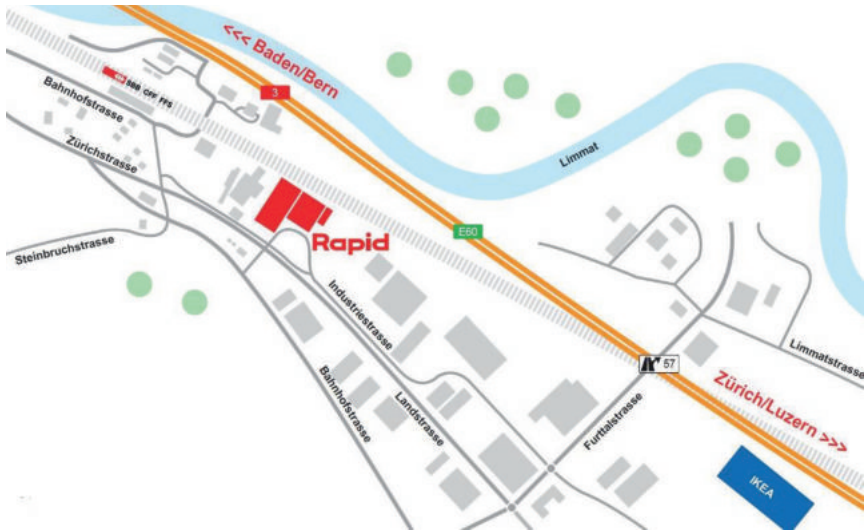

Notes:

CONTENTS

1.	BASIC APPLIANCES	P 5–30
1.1	RAPID REX.....	P 5
1.2	RAPID SWISS	P 9
1.3	RAPID MONDO.....	P 13
1.4	RAPID MONTA.....	P 17
1.5	RAPID VAREA	P 21
1.6	RAPID ORBITO	P 23
2.	MOWING TECHNOLOGY	P 31–42
3.	FORAGE HARVESTING	P 43–50
3.1	TWISTER HAYRAKE.....	P 43
3.2	MULTI-TWISTER.....	P 47
4.	MULCHING TECHNOLOGY	P 51–58
4.1	ECO-MULCHER	P 51
4.2	FLAIL MOWER	P 55
5.	TILLING	P 59–70
5.1	ROTARY TILLER.....	P 59
5.2	STONE BURIER.....	P 63
5.3	ROTARY HARROW.....	P 67
6.	WINTER SERVICES.....	P 71–78
6.1	SNOWPLOUGH BLADE.....	P 71
6.2	SNOW THROWER	P 75
7.	CLEANING.....	P 79–82
7.1	SWEEPERS	P 79
8.	SPECIAL APPLICATIONS.....	P 83–94
8.1	PATH MAINTENANCE UNIT	P 83
8.2	ROTARY WEED BRUSH.....	P 87
8.3	WEED BRUSH	P 91

Our core values ensure added value



Rapid machines are developed and manufactured in Switzerland. From design and production right through to assembly, quality assurance and our customer service and spare parts service, we embody the quality for which Switzerland is renowned day in, day out.



Operational safety is very important to us. That is why we use intelligent systems that combine safety with efficiency. Safety consciousness starts right back in the design phase so that when the machine is finally in the hands of the operator, safety is already built in. For us, that is par for the course.



All Rapid walk-behind tractors support continuously variable forward and reverse travel without any need for operating a clutch and shifting gears. Active steering systems ensure optimum handling even when travelling across very steep and challenging terrain. The operator simply uses the rotary grip to issue the desired commands and the machine then carries out the work precisely.



Rapid believes in sustainability and takes care of its natural and human resources accordingly. Whenever possible, we use environmentally friendly materials and work with modern and efficient production facilities. The result: high-quality products that are attuned to people and the environment.



The high performance and superb quality are what make our machines so efficient, whether they are used alone or in combination. And for isolated instances of use or many years of operation. Our core values involve making sure our products are durable and always ready for action.







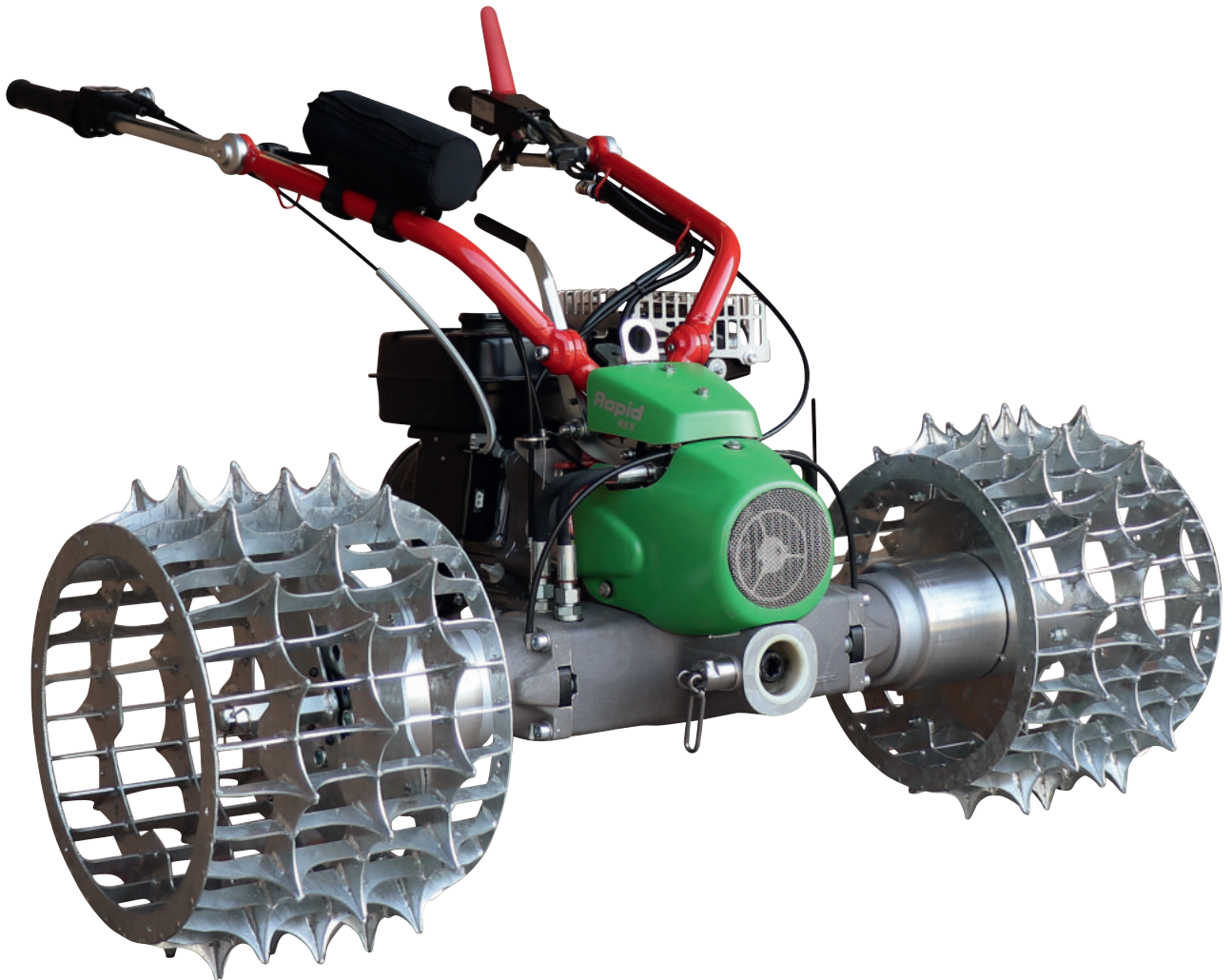

Each Rapid walk-behind tractor is suitable for a variety of applications throughout every season. Because they are multi-purpose, purchase and operating costs can be massively reduced. What's more, they take up less storage space than single-purpose machines. This means your money goes further but you still get to enjoy all the benefits.

Rapid

Rapid REX

unbelievably light and agile,
safe on the steepest of slopes

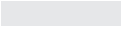

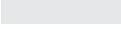
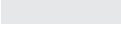
- Mowing technology 
- Forage harvesting 
- Mulching technology 
- Cleaning 
- Tilling 
- Winter services 
- Transport 
- Special applications 



Rapid REX – the world's lightest hydrostatic walk-behind tractor with active steering



With the Rapid Rex you can now carry out work that was once the preserve of scythes. Weighing just 85 kg and featuring a low centre of gravity, it can be used to tackle slopes with a gradient of up to 120% safely. The active handlebar steering means that it can be manoeuvred safely, precisely and with ease even on challenging terrain.



Technical specifications

Engine	Robin EX21
Type	4-stroke OHV petrol engine, air-cooled
Cubic capacity	211 cm ³
Cylinders	1
Max. power	7 HP/5.1 kW
Starter	Manual recoil starter
Weight	85 kg (without wheels)
Ability to handle slopes	Up to 120%
Travel drive	Hydrostatic, continuous speed adjustment forwards and in reverse
Speed	Forwards: 0–7 km/h, reverse: 0–4 km/h
Power take-off	645 rpm at an engine speed of 3600 rpm
Clutch	Electromagnetic clutch (engaged/disengaged)
Steering	Active hydraulic handlebar steering, can be deactivated
Connection flange	Tool-free quick change system Ø 52/54
Handlebar	Height-adjustable handlebar and handlebar ends
Immobilisation brake	Mechanical, acts on both wheels
Accessories	Climbing irons for shoes

The keys to success

- Carry out work safely on the steepest of slopes with a gradient of up to 120%
- Hydrostatic drive for continuously variable forward and reverse travel
- Active handlebar steering for easy and precise steering
- Maximum traction in any situation because both wheels are always driven
- Work without damaging the ground thanks to the low gross weight
- Different tyre types and combinations can be selected to suit the application concerned
- Includes climbing irons for shoes – so you can safely follow the Rapid Rex everywhere



Anton Oester, Adelboden

"Life on our alpine farm would now be totally unimaginable without the Rapid REX. I use it to mow steep slopes instead of doing it by hand, which used to be extremely laborious. The Rapid sprocket wheels provide optimum traction. This enables me to work safely while taking good care of the ground on steep slopes and in alpine meadows. This pays off in the long term by impacting positively on the natural environment. The performance of this compact machine is phenomenal."

Engine



Easy-start powerful petrol engine that represents the state of the art in terms of performance and emissions.

Accelerator lever

For setting the engine speed.



Rotary grip

Continuously variable forward or reverse travel without any need for clutch operation and gear shifting.



Power take-off control

The power take-off, which is mechanically coupled to the engine speed, can be easily switched on and off at the touch of a button.

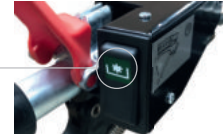

Handlebar end adjustment

Knurled screws allow you to adjust the handlebar ends quickly so that you can work safely and ergonomically on difficult terrain whatever the situation.

Steering locking lever

If necessary, this can be used to disable the active steering.

Handlebar steering

Apply lateral pressure to the handlebar to make the active steering respond. The drive wheels then rotate at different speeds so that precise steering manoeuvres can be carried out with ease. This saves wearing out the operator and is also good for the ground.



Immobilisation brake

The immobilisation brake acts mechanically on both wheels, thereby ensuring complete safety and peace of mind.



Dead man handle

If, for any reason, the operator lets go of the dead man handle, travel drive and device drive switch off immediately in the interest of safety; the combustion engine continues to run.



Jack ring

For safe lifting and fastening.

Quick change system

Allows you to change the various attachments in a flash and without any need for tools.



Handlebar height adjustment

Handlebar height can be adjusted precisely in accordance with the operator's needs.

Tyres

Flexible range of tyres and combination options tailored to your needs for optimum traction whatever the application.



Wheels and wheel combination examples



AS 4.00-8



Sprocket wheel, narrow

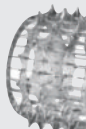

Sprocket wheel, wide

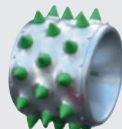

Sprocket roll, 3-row



Wheel combination



Wheel combination



Wheel combination



Wheel combination

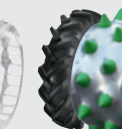

Wheel combination

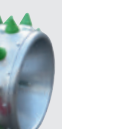

Wheel combination

Rapid REX Attachments



WALK-BEHIND TRACTOR MODEL		REX
Attachment name	Features	
Middle cut sickle bar 130, 145, 160 cm	Finger spacing 2"/50.8 mm, with outer shoe	•
Middle cut sickle bar 130, 145, 160 cm	Finger spacing 2"/50.8 mm, with side cutters	•
Normal cut sickle bar 130, 145, 160 cm	Finger spacing 3"/76,2 mm, with outer shoe	•
Normal cut sickle bar 130, 145, 160 cm	Finger spacing 3"/76,2 mm, with side cutters	•
Landscaping cutter bar 122, 142 cm	No fingers, no clogging, sprung/adjust. hold-down device	•
Twister hayrake 140	Working width 140 cm	•
Eco-Mulcher 70 cm	Continuously adjustable cutter height, driven on skids	•
Combi-Sweeper 90 cm	Universal brush Ø 35 cm	•
Dirt container 55, 65 l	For Combi-Sweeper 90, 110 cm	•
Side brush	Brush Ø 42 cm, for Combi-Sweepers	•
Snowplough 100 cm	Sprung, can be laterally adjusted from the handlebar	•

MOWING TECHNOLOGY
FORAGE HARVESTING
MULCHING TECHNOLOGY
CLEANING
TILLING
WINTER SERVICES
TRANSPORT
SPECIAL APPLICATION











Rapid

Rapid SWISS

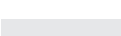
compact, powerful, agile and good on slopes

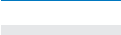

- Mowing technology 
- Forage harvesting 
- Mulching technology 
- Cleaning 
- Tilling 
- Winter services 
- Transport 
- Special applications 



Rapid SWISS – delighting users day after day on hilly and flat terrain with its compact design



The Rapid Swiss is a lightweight, compact and particularly agile walk-behind tractor. The continuously variable hydrostatic drive and active steering (which is controlled via the handlebar) make it easy to manoeuvre in even the most challenging of situations. The low centre of gravity and vast array of tyre options mean that the Rapid Swiss is a safe and efficient option, from flat to extremely steep locations.



Technical specifications

Engine	Robin EX 27
Type	4-stroke OHV petrol engine, air-cooled
Cubic capacity	265 cm ³
Cylinders	1
Max. power	9 HP/6.6 kW
Starter	Manual recoil starter
Weight	129 kg (incl. AS 4.00-10 tyres)
Ability to handle slopes	Up to 100%
Travel drive	Hydrostatic, continuous speed adjustment forwards and in reverse
Speed	Forwards: 0–7 km/h, reverse: 0–4 km/h
Power take-off	850 rpm at an engine speed of 3600 rpm
Clutch	Electro-magnetic clutch
Steering	Active hydraulic handlebar steering, can be deactivated
Free wheel change	Yes, can be towed
Connection flange	Tool-free quick change system Ø 78/80
Handlebar ends	Can be individually adjusted without tools
Immobilisation brake	Mechanical, acts on both wheels
Handlebar height adjustment	3 positions

The keys to success

- Can be steered with ease and precision even on steep terrain thanks to the active steering that is controlled via the handlebar
- The tried-and-tested Rapid rotary grip and hydrostatic drive enable continuously variable forward and reverse travel
- Optimum slope performance thanks to the low centre of gravity and the fact that the engines are fitted with a petrol pump as standard
- Ability to change to free-wheel mode easily and without any need for tools to facilitate manoeuvring and towing
- Tyre types can be combined to suit any application
- The low weight makes it an impressive product within its power class



Heidi Jucker-Schwegler, Office of Landscape, Agriculture and the Environment, Pfäffikon

"To keep our fantastic landscape looking great, I spend several hours a day caring for it with the Rapid Swiss. Mowing with the agile walk-behind tractor is highly efficient and really good fun because the hydrostatic machine with active steering is so easy to use. Even when performing turning manoeuvres on difficult terrain, I always feel perfectly safe with the Rapid Swiss."

Handlebar steering

Apply lateral pressure to the handlebar to make the active steering respond. The drive wheels then rotate at different speeds so that precise steering manoeuvres can be carried out with ease. This saves wearing out the operator and is also good for the ground.



Accelerator lever

For setting the engine speed.



Rotary grip

Continuously variable forward or reverse travel without any need for clutch operation and gear shifting.



Dead man handle

If, for any reason, the operator lets go of the dead man handle, travel drive and device drive switch off immediately in the interest of safety; the combustion engine continues to run.



Steering locking lever

If necessary, this can be used to disable the active steering.

Immobilisation brake

The immobilisation brake acts mechanically on both wheels, thereby ensuring complete safety and peace of mind.

Jack ring

For safe lifting and fastening.

Storage area

The optionally tool compartment is big enough to hold everything you need for daily maintenance.

Handlebar height adjustment

Handlebar height can be adjusted precisely in accordance with the operator's needs.

Quick change system

Allows you to change the various attachments in a flash and without any need for tools.

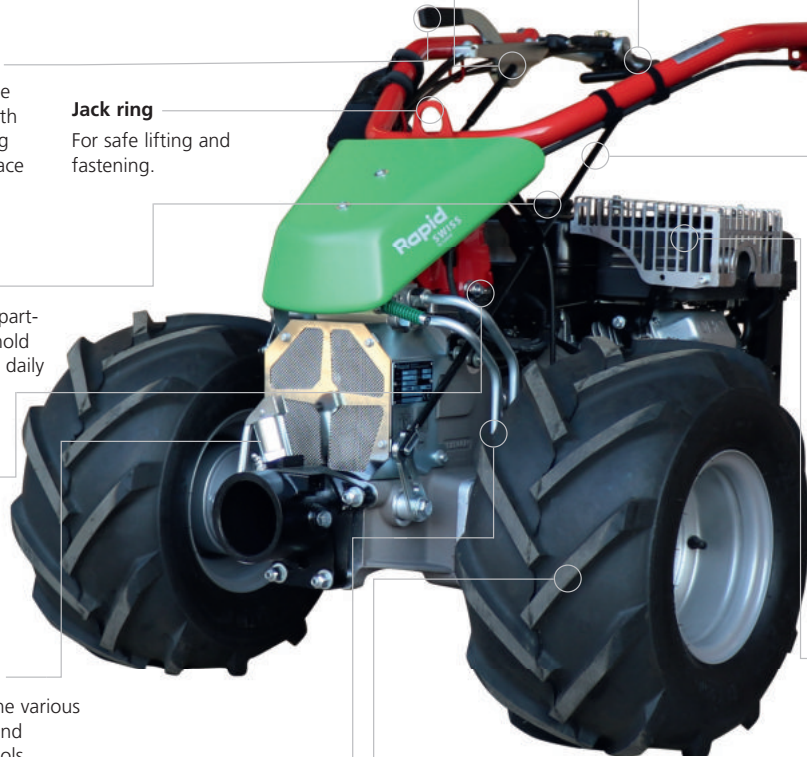

Clutch pushbutton

Actuation of the electromagnetic clutch by pressing the button for switching the device drive and the PTO drive on and off.

Handlebar end adjustment

Knurled screws allow you to adjust the handlebar ends quickly and without tools so that you can work safely and ergonomically on difficult terrain whatever the situation.

Power take-off control

The power take-off, which is mechanically coupled to the motor speed, can be easily switched on and off via the hand lever.

Engine

Easy-start powerful petrol engine that represents the state of the art in terms of performance and emissions.



Free wheel change

Allows you to manoeuvre and tow the machine without starting up the engine.

Tyres

Flexible range of tyres and combination options tailored to your needs for optimum traction according to the specific application.

Wheels and wheel combination examples



AS 4.00-10



RB 4.00-10

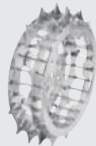

Sprocket wheel, narrow

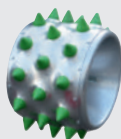

Sprocket roll, 3-row



Wheel combination



Wheel combination



Wheel combination



RB 18x7.00-8



BR 18x9.50-8

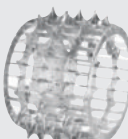

Sprocket wheel, wide



Wheel combination



Wheel combination

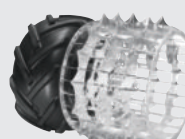

Wheel combination

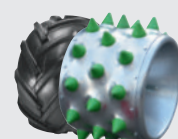

Wheel combination



WALK-BEHIND TRACTOR MODEL SWISS

Attachment name	Features	
Mulch sickle mower 105 cm	Cutter height 40–70 mm, incl. mulching device	•
Middle cut sickle bar 130, 145, 160, 190 cm	Finger spacing 2"/50.8 mm, with outer shoe	•
Middle cut sickle bar 130, 145, 160, 190 cm	Finger spacing 2"/50.8 mm, with side cutters	•
Normal cut sickle bar 130, 145, 160, 190 cm	Finger spacing 3"/76,2 mm, with outer shoe	•
Normal cut sickle bar 130, 145, 160, 190 cm	Finger spacing 3"/76,2 mm, with side cutters	•
Landscaping cutter bar 122, 142, 162 cm	No fingers, no clogging, sprung/adjust. hold-down device	•
Dual cutter bars 132, 146, 181 cm	Bidux system, blade spacing 70/70 mm, does not clog up	•
Bale wrapper	Incl. roll of foil	•
Twister hayrake 180	Working width 180 cm	•
Flail Mower 70 cm	Cutter height 20–100 mm, Y blades	•
Eco-Mulcher 80 cm	Continuously adjustable cutter height, driven on skids	•
Combi-Sweeper 110 cm	Universal brush Ø 35 cm	•
Dirt container 55, 65 l	For Combi-Sweeper 90, 110 cm	•
Side brush	Brush Ø 42 cm, for Combi-Sweepers	•
Snowplough 100/125 cm	Sprung, can be laterally adjusted from the handlebar	•
Combi-Snowplough 125 cm	Can be used as a wedge-shaped or V-shaped plough	•
Snow thrower 70 cm	Ejection chamber and gate adjustable from the handlebar	•
Combi-spreader	For sand, salt, grit, etc.	•
Path maintenance unit 90 cm	for water-bound surfaces	•
Weed brush WKB 60	Kersten	•

MOWING TECHNOLOGY
FORAGE HARVESTING
MULCHING TECHNOLOGY
CLEANING
TILLING
WINTER SERVICES
TRANSPORT
SPECIAL APPLICATION











Rapid

Rapid MONDO

the compact and versatile professional for urban and rural landscapes



- Mowing technology 
- Forage harvesting 
- Mulching technology 
- Cleaning 
- Tilling 
- Winter services 
- Transport 
- Special applications 



Rapid MONDO – the straightforward, compact, universal and highly flexible walk-behind tractor



The Rapid Mondo will delight horticulturists, the local authorities, farmers and caretakers alike. The extensive range of attachments make it extremely versatile. Depending on the attachment, you can swivel the Rapid Mondo handlebar or turn it right round to the other side. As with the handlebar height adjustment feature, this can be done completely without tools. Thanks to the Rapid Wendematic®, the operating functions always remain the same.



Technical specifications

Engine	Robin EX 27
Type	4-stroke OHV petrol engine, air-cooled
Cubic capacity	265 cm ³
Cylinders	1
Max. power	9 HP/6.6 kW
Starter	Manual recoil starter, optionally available with electric starter
Weight	125 kg (without wheels)
Ability to handle slopes	Up to 100%
Travel drive	Hydrostatic, continuous speed adjustment forwards and in reverse
Speed	Forwards: 0–6 km/h, reverse: 0–4 km/h
Power take-off	900 rpm at an engine speed of 3600 rpm
Clutch	Electromagnetic clutch (engaged/disengaged)
Differential	Mechanical lock
Free wheel change	Yes, manoeuvrable (cannot be towed)
Connection flange	Tool-free quick change system Ø 52/54
Handlebar	Can be swivelled without tools (230°), can be locked in 6 positions, height-adjustable without tools (9 positions), cushioned against vibrations, with Wendematic®
Immobilisation brake	Mechanical



The keys to success

- The rotary handlebar means work can be carried out with attachments mounted behind or in front of the axle
- The tried-and-tested Rapid rotary grip and hydrostatic drive support continuously variable forward and reverse travel without any need for clutch operation and gear shifting
- User-friendly differential lock
- Diverse range of attachments available
- The right tyres can be selected for any application

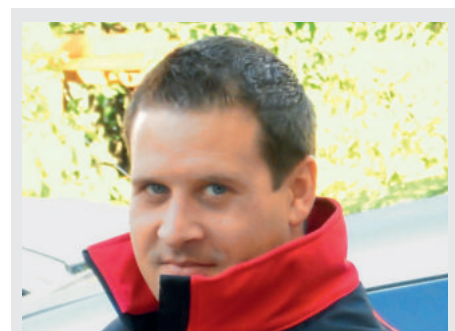

Rafael Schulte, trading partner, Vienna

"More than 1350 Rapid Mondo units are already being used in Vienna for everyday property maintenance tasks. Above all, they are prized for their versatility, easy handling and high quality. A Vienna without the Rapid Mondo would now be totally unimaginable."

Swivel and laterally adjust the handlebar

Using the hand lever, you can swivel the handlebar by 230° and lock it in six positions. Thanks to the Rapid Wendematic®, the operating elements continue to work in exactly the same way.



Power take-off control

The power take-off, which is mechanically coupled to the engine speed, can be easily switched on and off at the touch of a button.



Accelerator lever

For setting the engine speed.

Rotary grip

Continuously variable forward or reverse travel without any need for clutch operation and gear shifting.



Dead man handle

Pressing the dead man handle disengages the mechanical brake on the axle, thereby allowing the machine to start. If the dead man handle is released during operation, the PTO shaft and travel drive switch off immediately. At the same time, the brake stops the machine instantaneously.



Differential lock

To increase the traction, the differential can be locked if necessary.

Handlebar height adjustment

Handlebar height can be adjusted precisely in accordance with the operator's needs without any need for tools.



Additional weights

Optional additional weights for improved traction or to counterbalance heavy attachments. The weights are easy to mount or remove by hand.

Quick change system

Allows you to change the various attachments in a flash and without any need for tools.



Engine

Easy-start powerful petrol engine that represents the state-of-the-art in terms of efficiency and emissions.



Tyres

Flexible range of tyres and combination options tailored to your needs for optimum traction according to the specific application.

Hydraulic activation

Allows you to manoeuvre the machine without starting up the engine.

Wheels and wheel combination examples



AS 4.00-10



AS 5.00-10



RB 18x7.00-8



Wheel combination



Wheel combination

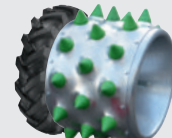

Wheel combination



RB 4.00-10



RB 20x8.00-10



BR 18x9.50-8



Wheel combination



Wheel combination

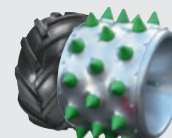

Wheel combination

Rapid MONDO Attachments



WALK-BEHIND TRACTOR MODEL		MONDO
Attachment name	Features	
Middle cut sickle bar 130, 145, 160 cm	Finger spacing 2"/50.8 mm, with outer shoe	•
Middle cut sickle bar 130, 145, 160 cm	Finger spacing 2"/50.8 mm, with side cutters	•
Landscaping cutter bar 122, 142, 162 cm	No fingers, no clogging, sprung/adjust. hold-down device	•
Dual cutter bars 132, 146 cm	Bidux system, blade spacing 70/70 mm, does not clog up	•
Sickle mower 105 cm	Cutter height 40-70 cm	•
Hayrake	Working width 125 cm, total width 180 cm	•
Eco-Mulcher 80 cm	Continuous height adjustment, driven on skids	•
Flail Mower 68 cm	Cutter height 10-100 mm, Y blades	•
Combi-Sweeper 90, 110 cm	Universal brush Ø 35 cm	•
Dirt container 55, 65 l	For Combi-Sweeper 90, 110 cm	•
Side brush	Brush Ø 42 cm, for Combi-Sweepers	•
Rotary tiller 70 cm	Rotary tilling direction can be adjusted	•
Stone burier 70 cm	Lateral drive, tilling depth 12 cm	•
Uni-Rotary Harrow 75 cm	Adjustable working depth	•
Snowplough 100/125 cm	Sprung, can be swivelled sideways from the handlebar	•
Combi-Snowplough 125 cm	Can be used as a wedge-shaped or V-shaped plough	•
Snow thrower 70 cm	Ejection chamber and gate adjustable from the handlebar	•
Combi-spreader	For sand, salt, grit, etc.	•
Mini Cargo	Transport trough can be tipped forwards	•
Trailer	Immobilisation brake, manual tipping device	•
Drilling container 37 l	For mounting on the 75 cm Uni-Rotary Harrow	•
Path maintenance unit 90 cm	for water-bound surfaces	•
Weed brush WKB 60	Kersten	•







MOWING TECHNOLOGY	FORAGE HARVESTING	MULCHING TECHNOLOGY	CLEANING	TILLING	WINTER SERVICES	TRANSPORT	SPECIAL APPLICATION
-------------------	-------------------	---------------------	----------	---------	-----------------	-----------	---------------------

Rapid

Rapid MONTA

Powerful mower for
extreme hillsides

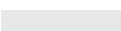

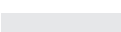
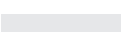
- Mowing technology 
- Forage harvesting 
- Mulching technology 
- Cleaning 
- Tilling 
- Winter services 
- Transport 
- Special applications 



Rapid MONTA – An uncompromising, powerful mower for high acreage performance and safe working on extreme hillsides



The compact Rapid MONTA is designed for high mowing acreage performance on hillsides. A low machine centre of gravity, the high bar bearing weight achieved by the axle position, and the new Rapid Soft handlebar bearing allow labour-saving and efficient work even over long operating times.

Technical data

Model designation	MONTA M141	MONTA S141	MONTA M161	MONTA S161
Engine	Robin EX40		Briggs & Stratton	
Type	4-stroke OHV petrol engine, air-cooled			
Cubic capacity	404 ccm		480 ccm	
Cylinders	1		2	
Max. power	14 PS / 10,3 kW		16 PS / 11, 8 kW	
Starter	Recoil starter			
Weight	179 kg (without wheels)	187 kg (without wheels)	188 kg (without wheels)	196 kg (without wheels)
Travel drive and steering actuation	Mechanical	Sensor-based	Mechanical	Sensor-based
Ability to handle slopes	Up to 120%		bis 100%	
Travel drive	Hydrostatic, continuously variable			
Travel drive clutch	Electro-magnetic clutch			
Speed	Forwards: 8 km/h, reverse: 4 km/h			
Power take-off	1000 rpm at an engine speed of 3600 rpm			
PTO shaft clutch	Electro-magnetic clutch			
Steering	Active handlebar or hand lever steering, switchable, with zero-turn function			
Freewheeling selection	Mechanical free wheel, towable			
Connection flange	tool-free quick change system \varnothing 78/80			
Handlebar	Adjustable to 11 different height settings without tools			
Handlebar lateral adjustment	Can be swivelled to the side without tools, lockable in 3 positions (0 and \pm 22°)			
Handlebar ends	Individual height adjustment without tools			
Immobilisation brake	Mechanical, acts on both wheels			

Success factors

- Continuously variable travel drive, no need for clutch operation and gear shifting
- Active hand lever or handlebar steering, switchable, for effortless and precise work
- Zero-turn function for soil-conserving turning manoeuvres in a confined space
- Tool-free attachment quick-change system
- Low centre of gravity and wide track ensure high overturning stability
- A housing geometry specially designed for mountain mowing offers a high bar bearing weight without additional

Model M and S



The models differ through their mechanical and sensor-based control of the pumps. The forces necessary for turning the rotary grip are lower for the S models; it is also possible to influence the driving behaviour by the control program.

Cockpit: M models



Cockpit: S models¹

¹ Only applies to the Rapid Monta S



Accelerator lever

For setting the motor speed.

Second dead man handle¹

The second dead man function is integrated in the rotary grip, allowing one-handed operation temporarily.

Immobilisation brake

The immobilisation brake acts mechanically on both wheels, ensuring complete safety and peace of mind.



Handlebar end adjustment

Knurled screws allow you to adjust the handlebar ends quickly and without tools so that you can work safely and ergonomically on difficult terrain whatever the situation.

Handlebar and hand lever steering

Depending on the working situation, you can choose to carry out steering manoeuvres precisely and easily using handlebar or hand lever steering.

Engine

Easy-start powerful petrol engine that represents the state of the art in terms of performance and emissions.

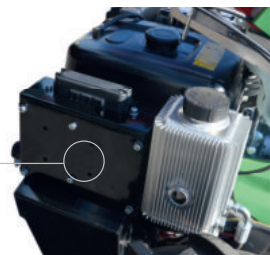

Controller¹

The controller is protected by the battery compartment.



Power take-off control

The power take-off, which is mechanically coupled to the engine speed, can be easily switched on and off at the touch of a button.

Quick change system

Allows you to change the various attachments in a flash and without any need for tools.



Jack ring

For safe lifting and fastening.

Zero-turn steering

Wheels that turn in opposite directions allow soil-conserving turning manoeuvres in the tightest of spaces.

Tyres

Flexible range of wheels and combination options tailored to your needs for optimum traction according to the specific application.

Free wheeling selection

Allows you to manoeuvre and tow the machine without starting up the engine.

Wheels and wheel combination examples



AS 5.00-10



Wheel combination

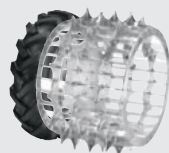

Wheel combination



BR 21x11.00-10

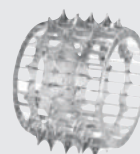

Sprocket wheel, wide

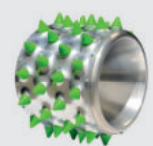

Sprocket roll, 4-row

Rapid MONTA Attachments



WALK-BEHIND TRACTOR MODEL		MONTA	MONTA	MONTA	MONTA
Attachment name	Features	M141	S141	M161	S161
Middle cut sickle bar 130, 145, 160, 190, 220, 250 cm	Finger spacing 2"/50.8 mm, with outer shoe or side cutting mechanism	•	•	•	•
Middle cut sickle bar 280 cm	Finger spacing 2"/50.8 mm, with side cutting mechanism	-	-	•	•
Normal cut sickle bar 130, 145, 160, 190, 220, 250 cm	Finger spacing 3"/76.2 mm, with outer shoe or side cutting mechanism	•	•	•	•
Normal cut sickle bar 280 cm	Finger spacing 3"/76.2 mm, with side cutting mechanism	-	-	•	•
Landscaping cutter bar 122, 142, 162 cm	No fingers, no clogging, sprung/adjustable hold-down device	-	-	•	•
Diamant cut sickle bar 174, 197, 220 cm	Finger spacing 58 mm, with outer shoe	•	•	•	•
Diamant cut sickle bar 174, 197, 220, 244 cm	Finger spacing 58 mm, with side cutters	•	•	•	•
Dual cutter bar 132, 146, 181, 204 cm	Bidux system, incl. skid weights	•	•	•	•
Broad gauge mower 160 cm	Bidux dual cutter bar system, does not clog up	•	•	•	•
Broad gauge mower 200 cm	Bidux dual cutter bar system, does not clog up	•	•	•	•
Broad gauge mower 230 cm	Bidux dual cutter bar system, does not clog up	-	-	•	•
Twister hayrake 180, 220 cm	Lateral downward forage conveying	•	•	•	•
Compact zero grazer 203, 206 cm	Finger spacing 2"/50.8 mm or 58 mm	•	•	•	•
Multi-Twister 190 cm	Active lateral forage conveying at both sides	-	-	•	•
Multi-Twister 220 cm	Active lateral forage conveying at both sides	-	-	•	•
Eco-Mulcher 80 cm	Continuous height adjustment, driven on skids	•	•	•	•
Flail mulcher 90 cm	Cutting height 20 – 100 mm, Y-blade	•	•	•	•
Flail mulcher 110 cm	Cutting height 20 – 100 mm, Y-blade	-	-	•	•
Combi-Sweeper 110 cm	Universal brush ø 42 cm	•	•	•	•
Snowplough 125 cm	Sprung, can be swivelled sideways from the handlebar	•	•	•	•
Snowplough 150 cm	Sprung, can be swivelled sideways from the handlebar	-	-	•	•

MOWING TECHNOLOGY	FORAGE HARVESTING	MULCHING TECHNOLOGY	CLEANING	TILLING	WINTER SERVICES	TRANSPORT	SPECIAL APPLICATIONS
-------------------	-------------------	---------------------	----------	---------	-----------------	-----------	----------------------



Handlebar lateral adjustment

With all models, the handlebar can be adjusted laterally without the need for tools. This makes it easy to work alongside obstacles or under bushes.



Rapid Soft handlebar bearing









The revolutionary Rapid Soft handlebar bearing, which is decoupled from the walk-behind tractor unit, reduces vibrations and oscillations to an incomparable degree and offers maximum ease of use especially with oscillating attachments.

Rapid

Rapid VAREA

Multi-functional all-rounder
for all four seasons

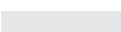

- Mowing technology 
- Forage harvesting 
- Mulching technology 
- Cleaning 
- Tilling 
- Winter services 
- Transport 
- Special applications 



Rapid VAREA – compact, easy to operate single-axle walk-behind tractor for local authorities, green/paved area maintenance, agriculture, gardening and landscaping.

The powerful Rapid VAREA is designed for varying types of work. Thanks to the handlebar which can be swivelled and rotated to the side, work is even easy to carry out around obstacles. The Rapid Soft handlebar bearing provides the operator with maximum comfort and therefore also non-tiring and light work, even for long periods.

NEW!

NEW!

Technical data	VAREA M141	VAREA S141	VAREA M161	VAREA S161	VAREA M231	VAREA S231
Engine	Subaru Robin EX40		Briggs & Stratton			
Type	4-stroke OHV petrol engine, air-cooled					
Cubic capacity	404 ccm		480 ccm		627 ccm	
Cylinders	1		2		2	
Max. power	14 HP / 10.3 kW		16 HP / 11.8 kW		23 HP / 16.9 kW	
Starter	Recoil starter					
Weight	180 kg (without wheels)	188 kg (without wheels)	189 kg (without wheels)	197 kg (without wheels)	205 kg (without wheels)	214 kg (without wheels)
Travel drive and steering actuation	Mechanical	Sensor-based	Mechanical	Sensor-based	Mechanical	Sensor-based
Ability to handle slopes	Up to 100%					
Travel drive	Hydrostatic, continuously variable					
Travel drive clutch	Electro-magnetic clutch					
Speed	Forwards: 8 km/h, reverse: 4 km/h					
Power take-off	1000 rpm at an engine speed of 3600 rpm					
PTO shaft clutch	Electro-magnetic clutch					
Steering	Active handlebar or hand lever steering, switchable, with zero-turn function					
Freewheeling selection	Mechanical free wheel, towable					
Connection flange	tool-free quick change system \varnothing 78/80					
Handlebar	Adjustable to 11 different height settings without tools					
Handlebar lateral adjustment/rotation	can be swivelled to the side without tools (0 and \pm 22°), lockable in 3 positions	can be swivelled to the side without tools and rotated by 232°, lockable in 6 positions	can be swivelled to the side and rotated (0 and \pm 22°), lockable in 3 positions	can be swivelled to the side without tools and rotated by 232°, lockable in 6 positions	can be swivelled to the side without tools (0 and \pm 22°), lockable in 3 positions	can be swivelled to the side without tools and rotated by 232°, lockable in 6 positions
Handlebar ends	Individual height adjustment without tools					
Immobilisation brake	Mechanical, acts on both wheels					

Model M and S



The models differ through their mechanical and sensor-based control of the pumps. The forces necessary for turning the rotary grip are lower for the S models; it is also possible to influence the driving behaviour by the control program.

Success factors

- Continuously variable travel drive, no need for clutch operation and gear shifting
- Active hand lever or handlebar steering, switchable, for effortless and precise work
- Zero-turn function for soil-conserving turning manoeuvres in a confined space
- Optimised device balance for effortless working with heavy attachments
- Applications with narrow attachments possible through narrow flange dimensions

Overview of models VAREA M141, S141, M161 and S161

The basic machines are suitable for miscellaneous applications in the local authority sector, green/paved area maintenance, gardening and landscaping.

The walk-behind tractors mainly stand out because of their narrower track width for narrower attachments and a centrally positioned axle that makes it easier to lift out heavy attachments. Models M141 and S141 and also VAREA M161 and S161 differ in terms of the power of the combustion engine and also the mechanical or sensor-based actuation.

VAREA M141 and M161

Success factors

- Tried and tested operating elements with mechanical actuation (wire cable)
- Swivel handlebar for operation next to obstacles



VAREA S141 and S161



Success factors

- Low forces on the operating elements through electronic actuation (sensors)
- Reaction behaviour can be changed (calibration process)
- Swivelling and rotating handlebar for easier coupling processes and applications
- Rotary grip remains in set position during forwards travel
- No reverse direction for hand lever steering during return trip

Overview of models VAREA M231 and S231

The Rapid VAREA, which is equipped with a 23 HP engine, is ideal for applications in local authority and public sectors, agriculture, gardening and landscaping.

Features such as handlebar lateral adjustment/rotation as well as switchable active hand lever or handlebar steering have been installed in the Rapid VAREA 231 as standard.

VAREA M231



VAREA S231



Success factors

- Work is made easy and comfortable due to an independent, switchable electromagnetic clutch for the PTO shaft drive
- Low level of vibration and oscillation for the operator thanks to the Rapid Soft handlebar bearing
- Tool-free quick change system for attachments
- Height adjustment of the handlebar and the handlebar ends for individual settings and ergonomic working
- Good motorisation for power-intensive work
- Wide range of attachments for universal and year-round use

Cockpit: S models¹

¹ Only applies to the Rapid Varea S

Second dead man handle

The second dead man function is integrated in the rotary grip, allowing one-handed operation temporarily.



Rotary grip

Continuously variable forward or reverse travel without any need for clutch operation and gear shifting.

Second dead man handle¹

The second dead man function is integrated in the rotary grip, allowing one-handed operation temporarily.



Accelerator lever

For setting the motor speed.



Immobilisation brake

The immobilisation brake acts mechanically on both wheels, ensuring complete safety and peace of mind.

Cockpit: M models

Engine

Easy-start powerful petrol engine that represents the state of the art in terms of performance and emissions.

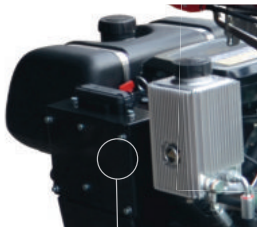

Controller¹

The controller is protected by the battery compartment.



Power take-off control

The power take-off, which is mechanically coupled to the engine speed, can be easily switched on and off at the touch of a button.

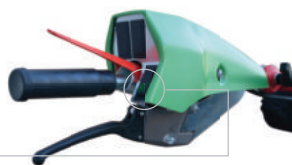

Quick change system

Allows you to change the various attachments in a flash and without any need for tools.

Tyres

Flexible range of wheels and combination options tailored to your needs for optimum traction according to the specific application.

Zero-turn steering

Wheels that turn in opposite directions allow soil-conserving turning manoeuvres in the tightest of spaces.

Handlebar end adjustment

Knurled screws allow you to adjust the handlebar ends quickly and without tools so that you can work safely and ergonomically on difficult terrain whatever the situation.

Handlebar and hand lever steering

Depending on the working situation, you can choose to carry out steering manoeuvres precisely and easily using handlebar or hand lever steering.



Lifting eye

For safe lifting and fastening.

Freewheeling selection

Allows you to manoeuvre and tow the machine without starting up the engine.

Wheels and wheel combination examples



AS 5.00-10



Wheel combination

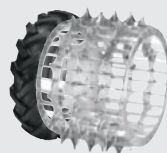

Wheel combination



BR 21x11.00-10



RB 23x8.50-12



RB 20x8.00-10

Rapid VAREA Attachments

NEW!

NEW!



WALK-BEHIND TRACTOR MODEL		VAREA	VAREA	VAREA	VAREA	VAREA	VAREA
Attachment name	Features	M141	S141	M161	S161	M231	S231
Middle cut sickle bar 190 cm	Finger spacing 2"/50.8 mm, with outer shoe or side cutting mechanism	•	•	-	-	•	-
Middle cut sickle bar 220, 250 cm	Finger spacing 2"/50.8 mm, with outer shoe or side cutting mechanism	•	•	•	•	•	•
Middle cut sickle bar 280 cm	Finger spacing 2"/50.8 mm, with outer shoe or side cutting mechanism	-	-	•	•	•	•
Normal cut sickle bar 190 cm	Finger spacing 3"/76.2 mm, with outer shoe or side cutting mechanism	•	•	-	-	-	-
Normal cut sickle bar 220, 250 cm	Finger spacing 3"/76.2 mm, with outer shoe or side cutting mechanism	•	•	•	•	•	•
Normal cut sickle bar 280 cm	Finger spacing 3"/76.2 mm, with outer shoe or side cutting mechanism	-	-	•	•	•	•
Landscaping cutter bar 122, 142 cm	No fingers, no clogging, sprung/adjustable hold-down device	-	-	-	-	•	•
Landscaping cutter bar 162 cm	No fingers, no clogging, sprung/adjustable hold-down device	•	•	•	•	•	•
Diamant cut sickle bar 220 cm	Finger spacing 58 mm, with outer shoe or side cutting mechanism	•	•	•	•	-	-
Diamant cut sickle bar 244cm	Finger spacing 58 mm, with outer shoe or side cutting mechanism	-	-	-	-	•	•
Broad gauge mower 200 cm	Bidux dual cutter bar system, does not clog up	•	•	•	•	•	•
Broad gauge mower 230 cm	Bidux dual cutter bar system, does not clog up	-	-	•	•	•	•
Broad gauge mower 260 cm	Bidux dual cutter bar system, does not clog up	-	-	-	-	•	•
Compact zero grazer 203, 206 cm	Finger spacing 2"/50.8 mm or finger spacing 3"/76.2 mm	-	-	-	-	•	•
Twister hayrake 180, 220 cm	Lateral downward forage conveying	•	•	•	•	•	•
Multi-Twister 190 cm	Active lateral forage conveying at both sides	•	•	•	•	•	•
Multi-Twister 220 cm	Active lateral forage conveying at both sides	-	-	•	•	•	•
Round baler CAEB	Working width 100 cm, bale diameter 55 cm, bale width 52 cm	-	-	-	-	•	•
Eco-Mulcher 80 cm	Continuous height adjustment, driven on skids	•	•	•	•	•	•
Flail mulcher 70 cm	Cutting height 20 – 100 mm, Y-blade	•	•	-	-	-	-
Flail mulcher 90 cm	Cutting height 20 – 100 mm, Y-blade	•	•	•	•	•	•
Flail mulcher 110 cm	Cutting height 20 – 100 mm, Y-blade	-	-	•	•	•	•
Flail mulcher 130 cm	Cutting height 20 – 100 mm, Y-blade	-	-	-	-	•	•
Combi-Sweeper 110 cm	Universal brush ø 42 cm	•	•	•	•	•	•
Levelling harrow	Working width 150 cm	•	•	•	•	•	•
Stone burier 90 cm	Lateral drive, tilling depth 14 cm	•	•	•	•	•	•
Rotary harrow 100 cm	Adjustable working depth	•	•	•	•	•	•
Rotary harrow 125 cm	Adjustable working depth	-	-	-	-	•	•
Rotary tiller 90 cm	Rotary tilling direction can be adjusted	-	•	-	•	-	•
Snowplough 125 cm	Sprung, can be swivelled sideways from the handlebar	•	•	•	•	•	•
Snowplough 150 cm	Sprung, can be swivelled sideways from the handlebar	-	-	•	•	•	•
Snow thrower 70 cm	Ejection chamber and gate adjustable from the handlebar	•	•	•	•	-	-
Snow thrower 87 cm	Ejection chamber and gate adjustable from the handlebar	•	•	•	•	•	•
Snow thrower 105 cm	Ejection chamber and gate adjustable from the handlebar	-	-	-	-	•	•
Path maintenance unit 90 cm	For water-bound areas	•	•	•	•	•	•
Weed brush 90 cm	For solid surfaces	-	-	•	•	•	•
Weed brush WKB 60 cm	For eliminating weeds from edges, sides and paved areas	•	•	•	•	•	•
Drilling container	For fitting to the Uni-Rotary Harrow 100 cm	•	•	•	•	•	•



Handlebar lateral adjustment/rotation

With all models, the handlebar can be adjusted laterally without the need for tools. This makes it easy to work alongside obstacles or under bushes.

With the S models, the handlebar can in addition be turned by 232° and locked in 6 positions.



Rapid Soft handlebar bearing









The revolutionary Rapid Soft handlebar bearing, which is decoupled from the walk-behind tractor unit, reduces vibrations and oscillations to an incomparable degree and offers maximum ease of use especially with oscillating attachments.

Rapid

Rapid ORBITO

For easy working with heavy attachments

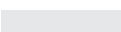

- Mowing technology 
- Forage harvesting 
- Mulching technology 
- Cleaning 
- Tilling 
- Winter services 
- Transport 
- Special applications 



Rapid ORBITO – High-performance walk-behind tractor with hydraulic axle adjustment



The needs of the operator when working with heavy attachments are top priority with the Rapid ORBITO. The balance is adjusted using the axle, which can be adjusted at the push of a button. The ergonomically arranged operating elements make the appliance simple and intuitive to operate.

Technical data	ORBITO 660	ORBITO 640	ORBITO 620
Engine	Briggs & Stratton Vanguard		Subaru Robin EX40
Type	4-stroke OHV petrol engine, air-cooled		
Cubic capacity	627 ccm		404 ccm
Cylinders	2		1
Max. power	23 PS / 16.9 kW		14 PS/10.3 kW
Starter	Electric starter (with additional manual recoil starter)	Recoil starter	
Weight	255 kg (without wheels)	238 kg (without wheels)	224 kg (without wheels)
Ability to handle slopes	100%		
Travel drive	Hydrostatic, continuous speed adjustment forwards and in reverse		
Speed	Forwards: 0 – 8 km/h, reverse: 0 – 4 km/h		
Power take-off (PTO)	700 and 1000 rpm		
Clutch	Electro-magnetic clutch		
Steering	Hydraulic handlebar and hand lever steering, switchable		
Connection flange	Tool-free rapid change system Ø 78/80		
Handlebar	Can be swivelled without tools (232°), lockable in 6 positions, height-adjustable without tools (11 positions), with vibration damping		
Free wheel change	Mechanical free wheel, towable		
Axle adjustment	150 mm, hydraulically adjustable, with adjustable end positions		
Immobilisation brake	Mechanical, acts on both wheels		
Additional hydraulics	Optional, two dual-acting control devices		

Success factors

- Continuously variable travel drive, no need for clutch operation and gear shifting
- Active hand lever or handlebar steering, for effortless and precise working
- Perfect device combination balance thanks to axle which can be adjusted when stationary or while driving
- Zero-turn steering for soil-conserving turning manoeuvres in tight spaces
- Tool-free attachment quick-change system
- All relevant operating elements can be actuated without letting go of the handlebar ends



Mr Janko, Technical Department, DARS d.d. Celje, Slovenia

«We can maintain the green areas alongside the entire Slovenian motorway network without obstructing the traffic flow. I really appreciate the performance capability, comfort and ease of operation of the Rapid ORBITO.»

Handlebar steering

Applying lateral pressure to the vibration-cushioned handlebar actuates the active steering depending on the amount of force. The drive wheels therefore rotate at different speeds. Precise steering manoeuvres are easily implemented.

Switch

For switching between handlebar and manual lever steering and setting the axle position.

Dead man handle

If the dead man handle is released for some reason or other, the power take-off and the travel drive are immediately switched off for safety reasons.

Handlebar end adjustment

Rapid, tool-free handlebar end adjustment for working safely and ergonomically on any terrain.

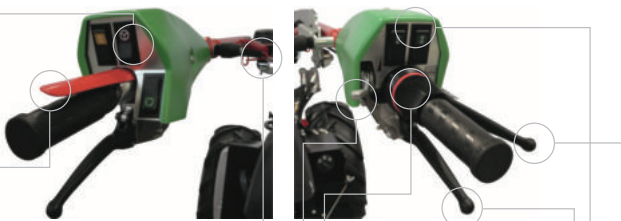

Accelerator lever

For setting the engine rpm.

Switch

For actuating the additional hydraulics.

LED lights

Optional additional equipment.

Rotary grip

Continuously variable forward or reverse travel without any need for clutch operation and gear shifting. With integrated second dead man function.

Hand lever steering

The active steering is enabled by operating the hand lever, allowing precise steering manoeuvres to be carried out, even in difficult situations.

Swivel and laterally adjust the handlebar

Actuating the hand lever allows the handlebar to be swivelled and locked in six positions.

Hour counter

Installed as standard as a display for the operating hours and the engine rpm.

Fuses

Easily accessible and protected with a cover.

Additional hydraulics

Thanks to the optional additional hydraulics, equipment such as snowploughs and heavy tilling attachments can be easily operated from the cockpit while travelling.



Free wheel change

Allows you to manoeuvre and tow the machine without starting up the engine.



Handlebar height adjustment

The handlebar has eleven different height settings.

Tyres

Flexible range of wheels and combination options tailored to your needs for optimum traction according to the specific application.

Quick change system

For rapid, tool-free attachment changing.



Crane and lashing eyelets

For safe lifting and securing loads.

Wheels and wheel combination examples





WALK-BEHIND TRACTOR MODEL ORBITO

Attachment name	Features	
Middle cut sickle bar 220, 250 cm	Finger spacing 2"/50.8 mm, with outer shoe	•
Middle cut sickle bar 220, 250, 280, 310 cm	Finger spacing 2"/50.8 mm, with side cutting mechanism	•
Normal cut sickle bar 220, 250 cm	Finger spacing 3"/76.2 mm, outer shoe	•
Normal cut sickle bar 220, 250, 280, 310 cm	Finger spacing 3"/76.2 mm, with side cutting mechanism	•
Broad gauge mower 200, 230, 260 cm	Bidux dual cutter bar system, does not clog up	•
Twister hayrake 220 cm	Lateral downward feed conveyance	•
Multi-Twister 190, 220 cm	Active lateral forage conveying at both sides	•
Compact drive 203, 206 cm	Finger spacing 2"/50.8 mm or 58 mm	•
Hayrake	Working width 150, 180 cm, total width 210, 240 cm	•
Flail mulcher 90, 110, 130 cm	Cutting height 20 – 100 mm, Y-blade	•
Combi-Sweeper 110 cm	Universal brush Ø 42 cm	•
Side brush	Brush Ø 52 cm for Combi-Sweeper	•
Levelling harrow	Working width 150 cm	•
Stone burier 90 cm	Lateral drive, tilling depth 14 cm	•
Uni-Rotary Harrow 100, 125 cm	Adjustable working depth	•
Snowplough 125, 150 cm	Sprung, can be laterally swivelled from the handlebar	•
Snow thrower 87, 105 cm	Ejection chamber and gate adjustable from the handlebar	•
Drilling container 44 l	For mounting on the 100 cm Uni-Rotary Harrow	•
Sand cleaning appliance	Dirt collected in removable container	•
Weed remover 90 cm	For solid surfaces	•
Path maintenance unit 90 cm	For water-bound areas	•

MOWING TECHNOLOGY
FORAGE HARVESTING
MULCHING TECHNOLOGY
CLEANING
TILLING
WINTER SERVICES
TRANSPORT
SPECIAL APPLICATION

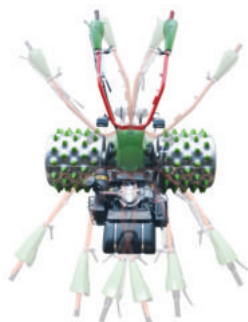

Swivelling and rotating



Hydraulically adjustable axle handlebar

Incomparably comfortable working

The swivelling and laterally adjustable handlebar and the pushbutton-adjustable axle make it possible to even work on difficult terrain and around obstacles simply, safely and efficiently.

Rapid

Mowing technology

The perfect professional system for every application

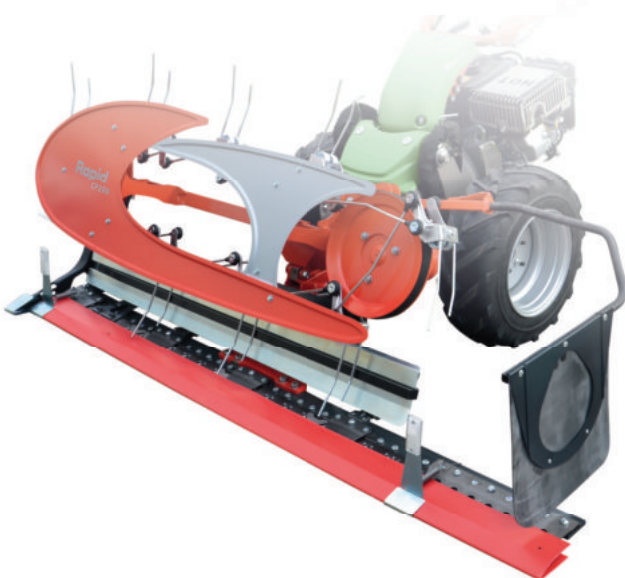

Mowing technology

Forage harvesting

Mulching technology

Cleaning

Tilling

Winter services

Transport

Special applications



Tried and tested cutting technology with state of the art materials for the perfect cut every time



Rapid invented the single axle mower in 1926. The associated grass mowing technology has been successfully developed over the generations. To fulfil the various needs of users, the public is able to choose from a wide range of mowing systems today. Each of these systems has its own special features and is geared towards a specific area of application for maximum performance with low maintenance requirements.



OVERVIEW OF MODELS AND FEATURES				
Features	System			
	Finger cutter bar	Landscaping cutter bar ESM	Dual cutter bar ESM	Broad gauge mower
Used for forage harvesting	*****	**	*****	*****
Used for maintenance of green areas	***	*****	****	**
Promotes rapid regrowth of forage	*****	***	*****	*****
Resistance to contamination	***	*****	*****	****
Low-vibration operation	****	***	*****	*****
No central cutter head; grass is positioned ideally for drying after the cut	***	***	***	*****
Fine gradation of bar width	*****	***	***	***
Different finger spacing available	Yes	No	No	No
Swathe panelling possible	Yes	No	No	No
Side cutting mechanism possible	Yes	No	No	No
Cutting height adjustment (optional skids)	Yes	Yes	Yes	Yes
Additional weights (optional)	Yes	Yes	Yes	Yes

General keys to success for the cutter bar

- Up to five times less energy required than systems with rotating cutting technology
- The ideal cutting height is continuously adjustable
- Soil-conserving operation thanks to the low ground pressure exerted and overall weight of the vehicle
- Extremely suitable for work on steep gradients due to its very low centre of gravity and low drive power, which ensures the machine is light
- Gentle on small creatures and insects, compared to a rotating cutting system – cutter bars are mandatory in part as a cutting system in ecological support programmes

Rapid oil lubricated **cutter heads** – robust, hard wearing, durable



Optional weights

If a significant bar bearing weight is required, an optional weight can be mounted on the cutter head.



Grass separation

The flow of mown grass over the hood of the cutter head can be separated easily by using the optional grass separation rod for certain grass stock. This reduces the risk of blockage and thus increases the level of efficiency.

Cutter head and cutter bar system

Cutter bars must be combined with a cutter head. The cutter head generates the oscillating cutting movement from the mechanical power take-off shaft and drives the blade centrally.

An exception to this rule are broad gauge mowers, in which the driving forces are directed laterally into the pair of blades by means of swing arms.

The keys to success

- Simple, low-maintenance and hard-wearing construction
- Broad product range; a compatible model is available for all walk-behind tractor models and their various tyre diameters
- Equipped with overload protection

Overload protection preventing subsequent damage



If foreign objects such as stones, pieces of iron, etc. come into contact with the cutter bars, or the side of the oscillating blade hits a solid obstruction while moving, the integrated safety clutch will provide protection from subsequent damage (with the exception of the cutter heads for the Rapid Mondo series).



Cutter head, driving fork and cutter bar

Low maintenance cutter heads



The gear parts of all Rapid cutter heads are located in an oil bath. This ensures minimum friction losses and low wear. The maintenance costs of the enclosed system are minimised with a maximum service life.

Rapid **finger cutter bars** – efficient harvesting for all kinds of forage



Middle cut sickle bar

Finger spacing 2" / 50.8 mm

A precise cut means rapid regrowth of the forage

Rapid finger cutter bars are mainly used for agricultural applications where an exact cut is required. In comparison to rotating grass cutting systems, finger cutter bars allow the grass to regrow up to ten days earlier, which increases the amount of forage for each area.



Diamant cut sickle bar

Finger spacing: 58 mm

Suitable finger spacing for forage and ground conditions



Rapid offers three types of finger cutter bar, namely the middle cut, Diamant cut and normal cut bar.

These differ mainly in terms of their finger spacing. Each of these bars has their own advantage depending on the forage, density, and ground conditions present.



Normal cut sickle bar

Finger spacing 3" / 76.2 mm

Outer shoe versus side cutting mechanism



Outer shoes or side cutting mechanisms ensure trouble-free mowing at the outer area of the cutter bars. The side cutting mechanism allows passing through already cut grass without any clogging. In contrast, the outer shoes with swathing plates feed the cut grass inwardly. These are primarily used on uneven, rocky terrain or if there is a low grass stock. The outer shoe projecting beyond the finger prevents the bar from "jamming" into rough terrain.

FEATURES AND AREAS OF APPLICATION OF THE VARIOUS TYPES OF FINGER CUTTER BAR

Features/areas of application	Type		
	Middle cut sickle bar	Diamant cut sickle bar	Normal cut sickle bar
	Finger spacing		
	2" / 50.8 mm	58 mm	3" / 76.2 mm
Very precise cut	*****	****	****
Fine crops / mountain area	*****	**	*
Dry areas	*****	***	***
Wet areas	***	****	*****
Clog-free operation for areas that exhibit numerous molehills	*	****	*****
Old grass stock or late harvested meadows	**	****	*****
Heavily fertilised, dense forage	**	****	*****
Horizontal forage caused by a storm, hail, snow, etc.	**	****	*****



Outer shoe with swathe panelling



Side cutting mechanism

Sophisticated and customised cutting technology maximises the result



Sophisticated geometry

Rapid has been optimising its finger geometry in meticulous detail for generations. The steps involved in forging the machinery and the exact final dimensions are a trade secret. Users benefit from the fact that the finger guides the cutter bar optimally and ensures a perfect cut in conjunction with the blade.



Serrated cutting edges for the most demanding requirements



Rapid finger cutting plates and cutter blades exhibit a serrated design. This ensures a maximum service life and significantly minimises maintenance costs for resharping.



Serrated cutting edges, maximum service life

Materials and workmanship of the highest quality



Rapid fingers are forged from high-strength alloys and are additionally annealed. This ensures the fingers have a tough core and a hard, durable surface. The extremely hard, serrated cutting plates that are riveted to the fingers offer a maximum cutting capacity with low energy consumption and a long service life. The bar is rolled from tough stainless steel in accordance with special Rapid specifications. It adapts ideally to uneven ground conditions and simultaneously exhibits a high degree of resistance to any force or impact that occurs in the direction of travel.



Additional weights for bars with side cutting mechanisms

An increase in the weight of the bar enhances comfort, especially when mowing on steep slopes.



Adjustable cutting height

The cutting height can be infinitely adjusted to the respective conditions by means of optional skids.

The keys to success

- Three different finger spacing settings – the ideal cutter bar for all grass stock
- Infinitely adjustable cutting height
- Rapid regrowth of forage thanks to a clean cut
- High quality components ensure a maximum service life
- Ideal for clean forage harvesting in the agricultural sector
- Lightweight design ensures extremely steep slopes can also be mowed
- Wide range of finely graduated bar widths

Tips & tricks

Professional tip

To enable maximum efficiency for each cut it can be worthwhile investing in a 2" and 3" finger cutter bar. This ensures professionals have the ideal cutter bar to hand for all kinds of forage. The blades used by these two types of bar are identical and can be interchanged.

ESM landscaping cutter bar – clog-free, efficient mowing in the municipal sector



Landscaping cutter bar



Immune to clogging



ESM landscaping cutter bars are ideal for mowing contaminated and heavily overgrown areas of grass. They are insensitive to foreign objects and are capable of easily mowing rotten cuttings and cuttings that have not been cleared away. This type of bar is therefore treasured by professionals in the gardening, landscaping and municipal sectors. Mowing along roadsides, ditches or embankments can be mastered efficiently.



Skids

Optional skids can be used to easily adjust the cutting height of the landscaping cutter bars.



Maximum comfort with skid weights

A higher bar bearing weight can be achieved by mounting skid weights, thereby favouring work on steep slopes.

Quick and easy blade replacement



A special wrench allows the swing arms to be pivoted to the side. This enables the blade with the blade head to be removed easily to the front. This facilitates quick and easy replacement of the blades.



Special wrench for removing the blades from the ESM landscaping cutter bar

The keys to success

- No clogging
- Insensitive to rotten cuttings and cuttings that have not been cleared away
- Insensitive to foreign objects
- Perfect blade guidance thanks to the swing arms
- Adjustable cutting height
- Simple maintenance

Gentle on insects

The cutter bar principle is the kindest mowing system for insects. This is because the animals have escape routes and are not trapped by the suction effect that is caused, for example, by rotary mowers.

Promotion of biodiversity



In contrast to the mulching of extensively used green areas, the mowing process with subsequent removal of the cut material extracts nitrogen from the ground, which promotes biodiversity.

Dual cutter bar – precise cut, clog-free and low-vibration operation



Dual cutter bar



Low-vibration and clog-free operation



The dual cutter bars operate with low vibration thanks to mutual counterbalancing of the oscillating blades. The fingerless cutter bar mows all kinds of grass and is clog-free. Dual cutter bars are used in the agricultural sector for the production of forage or in the municipal, gardening and landscaping sectors for maintaining grassland areas. In comparison to the landscaping cutter bar these offer a higher average cutting capacity and a more accurate cut.

Long service life, no readjustment of the guide

The cutter blades exhibit a long service life thanks to the patented ESM Carbodux® hardening process.



"Busatis" system

In the Busatis system the blades are guided via upper and lower swing arms.

The keys to success

- Comfortable handling thanks to low-vibration operation
- No clogging
- Cuts all types of grass
- High cutting speeds
- No readjustment of the lower guides necessary
- Long service life thanks to patented ESM Carbodux® mowing blades
- Production of clean forage



Dual cutter bars are equipped with additional weights and skids as standard

Environmentally friendly



The dual cutter bar principle is deemed an environmentally friendly mowing system. Energy requirements are low on one hand, while, unlike the mulching method, insects are also protected on the other.

Rapid **broad gauge mower** – maximum acreage performance, clean forage deposit, clog-free operation



Broad gauge mower, Bidux system



Easy transportation

Optional transport wheels protect the skids when driving on and off-road and facilitate easy transportation and manoeuvrability.

Maximum acreage performance

Bar widths of up to 2.30 m are used for the rugged frame construction of broad gauge mowers, which enables extremely high acreage performance. This makes broad gauge mowers particularly popular in the agricultural sector. They are, however, also widely used in the municipal, gardening and landscaping sectors.

The keys to success

- High acreage performance thanks to high mowing speeds and large cutting widths
- Comfortable handling thanks to low-vibration operation
- No clogging
- Long service life thanks to patented ESM Carbodux® mowing blades
- Production of clean forage

Maximum comfort



Broad gauge mowers, like the dual cutter bars, operate with low vibration thanks to mutual counterbalancing of the oscillating blades.



Lateral drive of broad gauge mower

Clean forage deposit



A clean deposit of the forage is guaranteed across the entire width of the bar thanks to the lateral drive of the cutting blade. This ensures even and accelerated drying of the forage.

Optional extras and accessories help make work more comfortable and efficient

Optional accessories specifically tailor Rapid mowing systems for special requirements or enhanced comfort. This also allows efficiency and safety to be maximised in extraordinary situations.

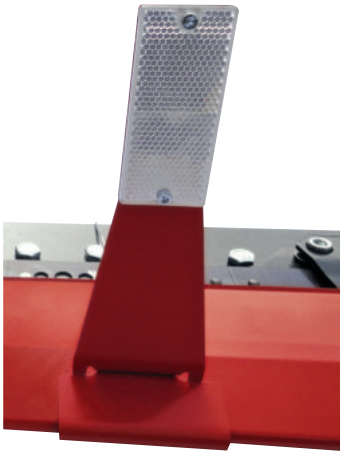

Safety provided by double reflectors

Vehicles are made more visible to other road users at night thanks to the double reflectors. These are suitable for driving on public roads in accordance with the highway code.

Winding protection



If, with Rapid Rex or Swiss, sprocket wheels are used on wider axles without rubber tyres, the winding protection can be used to reduce the amount of cut grass rolling up. The winding protection is fitted over the attachment flange. An omission of AS rubber tyres enhances the effect: Firstly, more space is created for the supply of forage between the wheel and the machine. And secondly, no winding can occur due to the angular AS cleats.

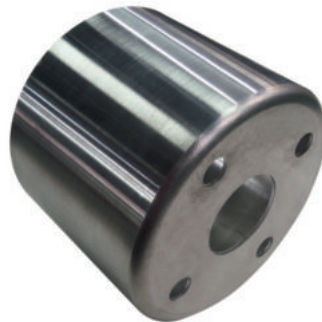

Winding protection reduces the amount of grass rolling up

Axle extension



The easy to assemble axle extension allows the machine's centre of gravity to be lowered, which has a positive effect on its ability to operate on slopes.

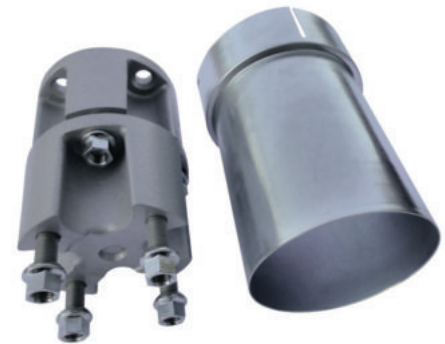

Sprocket wheel ensures maximum traction and safety on steep slopes

Tips & tricks

Mow even steeper terrain with sprocket wheels



The omission of AS tyres and the use of winding protections on the attachment flanges enable mowing operations on significantly steeper terrain. The reason for this is that when the AS tyres are removed the spikes are able to penetrate deeper into the soil, thereby creating maximum traction.

Rapid Compact zero grazer – tried and tested technology for soil conservation and efficient forage harvesting



Simple transportation over long distances

The drawbar can be attached directly to the Compact zero grazer without having to lift the cutter bar. The Compact zero grazer can be towed at higher speeds when attached to a tractor or loading wagon thanks to the travel drive free wheel change function.



Clean forage in double swaths – ideal for loading wagons



Rapid's tried and tested Compact zero grazer makes forage harvesting procedures simple and efficient. The compact design and optimum weight distribution enable a perfect cut and clean production of forage, even under difficult conditions. A double swath, which is ideal for loading wagons, is created in two runs that are conducted in opposite directions.

Different levels of convenience

Rapid is offering different carrying vehicles for the Compact zero grazer in the form of the Rapid Monta and Euro basic machines. The most cost-effective variant is the combination with the Rapid Euro 3 CP, which does not have active steering. The models with active steering are the Rapid Euro 4 CP with hand lever steering and the Rapid Monta, with which it is possible to switch between hand lever steering and handlebar steering.

The keys to success

- Perfect cut, rapid regrowth of forage
- Clean and fresh forage in double swaths – ideal for loading wagons
- Operation ensured even under difficult conditions, e.g. on wet ground
- Work without damaging the ground thanks to the low overall weight
- Easy to use, even on slopes



Convenient lubrication



The optional handlebar-mounted grease gun ensures simple lubrication of the driving rod even during use.



Cover sheet

The rugged cover sheet supplied protects the machine from the effects of the weather when it is left standing in the field and guarantees a long service life.

The original – compact, efficient, proven

Non-slip drive

The compact drive ensures slip-free power transmission to the feed unit via a drive shaft and angular gear.

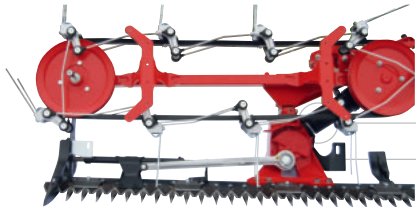

3 axle drive with overload protection

The heart of the machine in a confined space; designed for maximum reliability and durability. The oil lubricated safety clutch only affects the blade and can therefore be adjusted in a very fine and accurate manner. This prevents blade breakage.

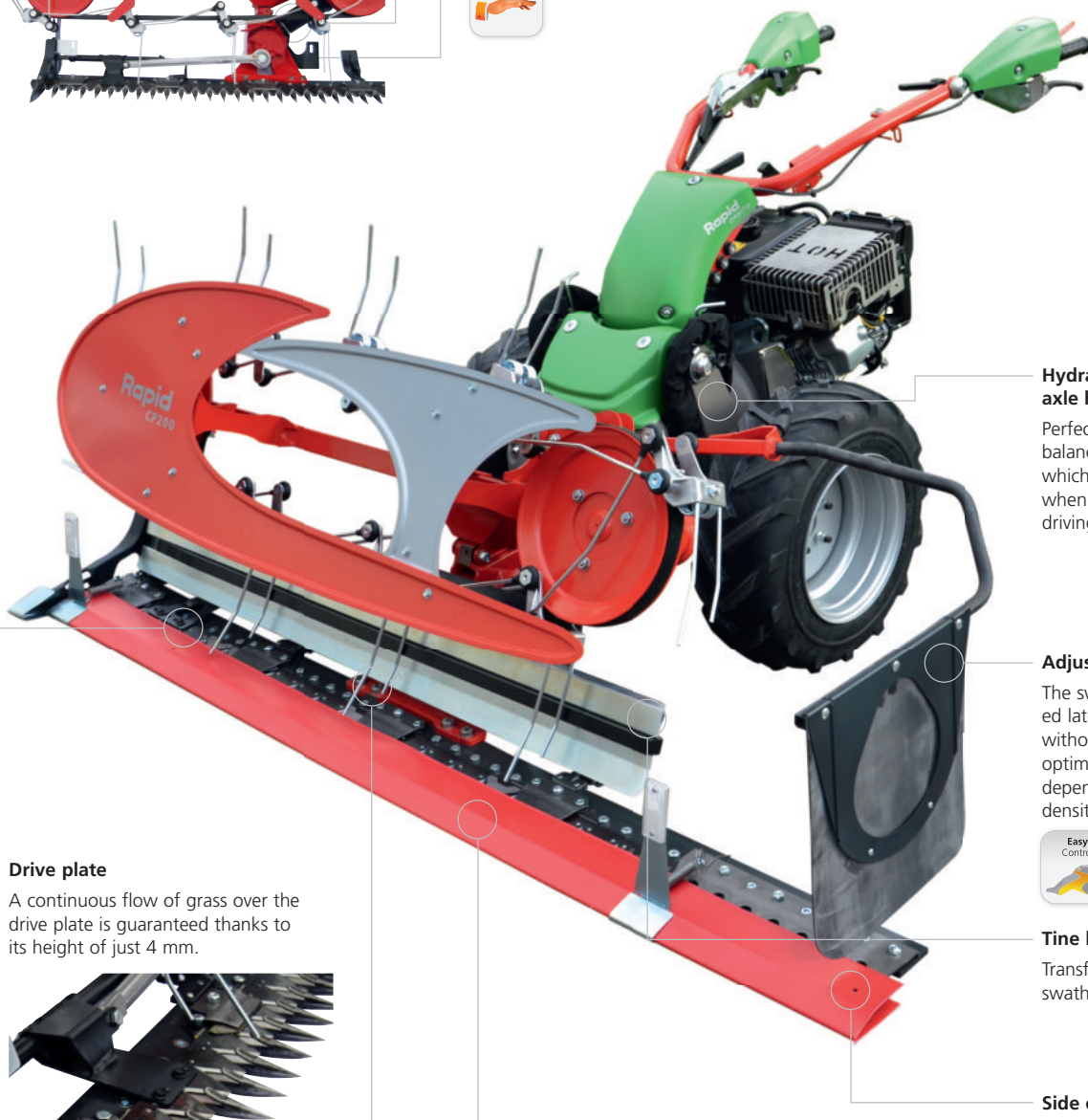

Drive plate

A continuous flow of grass over the drive plate is guaranteed thanks to its height of just 4 mm.



Feed unit

The low position of the feed unit enables an optimum, efficient output capacity for all kinds of forage.

Two cutter bar types to choose from

The 203 cm wide Rapid Diamant cut sickle bar and the 206 cm wide Rapid middle cut sickle bar are available for selection.



Hydraulically adjustable axle handlebar

Perfect device combination balance thanks to axle which can be adjusted when stationary or while driving.

Adjustable swath flap

The swath flap can be adjusted laterally and vertically without tools to ensure an optimum swath is created depending on the forage density.



Tine belt

Transfers the forage to the swath cleanly and efficiently.

Side cutting mechanism

Prevents clogging when driving under the already cut swath.

Cutter bars

Overview of types and compatibility

	REX	MONDO	SWISS	MONTA M141	MONTA S141	MONTA M161	MONTA S161	VAREA M141	VAREA S141	VAREA M161	VAREA S161	VAREA M231	VAREA S231	ORBITO
WALK-BEHIND TRACTOR MODEL														
Attachment name														
Middle cut sickle bar 130 cm, finger spacing 2" / 50.8 mm ^{*1}	•	•	•	•	•	•	•	-	-	-	-	-	-	-
Middle cut sickle bar 145 cm, finger spacing 2" / 50.8 mm ^{*1}	•	•	•	•	•	•	•	-	-	-	-	-	-	-
Middle cut sickle bar 160 cm, finger spacing 2" / 50.8 mm ^{*1}	•	•	•	•	•	•	•	-	-	-	-	-	-	-
Middle cut sickle bar 190 cm, finger spacing 2" / 50.8 mm ^{*1}	-	-	•	•	•	•	•	•	•	-	-	-	-	-
Middle cut sickle bar 220 cm, finger spacing 2" / 50.8 mm ^{*1}	-	-	-	•	•	•	•	•	•	•	•	•	•	•
Middle cut sickle bar 250 cm, finger spacing 2" / 50.8 mm ^{*2}	-	-	-	•	•	•	•	•	•	•	•	•	•	•
Middle cut sickle bar 280 cm, finger spacing 2" / 50.8 mm ^{*2}	-	-	-	-	-	•	•	-	-	•	•	•	•	•
Middle cut sickle bar 310 cm, finger spacing 2" / 50.8 mm ^{*2}	-	-	-	-	-	-	-	-	-	-	-	-	-	•
Normal cut sickle bar 130 cm, finger spacing 3" / 76.2 mm ^{*1}	•	-	•	•	•	•	•	-	-	-	-	-	-	-
Normal cut sickle bar 145 cm, finger spacing 3" / 76.2 mm ^{*1}	•	-	•	•	•	•	•	-	-	-	-	-	-	-
Normal cut sickle bar 160 cm, finger spacing 3" / 76.2 mm ^{*1}	•	-	•	•	•	•	•	-	-	-	-	-	-	-
Normal cut sickle bar 190 cm, finger spacing 3" / 76.2 mm ^{*1}	-	-	•	•	•	•	•	•	•	-	-	-	-	-
Normal cut sickle bar 220 cm, finger spacing 3" / 76.2 mm ^{*1}	-	-	-	•	•	•	•	•	•	•	•	•	•	•
Normal cut sickle bar 250 cm, finger spacing 3" / 76.2 mm ^{*2}	-	-	-	•	•	•	•	•	•	•	•	•	•	•
Normal cut sickle bar 280 cm, finger spacing 3" / 76.2 mm ^{*2}	-	-	-	-	-	•	•	-	-	•	•	•	•	•
Normal cut sickle bar 310 cm, finger spacing 3" / 76.2 mm ^{*2}	-	-	-	-	-	-	-	-	-	-	-	-	-	•
Diamant cut sickle bar 174 cm, finger spacing 58 mm ^{*1}	-	-	-	•	•	•	•	-	-	-	-	-	-	-
Diamant cut sickle bar 197 cm, finger spacing 58 mm ^{*1}	-	-	-	•	•	•	•	-	-	-	-	-	-	-
Diamant cut sickle bar 220 cm, finger spacing 58 mm ^{*1}	-	-	-	•	•	•	•	•	•	•	•	-	-	-
Diamant cut sickle bar 244 cm, finger spacing 58 mm ^{*2}	-	-	-	•	•	•	•	•	•	•	•	•	•	-
Landscaping cutter bar 122 cm, no fingers, no clogging	•	•	•	•	•	•	•	-	-	-	-	•	•	-
Landscaping cutter bar 142 cm, no fingers, no clogging	•	•	•	•	•	•	•	-	-	-	-	•	•	-
Landscaping cutter bar 162 cm, no fingers, no clogging	-	•	•	•	•	•	•	•	•	•	•	•	•	-
Dual cutter bar 132 cm, Bidux system, incl. skid weights	-	•	•	•	•	•	•	-	-	-	-	-	-	-
Dual cutter bar 146 cm, Bidux system, incl. skid weights	-	•	•	•	•	•	•	-	-	-	-	-	-	-
Dual cutter bar 181 cm, Bidux system, incl. skid weights	-	-	•	•	•	•	•	•	•	•	•	•	•	-
Dual cutter bar 204 cm, Bidux system, incl. skid weights	-	-	-	•	•	•	•	•	•	•	•	•	•	-
Broad gauge mower 160 cm, Bidux system	-	-	-	•	•	•	•	-	-	-	-	-	-	-
Broad gauge mower 200 cm, Bidux system	-	-	-	•	•	•	•	•	•	•	•	•	•	•
Broad gauge mower 230 cm, Bidux system	-	-	-	-	-	•	•	-	-	•	•	•	•	•
Broad gauge mower 260 cm, Bidux system	-	-	-	-	-	-	-	-	-	-	-	•	•	•
Compact zero grazer	-	-	-	•	•	•	•	-	-	-	-	•	•	•

^{*1} with outer shoe or side cutting mechanism ^{*2} with side cutting mechanism

Rapid

Twister Hayrake

Pick-up and transport of crop
on extremely steep slopes



- Mowing technology
- Forage harvesting
- Mulching technology
- Cleaning
- Tilling
- Winter services
- Transport
- Special applications



Simple, reliable and non-damaging pick-up of fodder and efficient transport, even on extremely steep slopes



Twister hayrakes are designed for working on steep slopes. They replace painstaking manual work by several persons with rakes and pitchforks with a single operator on a single-axle walk-behind tractor. Picking up and transporting dry crop as well as transportation to less steep slopes for pick-up using a baler or a loading wagon are therefore simple to do. Work is made much easier and a great deal of time is saved compared to conventional manual work.

OVERVIEW OF MODELS AND FEATURES

Art. no.	1551	1552	1553
Working width	140 cm	180 cm	220 cm
Depth guide	Feeler wheels with adjustable height	Feeler wheels with adjustable height	Feeler wheels with adjustable height
Tine spacing	35 mm	35 mm	35 mm
Weight	85 kg	110 kg	135 kg
Connection flange	52/54 mm	78/80 mm	78/80 mm

Success factors

- Light weight makes it possible to work easily and safely while protecting the soil, even on extremely steep slopes
- Flexible plastic tines mean that fodder is picked up neatly without causing damage on any terrain
- Hay pick-up and transport downhill in a large ball when travelling along contour lines
- Collection device makes it possible to pick up and transport sideways and uphill
- Low crumbling losses
- Pick-up procedure is favourable for biodiversity
- Low noise generation

Environmentally friendly applications and protective deployment

 The usage weight and the pick-up device are extremely gentle for both the soil and the sward. The procedure causes little noise emission and does not affect biodiversity.

Safe operation

 The light weight and the stable side guidance by the feeler wheels when travelling along contour lines make it possible to work effortlessly and safely.

Tremendous time savings

 The use of Twister hayrakes saves a tremendous amount of time. Depending on the terrain, the crop and the working method, the manual work of several persons can be carried out in a much shorter time with this attachment.

Clean fodder pick-up thanks to plastic tines

The flexible plastic tines adapt themselves to cropped terrain, thereby ensuring that the crop is picked up very cleanly. In addition to protecting the soil and the sward, the amount of fodder soiling is minimal. Crumbling losses are also extremely low thanks to the gentle pick-up.



If working above obstacles, the equipment should initially be used in the transport position, and the dry crop transported to convenient locations. Thus, also large quantities can be easily picked up and transported along contour lines or uphill. After that, you can again work steadily downhill along contour lines.



Manual after-raking is practically no longer required.

Reliable depth control using feeler wheels

The height-adjustable feeler wheels are arranged close to the pick-up.

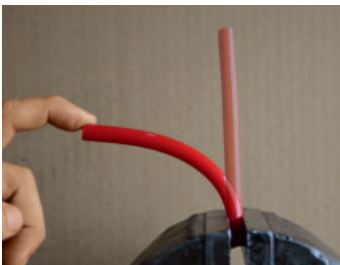

The plastic tines are made from an elastic and extremely hard-wearing material. The amount of wear is low, and the service life is appropriately long.



This allows optimum adaptation to the nature of the terrain and the cutting height.



The side sections can be engaged in the transport position or the deflection position



The side sections are moved into the deflection position for a downhill flow of material. The crop is kept away from the walk-behind tractor, and the side sections help the hay to roll downhill by a twisting and pulsing effect.

Side transport is interrupted by moving the side sections to the transport position. The crop is gathered by the pick-up, placed onto the area between the pick-up and the rear wall and can be transported to its destination this way.



Fatigue-free working



Optimum coordination of the walk-behind tractor and the attachment with regard to weight, balance and motor power in relation to the working width was taken into consideration in the design. Easy, fatigue-free working is therefore possible.

Easy replacement of plastic tines

The plastic tines have a long service life but can be replaced without removing any other parts if required (e.g. wear or damage).

Twister Hayrake

Overview of types and compatibility

WALK-BEHIND TRACTOR MODEL		REX	MONDO	SWISS	MONTA M141	MONTA S141	MONTA M161	MONTA S161	VAREA M141	VAREA S141	VAREA M161	VAREA S161	VAREA M231	VAREA S231	ORBITO
Attachment name	Art. No.														
Twister hayrake 140, including fixed deflector tines, working width 140 cm	1551	•	-	-	-	-	-	-	-	-	-	-	-	-	-
Twister hayrake 180, including side section for deflection and transport position, working width 180 cm	1552	-	-	•	•	•	•	-	-	-	-	-	•	•	-
Twister hayrake 220, including side section for deflection and transport position, working width 220 cm	1553	-	-	-	•	•	•	-	-	-	-	-	•	•	•

All kinds of applications



Twister hayrakes from Rapid can be used to carry out different types of work efficiently.

- Pick-up and side downhill transportation of dry crop when travelling along the contour lines on steep slopes
- Pick-up and transportation of dry crop when travelling along the contour lines or uphill



The result: Pick-up and downhill transportation of the dried crop without residue

Rapid

Multi-Twister

Pick-up and transport of crops on slopes and level surfaces

NEW!

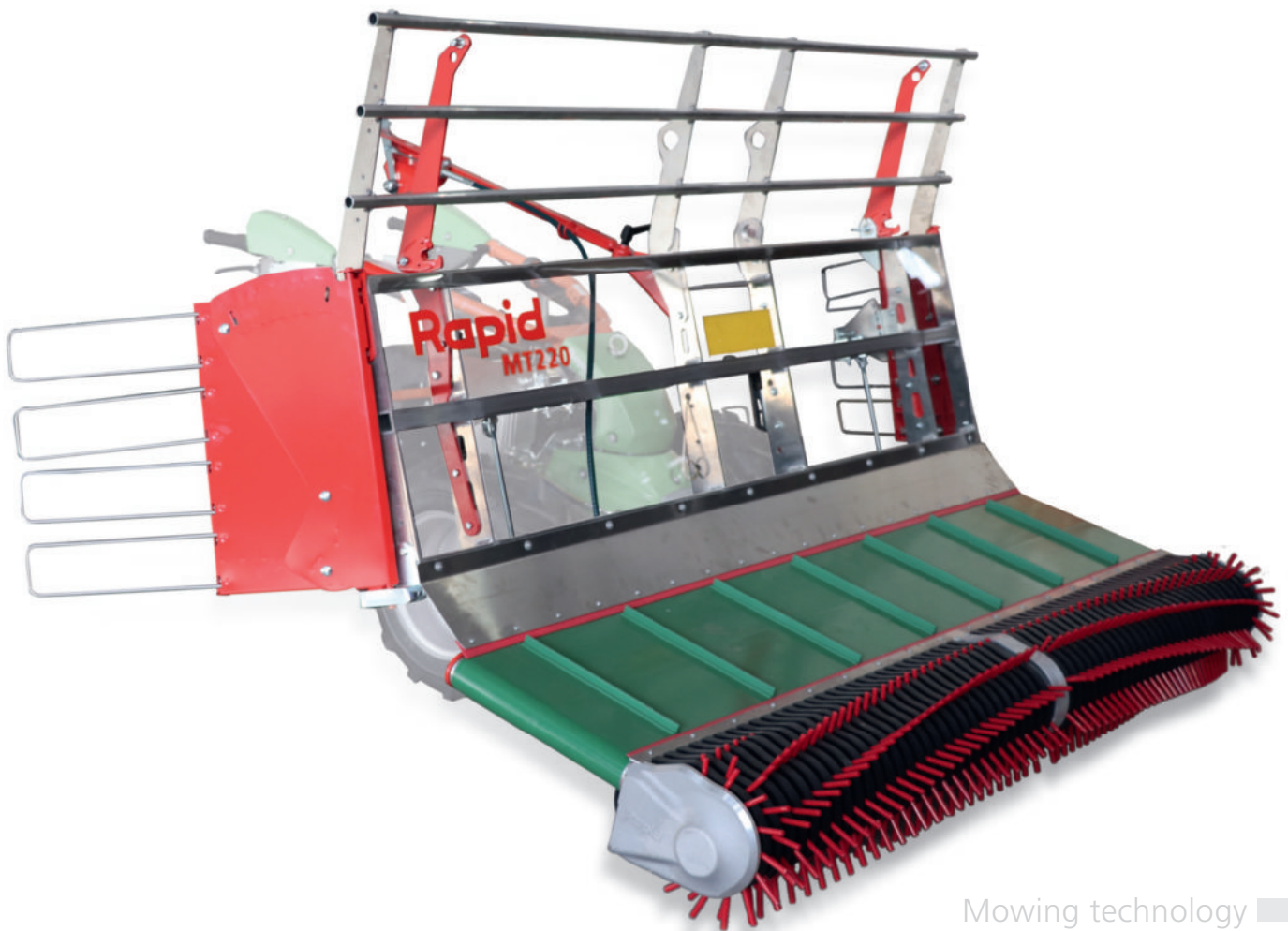

- Mowing technology
- Forage harvesting
- Mulching technology
- Cleaning
- Tilling
- Winter services
- Transport
- Special applications



Rapid Multi-Twister – gentle forage pick-up and efficient discharge with active lateral transport



The Rapid Multi-Twister has a conveyor belt with which the crop is actively transported to the side after being collected by the well-trying pick-up. Deployment on slopes and on level surfaces is therefore possible. Furthermore, the active discharge increases the range of uses with regard to green forage and silage. The conveyor belt also makes the «swathe» work operation possible from a procedural point of view.



MODEL OVERVIEW AND TECHNICAL DATA

Article no.	1643	1644
Working width	190 cm	220 cm
Weight	170 kg without options	205 kg without options
Connection flange	78/80mm	
Depth guide	Height-adjustable feeler wheels, 8 settings + park position	
Side parts	Optional, for transport or deflection position	
Attachment grille	Optional, for large quantities of forage	
Roller hold-down device		Optional, for better forage flow on the pick-up and lateral transport

Success factors

- Pick-up with well-trying flexible plastic tines
- Active lateral transport by conveyor belt
- Conveyor belt with right-hand and left-hand running and zero position
- Load-switchable reverse gear unit
- Robust chassis with easy height adjustment
- Use in different forage possible
- Additional «swathe» function possible

Roller hold-down device



If the crop is extremely short, the roller hold-down device can improve the flow of material.

The forage can therefore not escape upwards and is not pushed forward. It is deposited directly onto the conveyor belt via the pick-up.

Additional swathe function



Swathes can be produced with the Multi-Twister in order to prepare a mown area for transport by loading wagon, bale press or forage harvester.



Active lateral transport

The conveyor belt is adjusted at the handlebar using an operating lever. A gearbox that is easy to shift under load makes right-hand and left-hand running possible, and also a zero position. The conveyor belt has cross-bars so that the crop is securely held and transported. The conveyor belt is pre-tensioned automatically.

Other approaches and working procedures are possible

The gentle pick-up and the minimal amount of forage soiling means that several working widths can be combined on a swathe with small forage quantities in the autumn, without affecting the quality of the fodder.



Easily adjustable working height



Depth control is carried out by the two pairs of feeler wheels. These are adjusted on the rear panel without tools. The lowest one of the 8 positions brakes the feeler wheels and represents the park position.

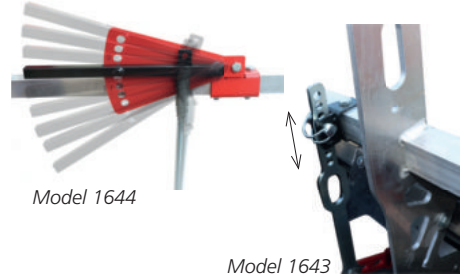

Side parts

In the deflection position, the crop is kept away from the basic machine by the side parts. In the transport position, the side parts are swivelled upwards and the conveyor belt is set to zero; forage is picked up by the pick-up and remains on the stationary conveyor belt.

Centre drive for compact side mounting of the pick-up

Thanks to the centre drive of the pick-up, the side take-up devices are extremely narrow. Having a pick-up with a front face that is as small as possible improves the flow of forage, particularly in silage applications.



Safe transportation

Suitable crane and lashing eyes for maintenance and repair work are integrated in the structure and make safe transportation possible.



Robust chassis

The stable feeler rollers have a wide contact surface. The arrangement as double rollers improves the depth control.

Attachment grille



If large quantities of forage need to be moved, the optional attachment grille can be fitted to the rear panel. The tubular design gives you an ideal view towards the front.



Multi-Twister

Overview of types and compatibility

WALK-BEHIND TRACTOR MODEL			REX	MONDO	SWISS	MONTA M141	MONTA S141	MONTA M161	MONTA S161	VAREA M141	VAREA S141	VAREA M161	VAREA S161	VAREA M231	VAREA S231	ORBITO
Attachment name	Art. no.															
Multi-Twister 220	1644		-	-	-	-	-	•	•	-	-	-	-	•	•	•
Multi-Twister 190	1643		-	-	-	•	•	•	•	-	-	-	-	•	•	•
Optionen																
Side parts M220/190	283040		-	-	-	•	•	•	•	-	-	-	-	•	•	•
Attachment grille MT220	282880		-	-	-	•	•	•	•	-	-	-	-	•	•	•
Attachment grille MT190	283060		-	-	-	•	•	•	•	-	-	-	-	•	•	•
Roller hold-down device MT220	283050		-	-	-	-	-	•	•	-	-	-	-	•	•	•

NEW!



Limited amounts of forage can be transported uphill.



The result: Pick-up without residue and active side discharge

Rapid

Eco-Mulcher

straightforward, robust
and efficient, for all kinds of
green area

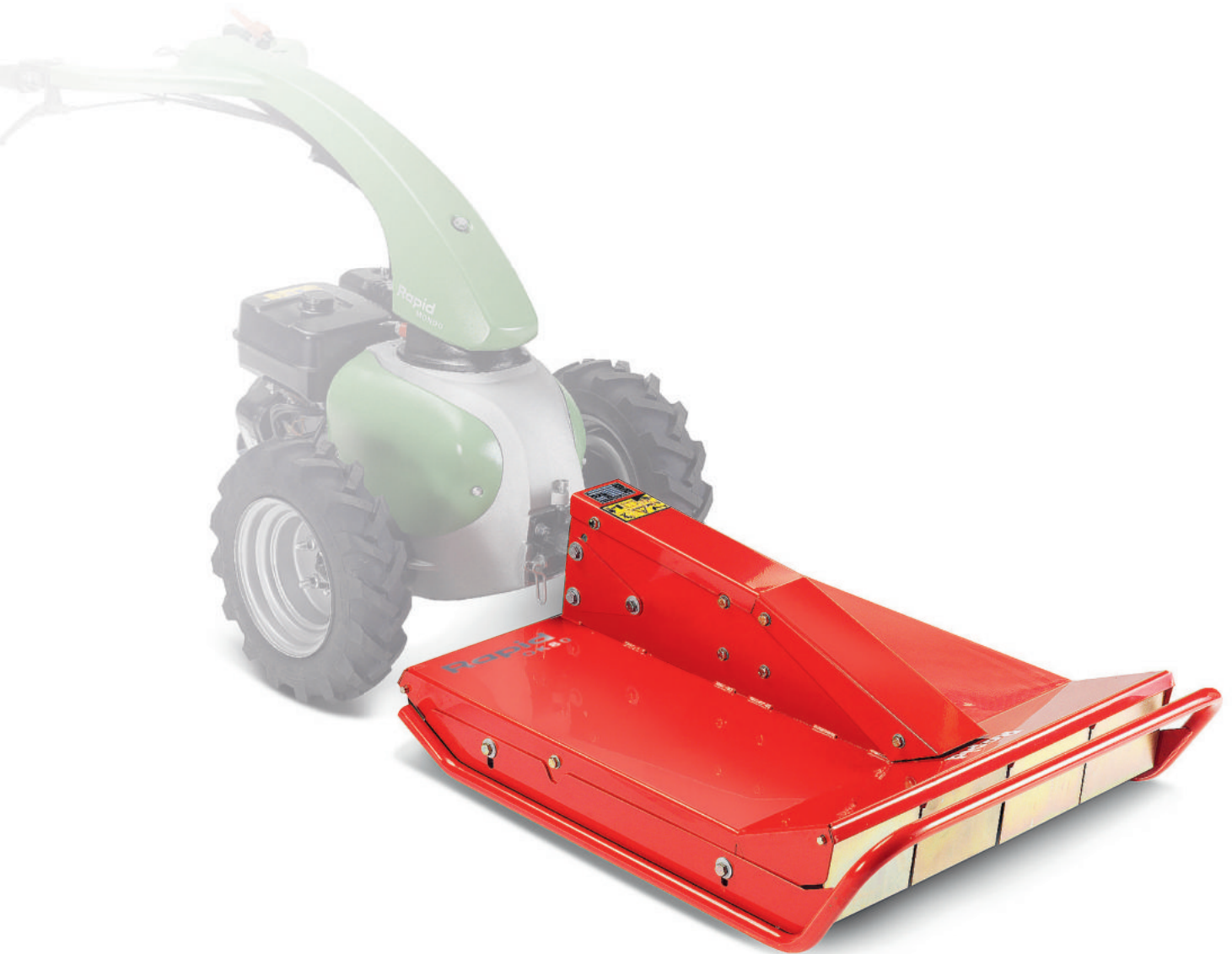

- Mowing technology
- Forage harvesting
- Mulching technology
- Cleaning
- Tilling
- Winter services
- Transport
- Special applications



Hard-wearing Eco-Mulcher for efficient maintenance of all kinds of green area



Rapid Eco-Mulchers are absolutely perfect for mulching applications involving undergrowth and green areas. The solid steel blades, which rotate horizontally, offer very high cutting performance. The finely mulched cut material is generally left lying on the ground. This method means that all kinds of green areas can be maintained quickly, leaving them neat and tidy.

OVERVIEW OF MODELS AND FEATURES

Type	1477 Rapid	1475 Rapid	1775 Rapid
Working width	70 cm	80 cm	80 cm
Height adjustment	Continuous 35–65 mm	Continuous 27-57 mm	Continuous 27-57 mm
No. of blades	2	2	2
Machine guidance method	On skids	On skids	On skids
Ejection	Rear	Rear	Rear
Weight	58 kg	67 kg	77 kg
Connection flange	52/54 mm	52/54 mm	78/80 mm



Carry out work comfortably and efficiently



Rapid Eco-Mulchers offer an easy way to care for green areas where extensive cultivation techniques are used. The walk-behind tractors feature a hydrostatic travel drive and so the machines can be guided easily and comfortably.

Compared with trimmers, Eco-Mulchers offer much better acreage performance and ensure an even looking cut. This will not only keep machine operators happy, but also land owners and passers-by.



The keys to success

- Optimum cutting and chopping quality even when tackling tall grass or undergrowth
- Cut material is deposited neatly
- Continuously adjustable cutter height
- Robust and durable for daily use by professionals
- Compact and low-maintenance
- Neat cutting and much higher efficiency compared with trimmers

Good news for nature – in more ways than one



The blades of the Rapid Eco-Mulcher are set at a defined distance from the ground.

Compared with other mulching methods with no defined cutter height, this provides better protection for small animals.

What's more, the drive for the horizontally rotating mulching blades uses relatively little energy. This results in low levels of fuel consumption in relation to overall acreage performance, which is positive for the environment and in terms of operating costs.



How the Eco-Mulcher works

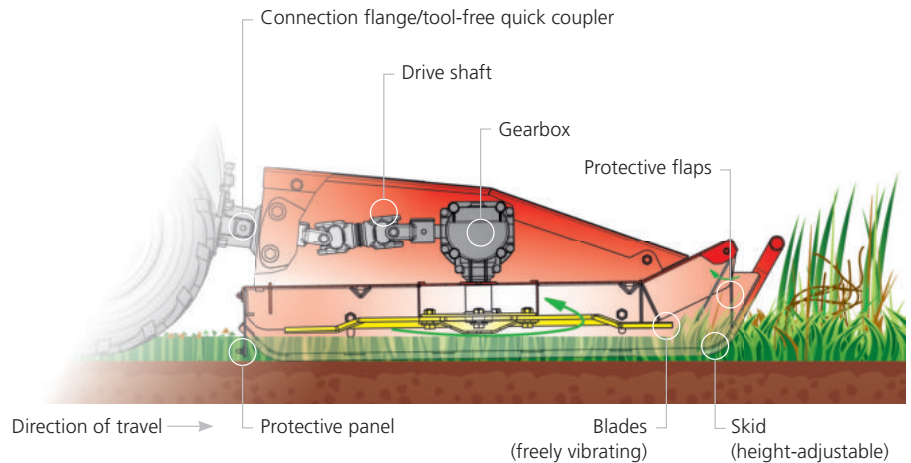

Mulching makes good ecological sense



Mulching can be used to keep open green areas free from shrubs.

When it's a question of maintaining road traffic islands or embankments, the benefits of the Rapid machine combination are clear: total efficiency for neatly cut and visually attractive green areas. And there is no need for chemicals, which is great news for the environment.

User-friendliness

Rapid Eco-Mulchers are very user-friendly. Thanks to the tool-free quick coupler, the attachments can be coupled to the walk-behind tractor in a matter of seconds. The strength of the appliance combination lies in its intuitive functions.



No need for tidying up



The continuously variable travel drive used on Rapid walk-behind tractors practically eliminates the need for manual tidying up. This is because the implement is capable of approaching obstacles easily with millimetre precision and without having to uncouple. Thanks to the flexible range of tyre options for the walk-behind tractor, mulching can be carried out safely, efficiently and neatly even on steep embankments.



Sturdy, 8 mm thick steel blades

Optimum conservation for grazing land

Eco-Mulchers are ideal for mulching on grazing land. Any grass and undergrowth that hasn't been grazed by the animals is cut and finely chopped. This encourages even growth and results in high-quality forage.



What professionals like about Rapid machines is their quality, efficiency, sturdiness and durability. The low maintenance and service costs incurred over many hours of operation mean that Rapid Eco-Mulchers are the perfect implements for everyday use when it comes to cost-effectiveness as well.

Eco-Mulcher

Overview of types and compatibility

WALK-BEHIND TRACTOR MODEL			REX	MONDO	SWISS	MONTA M141	MONTA S141	MONTA M161	MONTA S161	VAREA M141	VAREA S141	VAREA M161	VAREA S161	VAREA M231	VAREA S231	ORBITO
Attachment name	Art. No.															
Eco-Mulcher 70 cm	1477		•	-	-	-	-	-	-	-	-	-	-	-	-	-
Eco-Mulcher 80 cm	1475		-	•	-	-	-	-	-	-	-	-	-	-	-	-
Eco-Mulcher 80 cm	1775		-	-	•	•	•	•	•	•	•	•	•	•	•	-

All kinds of applications



Rapid Eco-Mulchers can be used to carry out various types of work efficiently.

The key areas of application are:

- Garden and landscape management
- Agriculture and viticulture
- Local authority services
- Road maintenance



The result: finely chopped mulch



Rapid

Flail Mower

the powerful and efficient solution for tackling undergrowth and green areas



- Mowing technology
- Forage harvesting
- Mulching technology
- Cleaning
- Tilling
- Winter services
- Transport
- Special applications



Robust Flail Mowers for efficient conservation and management of green areas



Rapid Flail Mowers cut through grass and seedlings, leaving behind finely chopped mulch. The Y blades, which are mounted on the balanced driving shaft so that they are free to move, are extremely hard-wearing and enable you to work efficiently with hardly any vibrations. This results in a clean cut and perfectly maintained green areas.



OVERVIEW OF MODELS AND FEATURES

Type	1709 Rapid	1571 Rapid	1710 Rapid	1572 Rapid	1711 Rapid	1573 Rapid	1712 Rapid	1574 Rapid
Working width	68 cm	70 cm	70 cm	90 cm	90 cm	110 cm	110 cm	130 cm
Total width	78 cm	75 cm	75 cm	95 cm	95 cm	115 cm	115 cm	135 cm
Cutter height	10 – 100 mm	20 – 100 mm	20 – 100 mm	20 – 100 mm	20 – 100 mm	20 – 100 mm	20 – 100 mm	20 – 100 mm
No. of blade pairs	16	18	18	24	24	30	30	36
Weight	77 kg	110 kg	110 kg	140 kg	140 kg	156 kg	156 kg	172 kg
Connection flange (mm)	52/54	78/80	78/80	78/80	78/80	78/80	78/80	78/80

Carry out work comfortably and safely

Rapid Flail Mowers are designed to be extremely robust. That goes for the drive, the enclosure and the coupling components alike. The solid blade driving shaft is beautifully balanced. This keeps vibrations to a minimum and ensures maximum comfort. Together, the Rapid Flail Mower and Rapid Flail Mower and Rapid walk-behind tractor form the perfect unit. As a result, even hard tasks can be completed in absolute comfort and safety.

The keys to success

- Extremely high cutting performance even when tackling tough grass and undergrowth
- Easy and continuous height adjustment
- Extremely narrow drive box means you can get really close to obstacles
- Feeler roller cleans itself during operation thanks to the closely spaced blades
- Minimal vibrations thanks to the balanced blade driving shaft
- Machine brake ensures safety by bringing the machine to a stop within seconds if you let go of the dead man handle or in the event of decoupling

Maximum cutting performance with minimal maintenance



The functional principle of the Flail Mower is based on a rotating shaft that is equipped with blades that are free to move. These blades cut through and chop up grass and undergrowth. The patented **ESM-Y** blades used on Rapid Flail Mowers are heavy duty. Their extremely high cutting performance and resilience make them really stand out. Consequently, they can be used day after day to carry out work efficiently with a minimum of maintenance but maximum endurance.

How the Flail Mower works

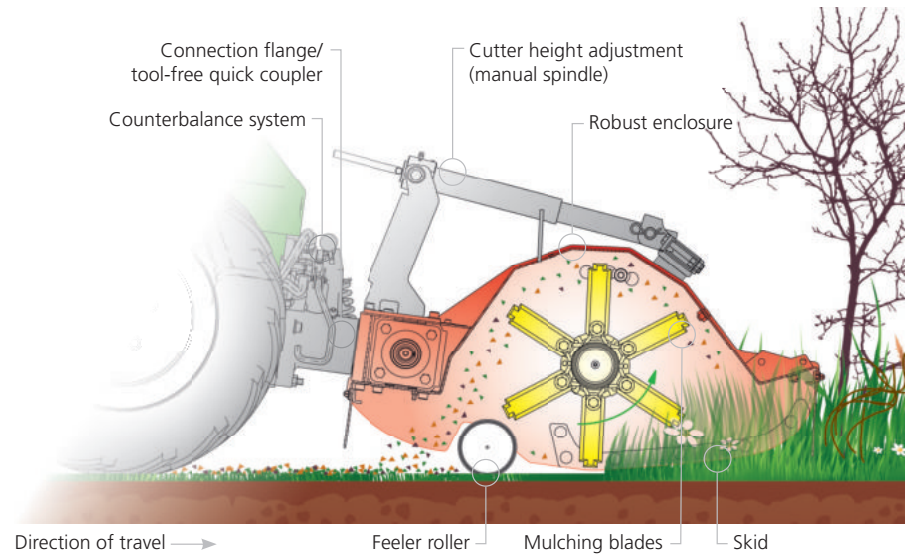

Machine combination is easy to guide



Despite the solid design of the Rapid Flail Mowers, users can manoeuvre them easily and precisely. The intuitive Rapid rotary grip allows continuously variable forward and reverse travel and enables you to approach obstacles "with millimetre precision". When walk-behind tractors with active steering are coupled to the Flail Mower and exactly the right tyres are selected for the conditions, the machine combination can be steered effortlessly even under the most challenging of circumstances.

Mulching makes good ecological sense



Mulching is the easy way to keep open green areas free from shrubs.

When it's a question of maintaining road traffic islands or embankments, the benefits of the Rapid machine combination are clear: total efficiency for neatly cut and visually attractive green areas. And there is not even any need for chemicals, which is great news for the environment.

Optimum conservation for grazing land

Flail Mowers are ideal for mulching on grazing land. Any grass and undergrowth that hasn't been eaten by the animals is cut and finely chopped. This encourages even growth and results in high-quality forage.

Rapid quality pays off

What professionals like about Rapid machines is their quality, efficiency, sturdiness and durability. The low maintenance and service costs incurred over many hours of operation mean that Rapid Flail Mowers are also a force to be reckoned with in terms of value for money.



Patented ESM-Y blade pair



Flail Mower

Overview of types and compatibility

WALK-BEHIND TRACTOR MODEL			REX	MONDO	SWISS	MONTA M141	MONTA S141	MONTA M161	MONTA S161	VAREA M141	VAREA S141	VAREA M161	VAREA S161	VAREA M231	VAREA S231	ORBITO
Attachment name	Art. No.															
Flail Mower 68 cm	1709		-	•	-	-	-	-	-	•	•	•	•	•	•	-
Flail Mower 70 cm	1571		-	-	•	-	-	-	-	-	-	-	-	-	-	-
Flail Mower 70 cm	1710		-	-	•	•	•	•	-	-	-	-	-	-	-	-
Flail Mower 90 cm	1572		-	-	-	•	•	•	-	-	-	-	-	•	•	•
Flail Mower 90 cm	1711		-	-	-	-	-	-	•	•	•	•	-	-	-	-
Flail Mower 110 cm	1573		-	-	-	-	-	•	•	-	-	-	-	•	•	•
Flail Mower 110 cm	1712		-	-	-	-	-	-	-	-	-	•	•	-	-	-
Flail Mower 130 cm	1574		-	-	-	-	-	-	-	-	-	-	-	•	•	•
Optional																
Manual spindle for continuous height adjustment	281020		-	-	•	•	•	•	•	•	•	•	•	•	•	•
Counterbalance system to counter attachment weight	257410		-	-	•	-	-	-	-	-	-	-	-	-	-	-
Counterbalance system to counter attachment weight	266452		-	-	-	•	•	•	•	•	•	•	•	•	•	•
Hydraulic actuation for continuous height adjustment	281019		-	-	-	-	-	-	-	•	•	•	•	•	•	•

All kinds of applications



Rapid Flail Mowers can be used to carry out various types of work efficiently.

The key areas of application are:

- Garden and landscape management
- Agriculture and viticulture
- Local authority services
- Road maintenance

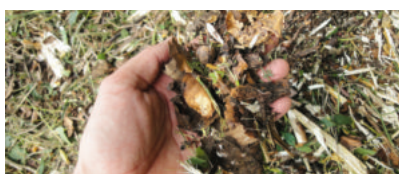

The result: finely chopped cut material



Rapid

Rotary tiller

straightforward and robust design, loosens any soil



- Mowing technology
- Forage harvesting
- Mulching technology
- Cleaning
- Tilling**
- Winter services
- Transport
- Special applications



The selectable rotary tilling direction means that even hard ground can be loosened easily and efficiently



The Rapid rotary tiller breaks up clods of earth and finely tills the ground so it is ready for cultivation. What is really impressive about the ingeniously straightforward and robust design is that it allows you to set the rotary tilling direction so that it runs opposite to the direction of travel. This makes it much easier to guide the implements when working on hard ground.



OVERVIEW OF MODELS AND FEATURES

Type	1465 Rapid	1464 Rapid
Working width	70 cm	90 cm
No. of blade pairs	10	10
Hood	Can be opened without tools	Can be opened without tools
Rotary tilling direction	Selectable	Selectable
Weight	55 kg	79 kg
Connection flange	52/54 mm	78/80 mm



Quickly prepare the ground for sowing or planting

The blades, which are attached to the rotary tilling shaft, are angled at the outer end and open up the soil. The blades cut through earth, hard clods and root infested soil, which they then throw against the cover plate. This loosens, crumbles and mixes the ground. As a result, more oxygen gets into the ground and organic matter decomposes more quickly. In this way, the ground can be prepared for sowing or planting quickly and in a single operation.



The keys to success

- Ingeniously straightforward, robust and compact design
- Selectable rotary tilling direction
- The rotary cutter moves in of its own accord even when working on hard ground because the blades rotate opposite to the direction of travel
- Easy cleaning and maintenance thanks to tool-free hood opening
- Easy access via narrow garden paths, steep embankments, steps etc.

Low maintenance combined with high durability



The Rapid rotary tiller, which is designed for professionals, leaves nothing to be desired in terms of maintenance. The straightforward design and fact that all the components are extremely robust keep maintenance work to a minimum. So even if the equipment is put through its paces day after day, it will still last. This is particularly appreciated by both professionals and ambitious amateur gardeners alike and means their money ends up going further in the long run.



How the rotary tiller works

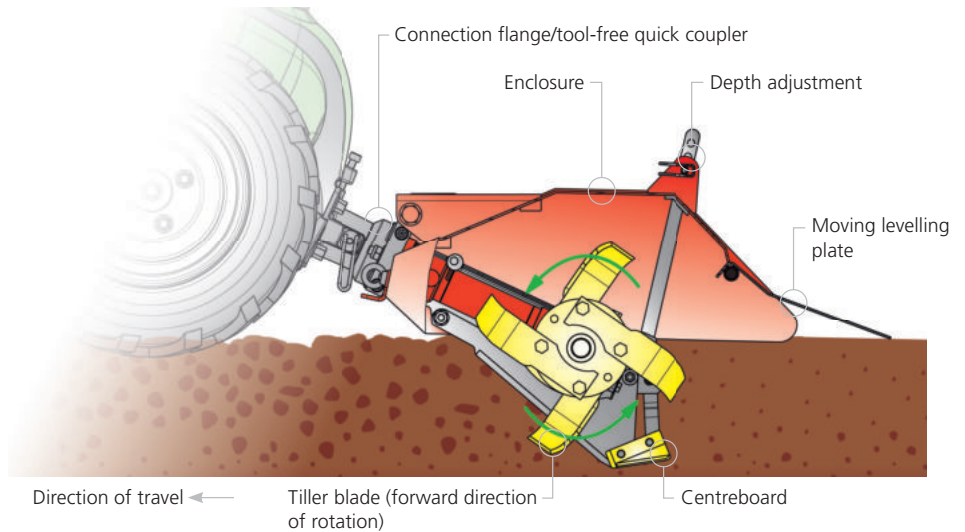

Maximum safety when working because you can change the rotary tilling direction



Conventional rotary tillers are based on the principle that the tilling shaft rotates the same way as the direction of travel. They can be used to loosen lightweight soil quite easily. However, when tilling hard or heavy soil, the equipment has a tendency to jerk forwards. This puts a lot of pressure on operators.

With the Rapid rotary tiller, you can set the rotary tilling direction so that it runs opposite to the direction of travel in just a few easy hand movements. The opposing forces cancel each other out, thereby eliminating the forward jerk effect. As a result, the equipment can be guided more smoothly and with less exertion. This brings about massive improvements in job performance and safety.

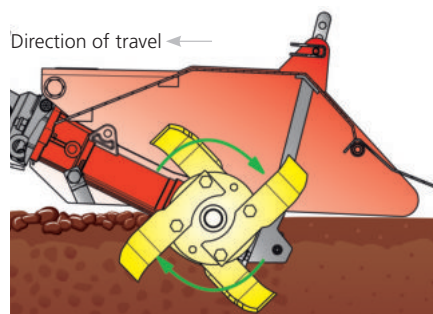

Rotary tilling direction running opposite to the direction of travel

Ergonomic working thanks to handlebar adjustment



Because you can adjust the handlebar, the Rapid walk-behind tractor system and Rapid rotary tillers are an unbeatable combination. The handlebars can be rotated 230°, which means you can fix them at an angle directly behind the machine as well as to the left or right of the furrow. As a result, you can walk safely next to the machine without leaving any unattractive footprints behind. You can even guide the appliance along the edge of obstacles (such as walls) without any problems whatsoever. The height adjustment feature (also tool-free) allows you to adjust the appliance quickly and easily according to the size of the operator or to suit the topographical conditions. Consequently, you can work ergonomically and efficiently whatever the situation.



Laterally adjusted handlebar



Tool-free hood opening

The hood of the rotary tiller can be opened without tools and tipped forwards. This provides quick access to the tilling shaft. If twine, fleece or even large stones have become caught in the tilling shaft, they can be cleared off easily in next to no time. This avoids unnecessarily long interruptions and increases acreage performance.

Rotary tiller

Overview of types and compatibility

WALK-BEHIND TRACTOR MODEL		REX	MONDO	SWISS	MONTA M141	MONTA S141	MONTA M161	MONTA S161	VAREA M141	VAREA S141	VAREA M161	VAREA S161	VAREA M231	VAREA S231	ORBITO
Attachment	Art. No.														
Rotary tiller 70 cm, Rapid	1465	-	•	-	-	-	-	-	-	-	-	-	-	-	-
Rotary tiller 90 cm, Rapid	1464	-	-	-	-	-	-	-	•	-	•	-	•	-	-

All kinds of applications



Rapid rotary tillers can be used to carry out various types of work efficiently.

The main areas of application are:

- Horticulture
- Vegetable gardening
- Fruit-growing
- Landscape gardening
- Household gardening



The result: a fine tilth ready for growing crops



Rapid

Stone buriers

buries stones and
creates a fine tilth



- Mowing technology
- Forage harvesting
- Mulching technology
- Cleaning
- Tilling**
- Winter services
- Transport
- Special applications



The high-quality stone burier prepares the ground perfectly for sowing or planting in the twinkling of an eye



The stone burier works unwanted grass, plant remains and stones down into the ground. The fine topsoil is achieved in just one operation. There is no need to go around collecting stones, which results in impressive time savings during tilling.



OVERVIEW OF MODELS AND FEATURES

Type	1512 Lipco	1519 Lipco
Working width	70 cm	90 cm
Working depth	Continuously adjustable up to max. 12 cm	Continuously adjustable up to max. 14 cm
Drive	Lateral drive	Lateral drive
Mesh roller	Laterally adjustable	Laterally adjustable
Load-limiting device	Yes	Yes
Weight	100 kg	170 kg
Connection flange	52/54 mm	78/80 mm

The keys to success

- Unwanted grass, coarse plant remains and stones get worked into the ground, leaving finely tilled earth on the surface
- The ground can be prepared for sowing or planting in a single operation
- Entire width gets worked from end to end thanks to the lateral drive
- Continuously adjustable working depth
- Low weight (compared with tractors) protects the ground
- Also ideal for use in tunnels or greenhouses
- Small appliance widths to enable access through narrow gates and via the tiniest tracks

Ready for sowing in a single operation



The robust tine pairs, which rotate the opposite way to the direction of travel, finely till the ground. Unwanted grass, plant remains and stones are thrown against a grid and worked downwards into the ground. At the same time, the finely tilled soil is deposited on the surface. The mesh roller makes sure that the surface is gently consolidated and finely textured. In this way, green areas, fields or even newly designed garden environments can be perfectly prepared for sowing and planting in a single operation.



Work in unwanted grass in a single operation

How the stone burier works

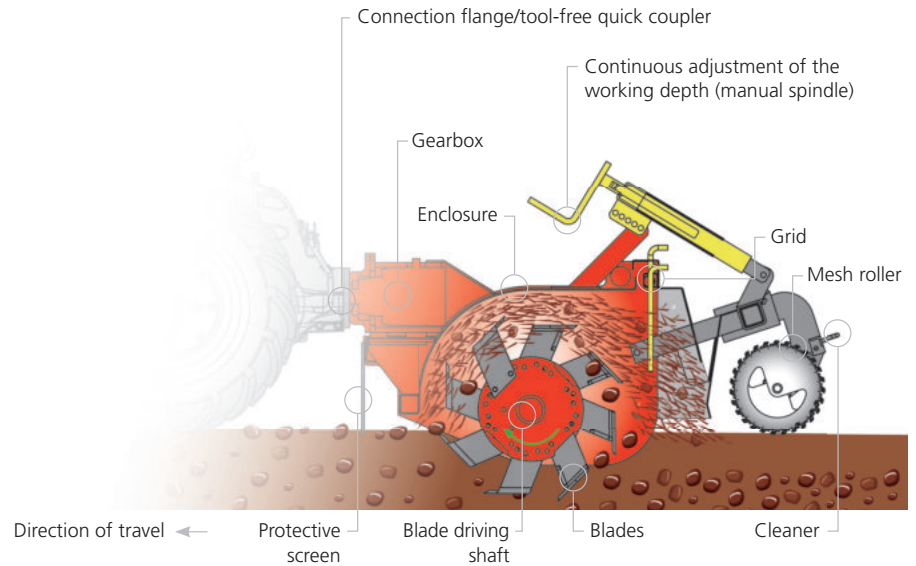

Complete width worked effectively



The advantage of the stone burier's lateral drive is that the ground can even be tilled effectively in the centre. The laterally attached drive stands out thanks to its compact design and automatic chain tensioning feature. The advantage of the laterally adjustable mesh roller is that you can get very close to the edge of curbs and walls etc.

Perform hard tasks effortlessly

Despite the weight, the Rapid walk-behind tractor with active steering can be manoeuvred effortlessly when combined with the stone burier. The continuously variable travel drive makes it easy to work the soil with millimetre precision. With Rapid, energy-sapping work becomes a thing of the past.



Easy continuous adjustment of the working depth

The working depth is set by adjusting the mesh roller. The manual spindle makes it really easy to adjust on a continuous scale.



Manual spindle for continuously adjustable tilling depth

Massive time savings

Because Rapid appliance combinations are so easy to manoeuvre with absolute precision, manual work is kept to an absolute minimum even on small areas with lots of nooks and crannies. As a result, they can be used to prepare the ground perfectly and in next to no time, creating a fine tilth in even the smallest corners.



Robust blade driving shaft

Low-maintenance and durable

The stone burier, which is designed for professionals, leaves nothing to be desired in terms of maintenance, either. All the components are extremely robust with a view to minimising maintenance work. This makes the equipment highly durable. It makes work fun without breaking the bank!

Stone buriers

Overview of types and compatibility

WALK-BEHIND TRACTOR MODEL			REX	MONDO	SWISS	MONTA M141	MONTA S141	MONTA M161	MONTA S161	VAREA M141	VAREA S141	VAREA M161	VAREA S161	VAREA M231	VAREA S231	ORBITO
Attachment name	Art. No.															
Stone burier 70 cm	1512		-	•	-	-	-	-	-	-	-	-	-	-	-	-
Stone burier 90 cm	1519		-	-	-	-	-	-	•	•	•	•	•	•	•	•
Optional																
Hydraulic lifting device for type 1519	1518		-	-	-	-	-	-	•	•	•	•	•	•	•	•

Main areas of application



Rapid machine unit combinations involving a stone burier can be used to carry out various types of work efficiently.

The main areas of application are:

- Horticulture and landscape gardening
- Vegetable gardening
- Fruit-growing
- Agriculture



The result: a fine tilth for growing crops created in a single operation

Rapid

Uni-Rotary Harrow

breaks up clods of earth, levels and loosens the ground



- Mowing technology
- Forage harvesting
- Mulching technology
- Cleaning
- Tilling**
- Winter services
- Transport
- Special applications



The Uni-Rotary Harrow breaks up clods of earth efficiently and levels and loosens the ground



The Uni-Rotary Harrow breaks up clods of earth effectively, while at the same time loosening, oxygenating and finely levelling the soil. Thanks to the large number of rotary tines, fine results can be achieved in a single operation. This provides the perfect basis for growing all kinds of plants, vegetables or turf successfully.



OVERVIEW OF MODELS AND FEATURES

Type	1341 R2	8342 R2	1440 R2
Working width	75 cm	100 cm	125 cm
Working depth	0–15 cm, continuously adjustable	0–15 cm, continuously adjustable	0–15 cm, continuously adjustable
Number of rotary tine pairs	5	7	7
Mesh roller	Yes	Yes	Yes
Dozer blade	Yes	Yes	Yes
Drilling container volume (optional)	37 l	44 l	-
Weight	95 kg	115 kg	145 kg
Connection flange	52/54 mm	78/80 mm	78/80 mm

The keys to success

- Till, level and (optionally) sow in a single operation
- Optional drilling container with automatically measured seed delivery
- Working depth can be continuously adjusted via mesh roller
- Machine combination is extremely manoeuvrable
- Also ideal for use on embankments, in tunnels or greenhouses
- Compact and low-maintenance
- Low weight (compared with tractors) protects the ground
- Small machine widths to enable access through narrow gates and via the tiniest tracks and steps

Till, level and sow in a single operation

 Numerous robust tine pairs rotate horizontally and finely till the ground. The height-adjustable mesh roller and dozer blade can level out bumps and hollows perfectly. While it is being worked, the finely tilled ground is provided with more oxygen so that organic matter decomposes more quickly and to create the optimum conditions for rapid growth. The optionally available drilling container can be mounted directly on the Uni-Rotary Harrow. In this way, green areas, fields and even newly created garden environments can be perfectly loosened, levelled and sown in a single operation.



Uni-Rotary Harrow with drilling container

How the Uni-Rotary Harrow works

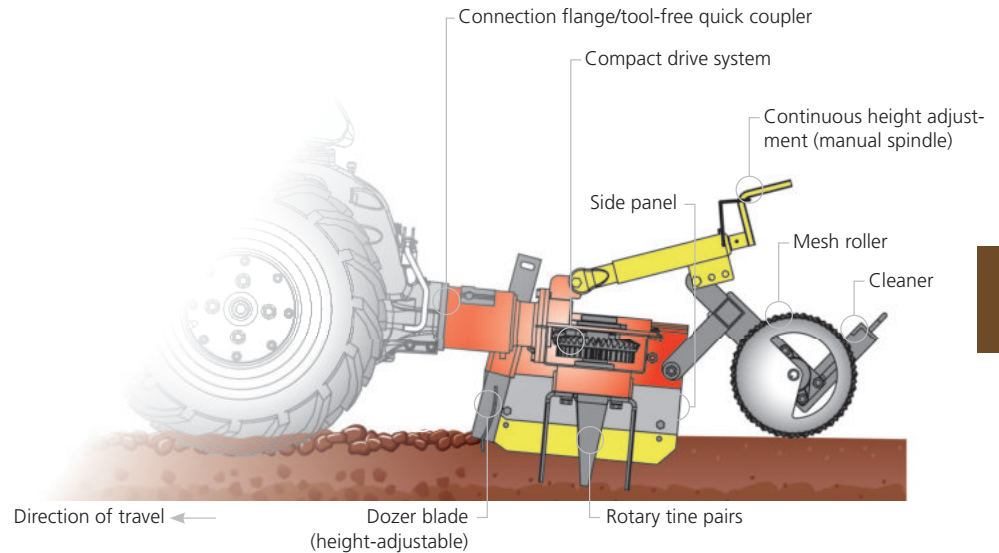

Enormous time savings



With the Uni-Rotary Harrow you can even work hard ground and also newly created environments.

While the rotary tine pairs are busy loosening the ground, during the same operation, the dozer blade is finely levelling the ground and the mesh roller is consolidating the soil. This makes it much easier to carry out horticultural and landscape gardening tasks as well as any other work that involves sowing on a grand scale. The result is maximum acreage performance.

Efficiency thanks to easy handling

Rapid machine combinations are easy and safe to operate. The continuously variable travel drive and active steering systems make physical work much easier while at the same time increasing efficiency.



Rapid machines are easy to operate

Continuous adjustment of the working depth



The working depth is determined by the mesh roller. This can easily be adjusted on a continuous scale using the manual spindle.



Working depth can be continuously adjusted using the manual spindle

Work next to obstacles without the slightest difficulty

The compact drive system is located above the rotary tine pairs. Consequently, the Uni-Rotary Harrow can be used right next to the edges of walls, curbs or other obstacles without any problem at all. This does away with the need for strenuous manual work afterwards.



Work right up to the edge of obstacles without any problems

Low maintenance combined with high durability

The robust Uni-Rotary Harrows, which are designed for professionals, leave nothing to be desired in terms of maintenance. Minimum maintenance plus high durability will make sure you enjoy your work day after day and help your money go further.

Uni-Rotary Harrow

Overview of types and compatibility

WALK-BEHIND TRACTOR MODEL			REX	MONDO	SWISS	MONTA M141	MONTA S141	MONTA M161	MONTA S161	VAREA M141	VAREA S141	VAREA M161	VAREA S161	VAREA M231	VAREA S231	ORBITO
Attachment name	Art. No.															
Uni-Rotary Harrow 75 cm	1341		-	•	-	-	-	-	-	-	-	-	-	-	-	-
Uni-Rotary Harrow 100 cm	8342		-	-	-	-	-	-	•	•	•	•	•	•	•	•
Uni-Rotary Harrow 125 cm	1440		-	-	-	-	-	-	-	-	-	-	-	•	•	•
Optional																
Drilling container 37 l, for Uni-Rotary Harrow 75 cm	1446		-	•	-	-	-	-	-	-	-	-	-	-	-	-
Drilling container 44 l, for Uni-Rotary Harrow 100 cm	8348		-	-	-	-	-	-	•	•	•	•	•	•	•	•
Hydraulic operation for Uni-Rotary Harrow 100 cm	8913		-	-	-	-	-	-	•	•	•	•	•	•	•	•

All kinds of applications



Uni-Rotary Harrows can be used to carry out various types of work efficiently.

The key areas of application are:

- Horticulture and landscape gardening
- Vegetable gardening
- Nurseries



The result: levelled and finely loosened ground with a compacted layer of top soil

Rapid

Snowploughs

ready for operation in a flash,
user-friendly, robust and safe



- Mowing technology
- Forage harvesting
- Mulching technology
- Cleaning
- Tilling
- Winter services**
- Transport
- Special applications



User-friendly snowploughs for clearing small-to-medium quantities of snow efficiently and with neat and tidy results



Rapid snowploughs really stand out thanks to their versatility, safety and ease of use. The pivoting mechanism, which can be conveniently operated from the handlebar, offers an efficient method of pushing snow out of the way in the desired direction. Thanks to the side panels (mounted without tools), areas of a considerable size can be cleared without leaving any snow behind.



OVERVIEW OF MODELS AND FEATURES

Type	281945 Rapid snowplough	281946 Rapid snowplough	281947 Rapid snowplough
Snowplough width	100 cm	125 cm	150 cm
Working widths	81-100 cm	101-125 cm	121-150 cm
Snowplough height	49 cm	49 cm	49 cm
Sprung tilt mechanism	Yes	Yes	Yes
No of pivoting positions	5	5	5
Pivoting angle	0°, 18°, 36°	0°, 18°, 36°	0°, 18°, 36°
Adjustable slip heels	Yes	Yes	Yes
Adjustable guide roller	Optional	Optional	Optional
Side panel	Optional	Optional	Optional
Vulkolan bar	Optional	Optional	Optional
Weight	67 kg	79 kg	90 kg

The keys to success

- Spring-back tilt mechanism for impact-free work and protection of the machine and environment
- Easy to operate, can be swivelled from the handlebar
- Robust design, interchangeable scraper bars and slip heels
- Sophisticated plough geometry means that large quantities of snow can be efficiently moved to the side thanks to the "rolling effect"
- Optional vulkolan bar for clearing surfaces that are vulnerable to impacts and scratches without causing damage

Ready for action in a flash



Rapid machines are ready for action in next to no time. All it takes to couple the snowplough to the base machine is a few easy hand movements. No tools are required and you are ready to start clearing snow right away. Even after the machines have been out of action during the warmer seasons, you can still start work immediately because they are so straightforward.

Neat and tidy clearance even when the snow is hard

The Combi-carrying arm, which is provided as standard, allows you to make a short or a long setting. This changes the pressure exerted by the snowplough blade, enabling neat and tidy clearance whether the snow is soft or hard.

Areas that have been cleared using Rapid snowploughs ensure maximum safety for pedestrians and drivers.

How the snowplough works

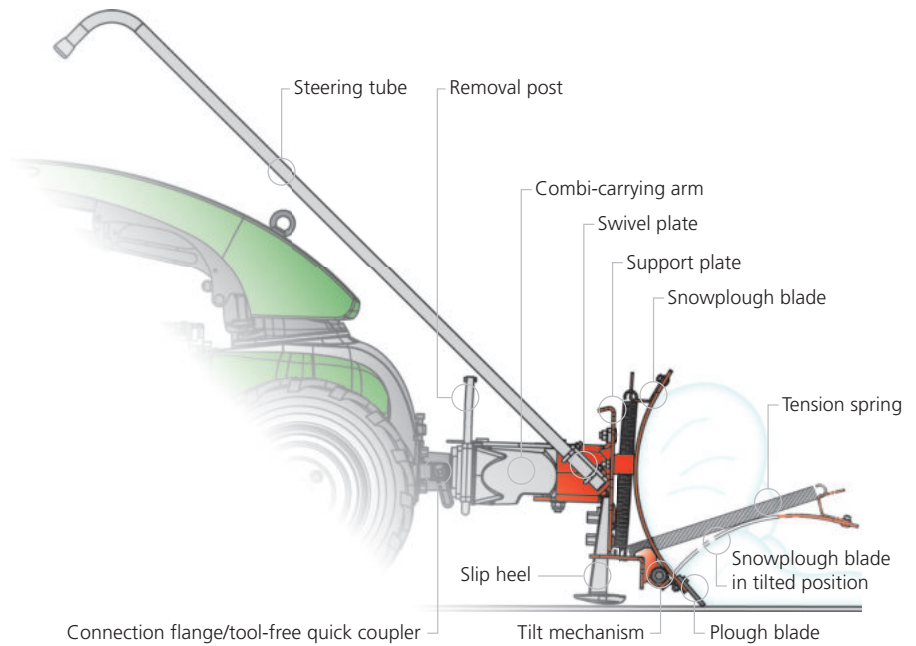

Maximum security for users thanks to the spring-back tilt mechanism



All Rapid snowploughs feature a sprung tilt mechanism. If the user hits an obstacle (such as a curbstone), the snowplough tips forward briefly so that the machine can travel over the obstacle. This prevents the machine combination from coming to an abrupt stop. In turn, this also protects the operator, the machine and the environment against impacts.

Snow chains to increase the traction

With a view to increasing safety and job performance, the use of snow chains is recommended. Suitable power or track chains are available for the various tyre types.



Versatile and efficient



The desired clearance height can be set using the slip heels or optional rollers. The snowploughs can be adjusted laterally from the handlebar, allowing them to be swivelled into five different positions.

So that large public open spaces can be cleared efficiently, you also have the option of using side panels. These prevent the snow from spilling out over the snowplough at the sides. In addition, even large quantities of snow can be shovelled across long distances in the direction of travel.

Clear delicate surfaces without causing damage



If the surfaces you want to clear are vulnerable to impacts or scratches it is best to work with vulkolan bars. These optional scraper bars are softer than their steel counterparts, which means they help protect surfaces without leaving the slightest trace of a scratch.



Vulkolan bar



Even better performance and comfort when clearing large quantities of snow thanks to the side panels.

Snowploughs

Overview of types and compatibility

WALK-BEHIND TRACTOR MODEL			REX	MONDO	SWISS	MONTA M141	MONTA S141	MONTA M161	MONTA S161	VAREA M141	VAREA S141	VAREA M161	VAREA S161	VAREA M231	VAREA S231	ORBITO
Attachment name	Art. No.															
Snowplough 100 cm	281945		•	•	•	-	-	-	-	-	-	-	-	-	-	-
Snowplough 125 cm	281946		-	•	•	•	•	•	•	•	•	•	•	•	•	•
Snowplough 150 cm	281947		-	-	-	-	-	•	•	-	-	•	•	•	•	•
Obligatory																
Carrying arm	260812		•	-	-	-	-	-	-	-	-	-	-	-	-	-
Combi-carrying arm	260810		-	•	•	•	•	•	•	•	•	•	•	•	•	•
Optional																
Side panels (pair)	281952		•	•	•	•	•	•	•	•	•	•	•	•	•	•
Guide rollers (pair)	1420		•	•	•	•	•	•	•	•	•	•	•	•	•	•
Ballast weight 8.5 kg	259686		•	•	•	-	-	-	-	•	•	•	•	•	•	•
Hydraulic pivoting mechanism	1559		-	-	-	-	-	-	-	•	•	•	•	•	•	•
Vulkolan bar 100 cm	1541		•	•	•	-	-	-	-	-	-	-	-	-	-	-
Vulkolan bar 125 cm	4823		-	•	•	•	•	•	•	•	•	•	•	•	•	•
Vulkolan bar 150 cm	4824		-	-	-	-	-	•	•	-	-	•	•	•	•	•

All kinds of applications



Rapid snowploughs can be used to carry out various types of work efficiently.

The key areas of application are:

- Driveways (homes and hotels) and farm access roads
- Forecourts
- Footpaths
- Underpasses
- Small bridges
- Narrow public open spaces and those with lots of nooks and crannies



The result: safety achieved through a professional approach to snow clearance

Rapid

Snow throwers

masters of deep snow, user-friendly, robust and efficient



- Mowing technology
- Forage harvesting
- Mulching technology
- Cleaning
- Tilling
- Winter services
- Transport
- Special applications



User-friendly, safe and robust snow throwers for clearing large quantities of snow with ease



Rapid snow throwers really stand out thanks to their safe and easy operation. They are designed to be robust and are ready for action in no time at all. They cut through snow efficiently and catapult it precisely toward the desired location. Paths and open spaces can be rapidly cleared for users to ensure safe passage.

OVERVIEW OF MODELS AND FEATURES

Type	1568 Rapid	1569 Rapid	1562 Rapid	1563 Rapid
Working width	70 cm	70 cm	87 cm	105 cm
Reel	ø 40 cm	ø 40 cm	ø 46 cm	ø 46 cm
Spinner	ø 35 cm	ø 35 cm	ø 35 cm	ø 35 cm
Safety element	Shear bolt	Shear bolt	Safety clutch	Safety clutch
Height-adjustable slip heels	Yes	Yes	Yes	Yes
Weight	94 kg	94 kg	132 kg	144 kg
Connection flange	52/54 mm	78/80 mm	78/80 mm	78/80 mm



Suitable for any type of snow



The robust Rapid snow throwers can be used to clear away various types of snow. Whether faced with a fresh layer of powdery snow or hard compacted snow that has been lying on the ground for some time and is partially frozen, you can clear it all away effortlessly with these machines. Rapid snow throwers are also extremely impressive in terms of their high output capacity. Therefore, they provide an effective means of clearing piles of snow, whatever the depth, whatever the altitude and whatever the application.

The keys to success

- Robust design with solid toothed reels enables the machine to cut through snow efficiently and easily even when the snow is hard
- Ready for action in no time at all
- Safe and convenient operation incl. ejection chamber adjustment via the handlebar
- Very high snow output volumes
- Large snow throwing range and precision aiming thanks to the adjustable ejection chamber
- Low-maintenance, designed for durability
- Maximum ease of use and efficiency thanks to Rapid walk-behind tractors, which feature a continuously variable hydrostatic travel drive

Robust design – always ready for action

All Rapid snow throwers stand out because of their high quality, the speed with which they can be ready for action and their high durability. The solid, toothed reel cuts through the snow and guides it towards the spinner. The ejection chamber is able to throw the snow out cleanly across long distances, aiming precisely at the desired location. In the unlikely event of the snow getting stuck in the ejection chamber, the wooden push rod can be removed from the enclosure without using tools and used to clear the blockage quickly.



Robust design for tough applications and high durability

How the snow thrower works

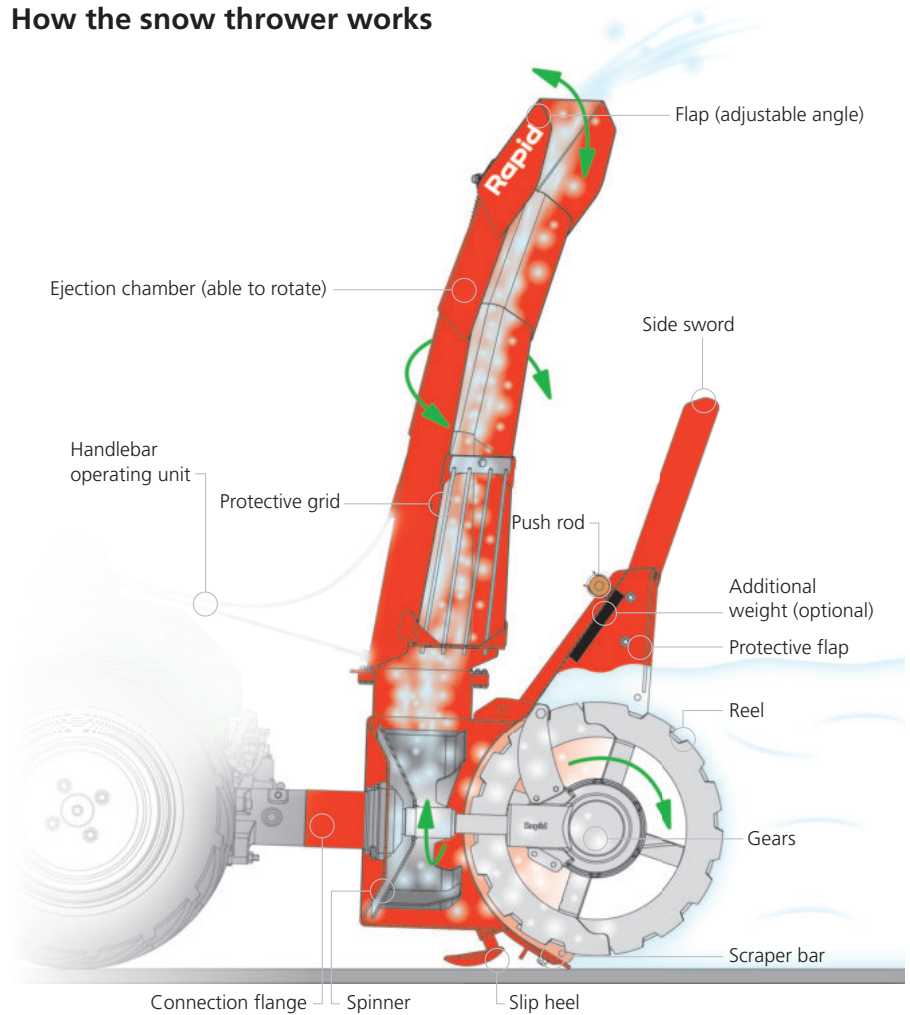

Snow chains to increase the traction

With a view to increasing safety and job performance, Rapid recommends working with snow chains. Power or track chains are available from Rapid for all models and tyre types.



Snow chains increase safety and job performance

Easy and convenient operation via the handlebar

Easy Control The snow thrower can be operated easily and safely from the operating position. Because the pivoting mechanism for the ejection chamber has such a large ratio, the target location for snow throwing can be quickly adapted whatever the situation. The throw distance can also be easily adjusted from the travel position by adjusting the height of the ejection flap. This means snow can be cleared conveniently and with ease.



Target location for snow throwing can be conveniently adjusted via the handlebar during travel

Environmental and equipment safety

Safety System All Rapid snow throwers are equipped with a safety shear bolt or a safety clutch. These safety elements are activated if the machine happens to collide with an obstacle such as a curbstone or a rock ledge. Power stops being transmitted to the snow thrower immediately, thereby preventing damage to the environment and the equipment.



Extremely high snow output volumes

Snow throwers

Overview of types and compatibility

WALK-BEHIND TRACTOR MODEL			REX	MONDO	SWISS	MONTA M141	MONTA S141	MONTA M161	MONTA S161	VAREA M141	VAREA S141	VAREA M161	VAREA S161	VAREA M231	VAREA S231	ORBITO
Attachment name	Art. No.															
Snow thrower 70 cm	1568		-	•	-	-	-	-	-	-	-	-	-	-	-	-
Snow thrower 70 cm	1569		-	-	•	-	-	-	-	•	•	•	•	-	-	-
Snow thrower 87 cm	1562		-	-	-	-	-	-	•	•	•	•	•	•	•	•
Snow thrower 105 cm	1563		-	-	-	-	-	-	-	-	-	-	-	•	•	•
Optional																
Side swords (pair)	1564		-	•	•	-	-	-	-	•	•	•	•	•	•	•
Hydraulic operation	281955		-	-	-	-	-	-	-	•	•	•	•	•	•	•
Ballast weight 8,5 kg	259686		-	•	•	-	-	-	-	•	•	•	•	•	•	•

All kinds of applications



Rapid snow throwers can be used to carry out various types of work efficiently.

The key areas of application are:

- Clearing public and private tracks, paths and open spaces
- Clearing narrow access routes
- Clearing small bridges and footbridges
- Clearing areas with lots of nooks and crannies, e.g. petrol stations.

Thanks to their low gross weight and compact dimensions, Rapid machines can easily be transported to remote locations using methods of transportation such as cable cars.



The result: safe passage after professional snow clearing

Rapid

Sweepers

easy to use, tough on dirt



- Mowing technology
- Forage harvesting
- Mulching technology
- Cleaning**
- Tilling
- Winter services
- Transport
- Special applications



Powerful systems for inviting paths and open spaces that are glistening with cleanliness in next to no time



The powerful sweepers from Rapid are extremely flexible and can be used all year round. In summer, they get to work on dust and dirt while in winter they are able to remove freshly fallen snow without a trace. You have the option of sweeping material in the direction of travel or to the side. If the dirt container is fitted, dirt can be collected as part of the same operation without any mess. Using the side brush makes child's play of cleaning right up to the edge of obstacles such as curbs.



OVERVIEW OF MODELS AND FEATURES

Type	1672	1328	1455	1673	8865
Machine width	90 cm	90 cm	110 cm	110 cm	110 cm
Working width	85 cm	85 cm	105 cm	105 cm	95 cm
Universal brush	Ø 35 cm	Ø 35 cm	Ø 35 cm	Ø 35 cm	Ø 42 cm
Can be swivelled to the side	Yes	Yes	Yes	Yes	Yes
Centre drive	Yes	Yes	Yes	Yes	Yes
Brush rotational speeds	1	1	1	1	2
Dirt container	55 l	55 l	65 l	65 l	110 l
Side brush	Ø 42 cm Total width 110 cm	Ø 42 cm Total width 110 cm	Ø 42 cm Total width 130 cm	Ø 42 cm Total width 110 cm	Ø 52 cm Total width 130 cm
Sweeper weight	40 kg	40 kg	45 kg	45 kg	86 kg
Connection flange	52/54 mm	52/54 mm	52/54 mm	78/80 mm	78/80 mm

Appealing and inviting driveways and paved areas

The sweepers can be coupled to the Rapid walk-behind tractors in no time at all using the tool-free quick coupler and are highly efficient. They can be used for professional cleaning of footpaths, forecourts, car parks and narrow paths. The result: neat and tidy driveways and paved areas that are appealing and inviting for visitors or customers.

The keys to success

- Machine combination is highly manoeuvrable
- Work can be carried out effortlessly even on slopes
- Sweep up and collect dirt in a single operation
- Practically dust-free sweeping thanks to the almost fully enclosed system
- Efficient and hard-wearing brushes
- Can be used all year round

Ready for action in no time thanks to the tool-free quick coupler



Rapid machines can be converted for a different use in next to no time. Various implements can be fitted and swapped over

quickly and conveniently using the tool-free coupling system.



Tool-free quick coupler

How the sweeper works (closed system)

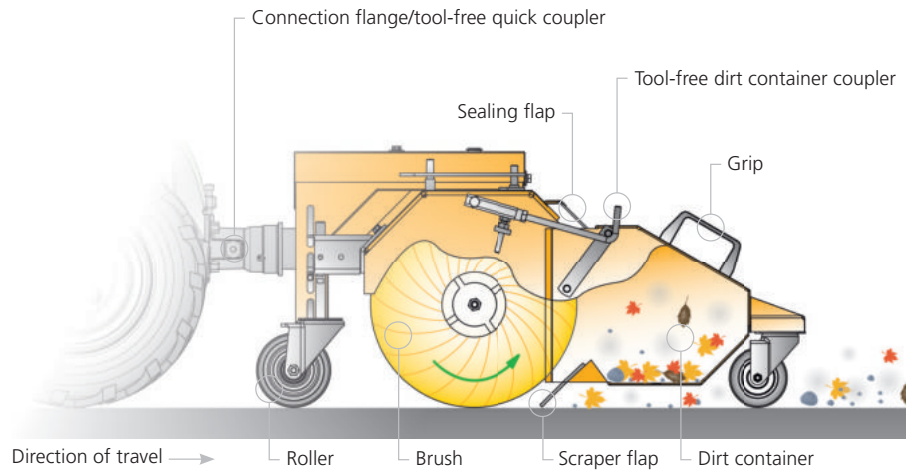

Sweeping with the open system

If the Combi-Sweeper is used without the dirt container, you have an open system which sweeps dust, dirt or snow away to the front of the machine. With the brush laterally positioned, the dirt gets swept to the side. By performing several parallel runs, this means you can even sweep fairly large open spaces without using a dirt container.



Sweeping with the open system

Sweep up and dispose of dirt with the closed system

 If you want to sweep paved areas clean and rid them almost entirely of dirt in a single operation, simply attach the optional dirt container. This container, which can be mounted without tools, features flexible rubber lips that create a unified sweeping system. The rotary brushes sweep up dust and dirt and deposit them in the container. The container can then be removed by hand, allowing you to dispose of the collected material quickly and easily.

Clean into every nook and cranny

 The optional side brush allows you to clean every last nook and cranny of paved open areas with absolute perfection. If the operator deviates slightly from the intended route along the edge of curbs and walls, the robust yet flexible side brush compensates for this by offering the necessary flexibility. The result: meticulously clean open spaces.



Side brush for complete cleanliness

Clearing snow from low-lying areas

 Open sweepers are also ideal for providing winter services in low-lying areas. They are highly efficient at clearing small quantities of dry snow without a trace and in an environmentally friendly way.

Easy-to-change brushes

 The brush is designed for high durability but it takes very little effort to replace should this prove necessary. Complete brushes are available as spare parts.

Sweepers

Overview of types and compatibility

WALK-BEHIND TRACTOR MODEL			REX	MONDO	SWISS	MONTA M141	MONTA S141	MONTA M161	MONTA S161	VAREA M141	VAREA S141	VAREA M161	VAREA S161	VAREA M231	VAREA S231	ORBITO
	Attachment name	Art. No.														
	Combi-Sweeper 90 cm	1672	•	-	-	-	-	-	-	-	-	-	-	-	-	-
	Combi-Sweeper 90 cm	1328	-	•	-	-	-	-	-	-	-	-	-	-	-	-
	Combi-Sweeper 110 cm	1455	-	•	-	-	-	-	-	-	-	-	-	-	-	-
	Combi-Sweeper 110 cm	1673	-	-	•	•	•	•	•	-	-	-	-	-	-	-
	Combi-Sweeper 110 cm	8865	-	-	-	-	-	-	-	•	•	•	•	•	•	•
	Optional															
	Dirt container 55 l, Wiedenmann	1329	•	•	-	-	-	-	-	-	-	-	-	-	-	-
	Dirt container 65 l, Wiedenmann	1456	-	•	•	•	•	•	•	-	-	-	-	-	-	-
	Dirt container 110 l, Wiedenmann	8866	-	-	-	-	-	-	-	•	•	•	•	•	•	•
	Side brush ø 42 cm, Wiedenmann	1330	•	•	•	•	•	•	•	-	-	-	-	-	-	-
	Side brush ø 52 cm, Wiedenmann	8867	-	-	-	-	-	-	-	•	•	•	•	•	•	•
	Hydraulic cylinder (for swivelling or emptying)	8904	-	-	-	-	-	-	-	•	•	•	•	•	•	•

All kinds of applications



When fitted with a sweeper, Rapid machines can be used to carry out various types of work efficiently. The key areas of application are:

Summer applications

- Sweeping footpaths, driveways, car parks and forecourts of all kinds
- Sweeping narrow bridges etc.

Winter applications

- Clearing snow from footpaths, driveways, car parks and forecourts of all kinds
- Clearing snow from narrow bridges etc.



The result: cleanliness for an appealing and inviting atmosphere

Path maintenance unit

Mechanical removal of weeds from water-bound areas



- Mowing technology
- Forage harvesting
- Mulching technology
- Cleaning
- Tilling
- Winter services
- Transport
- Special applications**



Environmentally friendly mechanical removal of weeds from crushed stone, gravel and grit areas



The path maintenance unit expediently maintains water-bound areas such as crushed stone, gravel and grit paths/spaces quickly, easily and ecologically as well as economically. Plants are uprooted by means of mechanical movements and deposited on the surface, where they can be easily removed. The topsoil structure remains undamaged thanks to the adjustable working height. Worked areas thereby exhibit a clean and maintained appearance without the use of chemical substances.



OVERVIEW OF MODELS AND FEATURES

Type	Path maintenance unit WP 90
Working width	90 cm
Weight	140 kg
Working tools	Rotating dual cutters



Success factors

- Easy and efficient removal of weeds from water-bound areas
- Purely mechanical process, no need to use any chemical substances
- Effective even on areas that are heavily covered in vegetation or have not been maintained for several years
- The infinitely adjustable depth control enables optimal working results in every situation
- A good appearance results even on hard coverings

Environmentally friendly procedure



The use of chemical herbicides is reduced thanks to the path maintenance unit. The work process is based on a purely mechanical operating principle. This type of path maintenance is therefore very environmentally friendly.



Simple orientation

The continuously variable height adjustment of the side plates results in a clean delineation of the working width. This enables a precise parallel run.



Functional principle of the path maintenance unit

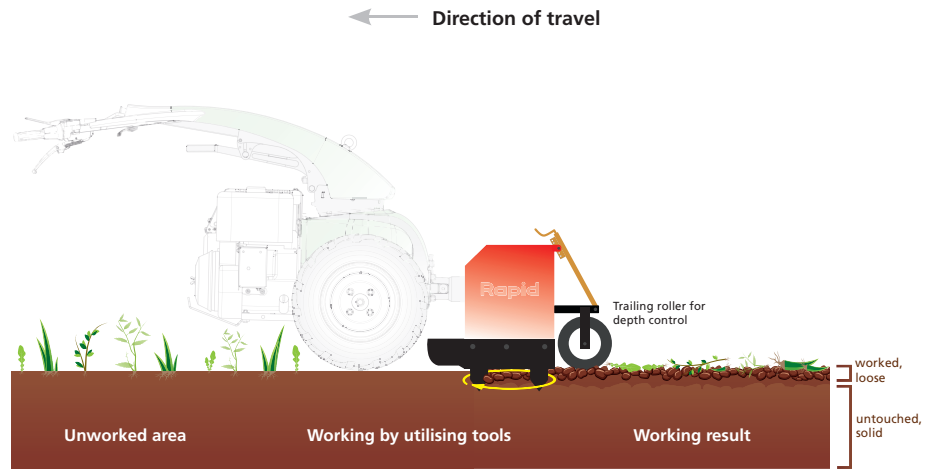

Working principle



The rotating movement of the tools uproots weeds from the ground and lays them on the surface. The tools are to be adjusted using the trailing roller so that they only work in the upper level (surface layer) exclusively and the topsoil structure is maintained in the deeper layers. The intensity of the application is influenced by the rpm of the working tools and the travel speed.

Information about the procedure

The initial use requires intensive working. Regular working contributes to a better working result.

Depth guide



The working depth can be continuously adjusted via the trailing roller using the manual spindle so that the adjustment setting suits the respective conditions. The optimal adjustment should be deep enough that plants are completely uprooted and as flat as possible so that only the top level is loosened. As a general rule, it should be as deep as necessary and as flat as possible.



User tip

Tips & tricks

It is best to work in slightly damp conditions in order to minimise the generation of dust. Hot weather conditions following the use of the unit bring especially successful results because the drying of the plants simplifies the subsequent cleaning.

Path maintenance unit

Overview of types and compatibility

WALK-BEHIND TRACTOR MODEL			REX	MONDO	SWISS	MONTA M141	MONTA S141	MONTA M161	MONTA S161	VAREA M141	VAREA S141	VAREA M161	VAREA S161	VAREA M231	VAREA S231	ORBITO
Attachment name	Art. no.															
Path maintenance unit WP 90	1679		-	•	•	-	-	-	-	•	•	•	•	•	•	•
Options																
78/80 mm attachment flange	281930		-	-	•	-	-	-	-	•	•	•	•	•	•	•
52/54 mm attachment flange	281929		-	•	-	-	-	-	-	-	-	-	-	-	-	-

Application

The maintenance of water-bound surfaces is an integral part of caring for both public and private areas.

The statutory provisions and approvals relating to the use of chemical weed killers in residential areas are becoming increasingly stringent.

Intended areas of use



Water-bound surfaces



Crushed stone, gravel and grit paths

Working results and aesthetics

After the weeds have been removed, the plant material lies loosely on the surface. This can be collected together, picked up and transported away in an additional working procedure.



The result: Plants pulled out lie on intact layers.

Rotary weed brush

Mechanical removal of weeds
from paved areas Mowing



- Mowing technology
- Forage harvesting
- Mulching technology
- Cleaning
- Tilling
- Winter services
- Transport
- Special applications



Environmentally friendly mechanical removal of weeds from surfaces covered in paving or tarmac



The rotary weed brush is used to remove weeds from large paved surfaces such as paths and spaces covered in paving or tarmac and surfaces covered with composite stone. The cleanliness, safety and protection of structures is thereby maintained. At pavement edges and gutters, drainage functions are retained and the accumulation of sediment is avoided. The procedure uses a mechanical method to pull up the weeds in different directions and deposit them on the surface.



OVERVIEW OF MODELS AND FEATURES

Type	Rotary weed brush WE 90
Working width	90 cm
Weight	143 kg
Additional weights	optional, each weighing 12 kg (max. 5 items)
Chassis	2 wheels, with individual continuously variable height adjustment

Success factors

- Simple and efficient removal of unwanted plant growth from paved areas, pavement edges and gutters
- Purely mechanical process, no need to use any chemical substances
- High manoeuvrability of the device combination also makes it easy to work in areas with many nooks and crannies
- Optimum adaptation to various work situations thanks to different brush attachments and optional additional weights for generating high contact pressures

The right brush attachments for any use



As well as the disk brushes which are used as standard for general use, more aggressive twist knot brushes are optionally available for coarser, less sensitive surfaces, thicker growth and initial applications.



Twist knot brush

Simple replacement of wearing parts

The majority of wear only occurs on the brushes. These are easy to replace. The device is therefore quickly available for use again after a brush change.



Disk brush

Chassis and depth control

The chassis comprises a frame and two feeler wheels with continuously variable height adjustment. The wheels can be roughly adjusted roughly a clamping screw, and a spindle is available for fine adjustments. The entire chassis can be fitted or removed using two folding split pins.



Information about the procedure

If the plant growth is well established, an approach using the rotary weed brush is extremely effective. Using the device at this stage of growth will weaken the plants considerably and slow down the process of them growing back.

Alternating between forwards and backwards movement and also moving sideways during the application produces a good level of intensity.

The hydrostatically driven walk-behind tractors are very manoeuvrable, allowing paths and spaces to be cleared with ease, even in areas which are difficult to access and have many nooks and crannies.

Splash protection

The splash guards reduce the risk of damage in the working environment. The guards can be folded up and can be adjusted to the setting and/or wear condition of the brushes.



Additional weights

Additional weights increase the contact pressure of the brushes on the ground. The additional weights are easy to insert and remove again with just a few manual operations.



Principle of "Working on extensive areas"

The chassis is removed when working on large areas covered in vegetation. The inherent weight of the brush tools of the rotary weed brush provides the contact pressure on the surface. These tools rotate, move the plants in different directions and pull them out of the gaps. The plants are then deposited on the surface.



Principle of "Working along edges"

When working along pavement edges, gutters etc., the chassis is used and one side of the attachment is raised.

The low brush setting then makes it possible to work on the edge or gutter in question intensively. The raised brush has no function during this application.



Counter-rotating brushes – simple device guidance

Since the brushes rotate in opposite directions, sideways-acting force is cancelled out. The combination of devices is therefore easy for the operator to guide with precision at all times.



Rotary weed brush

Overview of types and compatibility

WALK-BEHIND TRACTOR MODEL		REX	MONDO	SWISS	MONTA M141	MONTA S141	MONTA M161	MONTA S161	VAREA M141	VAREA S141	VAREA M161	VAREA S161	VAREA M231	VAREA S231	ORBITO
Attachment name	Art. no.														
Rotary weed brush WE 90 with disk brush	1677	-	-	-	-	-	-	-	-	-	•	•	•	•	•
Options															
Set of twin knot brushes for type 1677	1678	-	-	-	-	-	-	-	-	-	•	•	•	•	•
Attachment flange 78/80 mm for type 1677	281930	-	-	-	-	-	-	-	-	-	•	•	•	•	•
Additional weights each weighing 12 kg for type 1677	281926	-	-	-	-	-	-	-	-	-	•	•	•	•	•

Application

The maintenance of green and paved areas in both public and private areas includes the maintenance of paved surfaces. The statutory requirements and approvals relating to the use of chemical weedkillers in residential areas are becoming increasingly stringent. This mechanical procedure is a good alternative to chemical weedkillers.

Intended areas of use



Sides and edges of paths



Paved paths and spaces

Results and aesthetics

In order to remove weeds, the plant material deposited on the surface can subsequently be collected together, picked up and removed in an additional step if necessary.



The result: Plants pulled out

Weed brush

Mechanical removal of weeds from paved areas



- Mowing technology
- Forage harvesting
- Mulching technology
- Cleaning
- Tilling
- Winter services
- Transport
- Special applications**



For the environmentally friendly mechanical elimination of weeds from edges, sides and paved areas



Edges, sides and paved areas are freed from weeds with the weed brush. The cleanliness, safety and protection of structures is thereby maintained. At pavement edges and gutters, drainage functions are retained and the accumulation of sediment is avoided. The procedure uses a mechanical method to pull up the weeds in different directions and deposit them on the surface.



OVERVIEW OF MODELS AND FEATURES

Art. no.	1743	1744
Type	Weed brush WKB 60	Weed brush WKB 60
Brush diameter	60 cm	60 cm
Weight	65 kg	78 kg
Additional weights	–	fitted
Connection flange	52/54 mm	78/80 mm
Depth guide	Support wheel, height-adjustable with dial	Support wheel, height-adjustable with dial
Brush angle	adjustable in 2 levels	adjustable in 2 levels

Success factors

- Environmentally friendly removal of weeds without the use of herbicides
- Compact and agile attachment, perfect for working along the edge of curbs and sides of paths
- Low power requirement
- Versatile use thanks to adjustable brush angle
- Weed brush with optimum configuration for great results

Interchangeable wire cluster

The wire clusters consist of flat wire strips and fine wires with multiple bends which are held together by a clip. This composition offers very good properties with regard to standstill time, the collection of weeds and plant parts and good results. The individual wire clusters can be quickly replaced with a few manual operations.



Working principle



The brush angle can be continuously adjusted in two levels with a manual spindle for each level. This setting is secured by the clamping lever.

The brush disc is adjusted so that the wire clusters of one half of the circle make contact with the paved ground surface and can collect the weeds. The wire clusters of the other half of the circle are in the air without ground contact, creating a self-cleaning effect. Plant parts, soil material and dirt are deposited on the travel path.



Note

The functional principle is guaranteed even when low pressure is applied. There is a tendency to apply too much pressure to the brush, which leads to high wear.

Chassis and depth control

The support wheel can be adjusted for depth control in order to enable the brush/wire clusters to work and to compensate for the wear on the brushes.



Splash protection

The splash guard reduces the risk of damage in the working environment. The guards can be adjusted to the setting and/or wear condition of the brushes.



User tip

The brush can be easily moved to the side for wire cluster replacement without removing it from the basic appliance.

Tips & tricks

Weed brush

Overview of types and compatibility

WALK-BEHIND TRACTOR MODEL			REX	MONDO	SWISS	MONTA M141	MONTA S141	MONTA M161	MONTA S161	VAREA M141	VAREA S141	VAREA M161	VAREA S161	VAREA M231	VAREA S231	ORBITO
Attachment name	Art. no.															
Weed brush WKB 60, Kersten	1743		-	•	-	-	-	-	-	-	-	-	-	-	-	-
Weed brush WKB 60, Kersten	1744		-	-	•	-	-	-	-	•	•	•	•	•	•	-

Application

The maintenance of green and paved areas in both public and private areas includes the maintenance of paved surfaces. The statutory requirements and approvals relating to the use of chemical weedkillers in residential areas are becoming increasingly stringent. This mechanical procedure is a good alternative to chemical weedkillers.

Results and aesthetics

In order to remove weeds, the plant material deposited on the surface can subsequently be collected together, picked up and removed in an additional step if necessary.



before



after

The high-tech centre

The Rapid business areas

Rapid Technic AG

Industriestrasse 7
CH-8956 Killwangen,
Switzerland

T +41 44 743 11 11
www.rapid.ch



Certified quality

Since 1992, all products have been manufactured in accordance with the Rapid quality management system audited by SQS. All standards are reviewed and refined on an ongoing basis. In the interest of meeting these stringent requirements, Rapid is committed to the continuous professional development of its employees and consistently offers apprenticeship training positions.

Rapid has been developing and manufacturing high-quality single-axle walk-behind tractors and perfectly coordinated attachments in Switzerland since 1926. This makes it easier for people across the globe to carry out many different kinds of work, whatever the time of year. Because the machines are so easy to handle, activities can be carried out safely and efficiently.

Walk-behind tractors and attachments

Thanks to their reliability and flexibility, Rapid walk-behind tractors are loved the world over. Given the large number of different attachments, they can be used efficiently in agricultural, horticultural and market gardening contexts as well as for maintaining green and paved areas.



Custom production

Rapid Technic AG has accumulated experience in cutting, friction stir welding (FSW) and assembly over many years. It is on the basis of this experience that it has built its strategy. We offer our expertise to third-party customers all around the world.

Your Rapid specialist: